

# Proceedings of the 6th National Small Farm Conference

Promoting the Successes of Small Farmers and Ranches



Microsoft account

MEMPHIS COOK CONVENTION CENTER  
SEPTEMBER 18 - 20, 2012 MEMPHIS, TN

# *Proceedings of the 6<sup>th</sup> National Small Farm Conference*

The 6<sup>th</sup> National Small Farm Conference, "**Promoting the Successes of Small Farmers and Ranchers**", was hosted by Tennessee State University, College of Agricultural Human and Natural Sciences and the University of Tennessee. Successes in small farm activities were shared, as well as innovative ideas in research, extension and outreach to strengthen collaboration and partnership among state specialists who work to ensure that small farmers and ranchers not only survive, but also thrive in today's economy. The conference also served as a forum to discuss the results of research geared towards addressing challenges facing small farmers and ranchers. Strengthening partnerships created at the five previous National Small Farm Conferences was a priority for the Memphis meeting.

This conference consisted of short courses, oral and poster paper presentations, exhibits, success stories and educational tours within Memphis and vicinity

Dear Conference Participants:

On behalf of the conference planning committees, our hosts Tennessee State University, the University of Tennessee, conference sponsors, land grant colleges and universities, community-based organizations, USDA Agencies, small farmers and ranchers, foundations, State Small Farm Program Coordinators, USDA Small Farm Coordinators and others, welcome to the Sixth National Small Farm Conference. The conference's theme, "Promoting the Successes of Small Farmers and Ranchers," provides a forum to promote the successes of small farmers and ranchers as well as discuss local, state, regional and national small farm research, extension and outreach issues identified by stakeholders from land grant colleges and universities, community-based organizations, farm communities and others working with small farmers and ranchers. Successful programs and projects will be shared so as to promote and encourage innovative ideas that can be replicated in order to enhance economic opportunities and improve the quality of life for small farmers and ranchers. This Conference builds upon the successes of previous conferences held in Nashville, Tennessee; St. Louis, Missouri; Albuquerque, New Mexico; Greensboro, North Carolina and Springfield, Illinois. This is a train-the-trainer conference consisting of several preconference short courses, and program tracks focusing on: Alternative and Traditional Enterprises; Marketing Opportunities; Outreach to Underserved Communities; Research and Extension Priorities; and Program Planning and Implementation.

Tuesday's opening reception begins with greetings and remarks to set the tone and direction of the conference while providing opportunities for you to network with participants. On Wednesday, the highlights include a keynote followed by farmers' Panel on Small Farm Opportunities and Challenges, and closing out the afternoon with educational tours. Thursday highlights presentations from series of tracks, networking lunch followed by a closing reception, and drawings.

Great thanks to the staff at Tennessee State University, the University of Tennessee, USDA Agencies, the local Planning Committee and the Conference Planning Committee and others for their hard work over the past two years in planning for the 6<sup>th</sup> National Small Farm Conference.

Sincerely,

A handwritten signature in black ink that reads "Denis Ebodaghe". The signature is written in a cursive, flowing style.

Denis Ebodaghe, Ph.D.

Executive Committee Chair & National Program Leader for Small Farms

## Committees and Members

### **Educational Tours Committee**

Organizes and conducts the conference tours; works with Program Committee to include tour schedule in the conference program;

Chair: Fitzroy Bullock, Tennessee State University

Members:

Chris Robbins, Tennessee State University

David Lockwood, University of Tennessee

Kathy Faust, University of Tennessee

Carolyn Banks, Alcorn State University

Anthony Reed, Alcorn State University

Alvin Wade, Tennessee State University

Joshua Idassi, North Carolina A&T State University

### **Success Stories Committee**

Develops guidelines for the submission of success stories, recruits success stories submissions; works with Linda Buchanan to lay out available exhibit space for success story layout on poster boards as well as input written success stories in conference proceedings.

Chair: Alan Galloway, University of Tennessee

Members:

Savi Horne, Land Loss Prevention Project

Cathea Simelton, USDA Office of Advocacy and Outreach

Dorothy Barker, Operation Spring Plant

Charles Smith, USDA Office of the Assistant Secretary for Civil Rights

Karla Martin, USDA Office of Advocacy and Outreach

### **Evaluation Committee**

Develops outcomes and evaluation strategies; develops survey instrument; coordinates collection and summary of evaluation

Chair: Mary Peabody, University of Vermont

Members:

Debi Kelly, University of Missouri

Alexandria Wilson, USDA-NIFA

Grace Perry, Tennessee State University

Tasha Hargrove, Tuskegee University

### **Exhibit Committee**

Develops guidelines and policy criteria for selection of exhibitors, recruits new exhibitors, updates and circulates announcements; responds to inquiries; works with Linda Buchanan and conference venue to lay out available exhibit space.

Chair: Solomon Haile, Tennessee State University

Members:

Louie Rivers, Kentucky State University

Mocile Trotter, USDA Office of Communications

Delores Taylor, USDA Foreign Agricultural Service

Lisa Mason, USDA Office of Advocacy and Outreach

Loretta Miles, USDA Office of Advocacy and Outreach

### **Local Planning Committee**

Works with Fitzroy Bullock and Linda Buchanan to select the site city, hotels; works with Educational Tours Committee; designs and assembles registration packets; works with Marriott Hotel to determine equipment needs; recruits and coordinates on-site volunteers for moderators, A/V for each session, slide pre-viewing room, registration, etc.; secures food for reception and other meals; works with hotel and Program Committee

Chair: Fitzroy Bullock, Tennessee State University

Members:

Linda Buchanan, Tennessee State University

Arvazena Clardy, Tennessee State University

Richard Powell, University of Tennessee

Alan Galloway, University of Tennessee

Cathy Faust, University of Tennessee

Alvin Wade, Tennessee State University

Solomon Haile, Tennessee State University

David Lockwood, University of Tennessee  
Martin Kool, University of Tennessee  
David Perril, University of Tennessee  
Rachel Hendricks, Tennessee State University  
John Ricketts, Tennessee State University  
Annette Wszelake, University of Tennessee

### **Poster Presentation Committee**

Works with the Program Committee to develop the call for posters (includes the criteria for selection); reviews submitted abstracts; works with Program Committee on communications with submitters, poster room layout and time slots; coordinates the poster judging contest (including developing the criteria and the awards)

Chair: Arvazena Clardy, Tennessee State University

Members:

Edoe Agbodjan, South Carolina State University  
Tasha Hargrove, Tuskegee University  
Kim Bradford, USDA-NRCS  
Tracy Jones, USDA-FSA  
Jimo Ibrahim, North Carolina A&T State University  
Robin Brumfield, Rutgers University  
Lavinia Panizo, USDA-Office of Advocacy and Outreach

### **Proceedings Committee**

Compiles and edits poster and oral paper presentations and keynote session speeches; ensures that final product is forwarded to the Web Site Committee to be linked to small farm Web page

Chair: Denis Ebodaghe, USDA-NIFA

Co-Editors:

Scott Elliott, USDA-NIFA  
Carolyn Banks, Alcorn State University  
Nii Tackie, Tuskegee University  
Beth Nelson, University of Minnesota  
Solomon Haile, Tennessee State University

## **Publicity Committee**

Identifies liaisons with key related organizations and media; drafts and executes media plan to publicize event; drafts and circulates announcements; arranges for media participation/coverage during event; promotes conference

Chair: Kathryn Hill, USDA Office of Communications

Members:

Antonio McLaren, Virginia State University

Shirley Brown, USDA-Office of the Chief Economist

Jo Lynne Seufer, USDA-RMA

Horace Hodge, Prairie View A&M University

Sharon Hestvik, USDA-RMA

Clifton Peters, Alcorn State University

Jim Hafer, Chief Dull Knife Community College

Willie Pittman, Farmer

Debi Kelly, University of Missouri

## **Steering Committee**

Meets monthly by conference call, increasing to bi-monthly during quarter preceding the event; drafts and meets timeline and budget; oversee committee work; drafts Committee call agendas; runs calls and drafts/circulates follow-up notes

Co-Chairs: Denis Ebodaghe, USDA-NIFA and  
Fitzroy Bullock, Tennessee State University

Members:

Arvazena Clardy, Tennessee State University

Albert Essel, Delaware State University

Alan Galloway, University of Tennessee

Anusuya Rangarajan, Cornell University

Alvin Wade, Tennessee State University

Annette Wszelake, University of Tennessee

Carl Butler, USDA-Farm Service Agency

Carmen Humphrey, USDA-Agricultural Marketing Service

Cathy Faust, University of Tennessee  
Cinda Williams, University of Idaho  
Deborah Cavanaugh Grant, University of Illinois  
David Wiggins, USDA-Risk Management Agency  
Dawn Mellion Patin, Southern University  
Chongo Mundende, Langston University  
Fitzroy Bullock, Tennessee State University  
Garry Stephenson, Oregon State University  
Geraldine Herring, USDA-Office of the Assistant Secretary for Agriculture  
Edmund Gomez, New Mexico State University  
Gladys Gary Vaughn, USDA-Office of the Assistant Secretary for Agriculture  
Jim Hafer, Chief Dull Knife Community College  
James Hill, Sustainable Agriculture Research and Education Program  
Debi Kelly, University of Missouri  
Ken Johnson, USDA-Animal and Plant Health Inspection Service  
Lou Ann Kling, National Tribal Developmental Association  
Linda Buchanan, Tennessee State University  
Lindia Howell, USDA-Food Safety Inspection Service  
Lorette Picciano, Rural Coalition  
Marion Simon, Kentucky State University  
Mary Peabody, University of Vermont  
Mickie Swisher, University of Florida  
K. B. Paul, Lincoln University  
Ray Mobley, Florida A&M University  
Rachel Hendrix, Tennessee State University  
Richard Powell, University of Tennessee  
Solomon Haile, Tennessee State University  
Vivian Dickson, USDA-Natural Resources Conservation Service  
Robert Zabawa, Tuskegee University

### **Program Committee**

Met on a regular basis to plan, coordinate and implement the conference's program agenda.

Program Chair: Dawn Mellion-Patin, Southern University



MEMBERS:

Andy Larson, Iowa State University  
Anusuya Rangarajan, Cornell University  
Ariel Lynn Agenbroad, University of Idaho  
Berran Rogers, University of Maryland  
Cheryl Bailey, USDA-Forest Service  
Charles Whitaker, Charles Whitaker Farm Group  
Carolyn Banks, Alcorn State University  
Deborah Cavanaugh Grant, University of Illinois  
Doris Newton, USDA-Economic Research Service  
Daisy Garrett, Mississippi Association of Cooperatives  
Duncan Chembezi, Alabama A&M University  
Betsy Wieland, University of Minnesota  
Fred Broughton, South Carolina Department of Agriculture  
Roy Bullock, Tennessee State University  
Jeff Fisher, Ohio State University  
Fidelis Okpebholo, Virginia State University  
Gary Lesoing, University of Nebraska  
Henry Searcy, USDA-Rural Development  
Henry Grant, University of Florida  
John Clendaniel, Delaware State University  
John O'Sullivan, North Carolina A&T State University  
John Jefferson, USDA-Farm Service Agency  
John Ricketts, Tennessee State University  
Debi Kelly, University of Missouri  
Kim Bradford, USDA-Natural Resources Conservation Service  
Lindia Jones-Howell, USDA-Food Safety and Inspection Service  
David Lockwood, University of Tennessee  
Mapy Alvarez, National Immigrant Farming Initiative  
Michelle Radice, USDA-National Agricultural Statistical Service  
Marietta Pannell, USDA-National Institute of Food and Agriculture  
Monika Roth, Cornell University  
Peter Jackson, USDA-Grain, Inspection Packers and Stockyards Administration  
Richard Molinar, University of California-Davis  
Ronald Brown, USDA-Risk Management Agency  
Sanjun Gu, Lincoln University  
Shirley Brown, USDA-Office of the Chief Economist

Solomon Haile, Tennessee State University

**Web Site**

Web Site was developed by Dr. Solomon Haile of Tennessee State University

Initiative Web Design by Linda McGee, Clemson University

## Table of Contents

Letter from Secretary Vilsack to Conference Participants	28
Keynote Speech, Sonny Ramaswamy, USDA-National Institute of Food and Agriculture	30
Oral Presentations    Session 1	35
Session 1 A	35
<b>Track/Session: Alternative and Traditional Enterprises/Vegetable Production Systems</b>	35
Session 1 B	47
<b>Track/Session: Marketing Opportunities/Food Hubs Panel Discussion</b>	47
Session 1 C	47
<b>Track/Session: Outreach to Underserved Communities/ New and Beginning Farmers Part I</b>	47
Session 1 D	51
<b>Track/Session: Program Planning and Implementation/New and Beginning Farmers Part I</b>	51
Session 1 E	51
<b>Track/Session: Research and Extension Priorities/Small Farm Systems Part I</b>	51
Session 1 F	55
<b>Track/Session: Alternative and Traditional Enterprises/Financials Part I</b>	55
<b>Local Food and Entrepreneurial Enterprises Provide Opportunities for Communities and Beginning Farmers</b>	57
Session 1 G	59
<b>Track/Session: Marketing Opportunities/Overseas Markets</b>	59
Session 1 H	66
<b>Track/Session: Outreach to Underserved Communities/Innovative Solutions</b>	66

Session 1 I	70
<b>Track/Session: Research and Extension Priorities/Managing Agricultural Risks Part II</b>	70
Session 1 J	80
<b>Track/Session: Research and Extension Programs/Issues and Opportunities</b>	80
Session 1 K	84
<b>Track/Session: Marketing Opportunities/Farmers Markets</b>	84
<b>Values for the Engagement in CSAs and Farmers' Markets</b>	84
<b>James R. Farmer</b> , Earlham College; <b>Charles Chancellor</b> , Indian University; <b>Jennifer Meta-Robinson</b> , Indiana University	84
Session 1 L	88
<b>Session: Outreach to Underserved Communities: Risk Management Plans</b>	88
<b>Developing Personal Risk Management Plans for Limited Resource and African American Producers in Arkansas and Mississippi</b>	89
<b>Laurence Crane</b> , National Crop Insurance Services, <b>Albert Essel</b> , Delaware State University, <b>Henry English</b> , University of Arkansas and <b>Anthony Reed</b> , Alcorn State University, Pine Bluff	89
Session 1 M	93
<b>Track/Session: Program Planning and Implementation/Leadership Development</b>	93
<b>Partnerships and Collaborations: Keys to the Success of the Small Farmer Agricultural Leadership Institute</b>	93
<b>Dawn Mellion-Patin</b> , Southern University A&M College, Baton Rouge, LA	93
Session 1 N	93

<b>Track/Session: Research and Extension Priorities/Using Technology in Programming</b>	93
<b>Going Digital: Lessons learned from the “eXtension Entrepreneurs and Their Communities” Team</b>	93
<b>Mary Peabody</b> , University of Vermont, Burlington, <b>Connie Hancock</b> , University of Nebraska, Lincoln, <b>and Glenn Muske</b> , North Dakota State University, Bismarck	93
<b>Going Digital: Lessons learned from the “eXtension Entrepreneurs and Their Communities” Team</b>	93
Session 2	96
Session 2 A	96
<b>Track/Session: Alternative and Traditional Enterprises/National Goats</b>	96
Session 2 B	96
<b>Track/Session: Marketing Opportunities/Enhancing Marketing Avenues – Part I</b>	96
<b>Marketing Channels Used by Small Farmers in Tennessee</b>	100
<b>Tegegne, F., S. Pasirayi, S. P. Singh, E. Ekanem, P. Illukpitiya</b> , Tennessee State University, Nashville, TN	100
<b>Marketing Channels Used by Small Farmers in Tennessee</b>	100
<b>Tegegne, F., S. Pasirayi, S. P. Singh, E. Ekanem, P. Illukpitiya</b>	100
<b>Tennessee State University, Department of Agricultural and Environmental Sciences,</b>	100
<b>Nashville, TN</b>	100
Session 2 C	103
<b>Track/Session: Outreach to Underserved Communities/</b>	103

<b>General Education: How to's Part II</b>	103
<b>Extension Programs Targeted to Assist Sustainable Farming and Diversified Agriculture Operations</b>	103
<b>Gary Lesoing, Jessica Jones, Lindsay Chichester, Vaughn Hammond, Elizabeth Sarno, John Wilson, University of Nebraska, Lincoln, and William Powers, Nebraska Sustainable Agriculture Society</b>	103
<b>Extension Programs Targeted to Assist Sustainable Farming and Diversified Agriculture Operations</b>	104
<b>Outrunning the Horizon: How What You Do Today Can Shape Your Farm's Future</b>	106
<b>Jeffrey Jandura, Land Loss Prevention Project</b>	106
<b>Addressing Farm and Land Losses for Minority Farmers and Forest Landowners in Virginia</b>	111
<b>Peter Callan, Virginia Cooperative Extension, Culpeper, Michael Lachance, Agriculture and Natural Resources, Lovington, Robert Andrew Branan, The Branan Law Firm, Hillsborough, NC</b>	111
Session 2 D	119
<b>Track/Session: Program Planning and Implementation/Successful Educational Programs Part II</b>	119
<b>The USDA NRCS Organic Initiative: Supporting Conservation on Organic Farms</b>	119
<b>Sarah Brown, Oregon Tilth</b>	119
<b>Reducing Risk on Idaho Small Farms and Ranches through Innovative Whole Farm Planning Education</b>	125
<b>Cinda Williams, Ariel Agenbroad, Collette DePhelps, M. Lines, D. Green, Mary Rohlring, and C. Madsen, University of Idaho Extension, Latah County</b>	125

<b>Reducing Risk on Idaho Small Farms and Ranches Through Innovative Whole Farm Planning Education</b>	125
<b>Challenges for Improved Crop Insurance for Small Farms: The Case of Whole Farm Adjusted Gross Revenue Lite</b>	128
<b>Jeff Schahczenski, National Center for Appropriate Technology</b>	128
<b>The Case of Whole Farm Adjusted Gross Revenue Lite</b>	129
Session 2 F	132
<b>Track/Session: Alternative and Traditional Enterprises/Niche Farming</b>	132
<b>Earth Healing with Bamboo – Ecoservices, Bioremediation, Agroforestry</b>	132
<b>Adam Turtle and Sue Turtle, Earth Advocated Research Farm</b>	132
<b>Earth Healing with Bamboo</b>	133
<b>Adam Turtle and Sue Turtle</b>	133
<b>Introduction</b>	133
Benefits or Services	134
Session 2 G	137
<b>Track/Session: Marketing Opportunities/Collaborative Efforts</b>	137
<b>Exploring Efficiencies in the Merger of the New Generation Growth Cooperative and Farmers’ Market to Enhance Vibrant Rural Economies and National Food Security</b>	137
<b>Emmanuel I.S. Ajuzie, Lincoln University, Jefferson City, MO</b>	137
<b>Exploring Efficiencies in the Merger of the New Generation Growth Cooperative and Farmers’ Market to Enhance Vibrant Rural Economies and National Food Security</b>	137
<b>Track/Session: Outreach to Underserved Communities/New and Beginning Farmers Part II</b>	140

Session 2 I	146
<b>Track/Session: Programming Planning and Implementation/Managing Agricultural Risks Part II</b>	146
<b>Growing Farms Online: Comprehensive Education for Beginning Farmers and Ranchers in an Online Environment</b>	147
<b>Garry Stephenson, Melissa Fery, Amy Garrett, Melissa Matthewson, Kristin Pool, Nick Andrews, and Maud Powell, Oregon State University Small Farms Program, Corvallis, OR</b>	147
<b>Education Webinar Enhancement</b>	151
<b>Mark Kepler, Agriculture, Fulton County, Steve Engleking, Purdue University, LaGrange County</b>	151
Session 2 J	153
<b>Track/Session: Research and Extension Priorities/Enhancing Farm Opportunities</b>	153
<b>Emerging Opportunities to Enhance Small Farm Viability in the Northeast</b>	154
<b>Anu Rangarajan, Violet Stone, Matthew Goldfarb, Erica Frenay, and Michelle Podolec, Cornell Small Farm Program, Cornell University, Ithaca, NY</b>	154
<b>Soil Sampling to Direct Farm Management on Diverse Organic Farms</b>	157
<b>Doug Collins, Craig Cogger and Andy Bary, Washington State University</b>	157
Session 2 K	162
<b>Track/Session: Marketing Opportunities/Marketing Resources</b>	162
<b>Using Project Sign Post: A Direct Farm Business Regulation Outline and Farm To School FAQs to Assess Farm-to- School Readiness</b>	163



<b>Deborah Cavanaugh-Grant, Karen Bonsignore, Lissa Burt, Bill Cook, Justin Jacques and Nichole Meister, University of Illinois</b>	163
<b>Direct Online Marketing of Food Specialty Products: A Resource for Business Owners and for Educators</b>	167
<b>Connie Hancock; Jay Jenkins; Jennifer Nixon, University of Nebraska – Lincoln; Glenn Muske</b>	167
North Dakota State University; <b>Mary Peabody, University of Vermont</b>	167
Session 2 L	171
<b>Track/Session: Outreach to Underserved Communities/Management Strategies Part III</b>	171
<b>Working with Small Farmers Promoting Sustainable Livestock Production System</b>	171
<b>Uma Karki, Nar K. Gurung, Jeffery Moore, and Alphonso Elliott, Tuskegee University, Tuskegee, AL</b>	171
<b>Responding to the Needs of Socially Disadvantaged Livestock Producers</b>	175
<b>Niki Whitley, Michelle Eley, John O’ Sullivan, Roberto Franco, Keesla Moulton, Keith Baldwin, James Hartsfield and Amanda Hatcher, North Carolina A &amp; T State University</b>	175
Session 2 M	177
<b>Track/Session: Research and Extension Priorities/Economic Analysis</b>	178
<b>Economic Based Decision Support to Promote Sustainable Livestock Enterprises</b>	178
<b>Joan Fulton, Anna Lee Allcorn, Nicole Olynk, Purdue University</b>	178
Session 2 N	181
<b>Track/Session: Marketing Resources/Ethnic Markets</b>	182

<b>Meat Goat Enterprises as an Alternative Source of Income for Tennessee Small Farmers</b>	189
<b>Azubuike Ezeadum, Enefiok Ekanem and Mary Mafuyai-Ekanem, Tennessee State University</b>	189
Session 2 O	194
<b>Track/Session: Program Planning and Implementation/Enhancing Farm Opportunities</b>	194
<b>Organic Certification: History, Roles, and Process</b>	194
<b>Sarah Brown, Oregon Tilth, Corvallis, OR</b>	194
<b>Bridging the “Digital Divide” of Small Farm Families and Limited-Resource Farmers Through Computer Literacy and Technology</b>	198
<b>Courtney T. Owens, Cooperative Extension Program, North Carolina A &amp; T State University</b>	198
Session 2 P	201
<b>Track/Session: Research and Extension Priorities/Beginning Farmers</b>	201
<b>Sustainable Development</b>	201
<b>Jennifer Taylor, College of Agriculture and Food Sciences, Florida A &amp; M University</b>	201
Oral Presentations    Session 3    1:30 PM - 3:00 PM	218
Session 3 A	218
<b>Track/Session: Marketing Opportunities/Marketing Trends Part III</b>	218
<b>Bundling Value for Wisconsin Farmers with Market Relationships</b>	218
<b>Ronald Doetech, Solutions in the Land, LLC, Poplar Grove, IL</b>	218
<b>The New FaR<sub>x</sub>macy: Increase Profitability by Teaching Customers to Eat their Vitamins</b>	223

<b>Theresa J. Nartea, Virginia State University Cooperative Extension, Petersburg, VA</b>	223
Session 3 B	224
<b>Track/Session: Outreach to Underserved Communities/Immigrant Farmers</b>	224
<b>Helping Small, Latino, and Hmong Growers to Profit from New Values Based Marketing Channels</b>	224
<b>Gail Feenstra and David Visher, University of California Sustainable Agriculture Research and Education Program (SAREP), Agricultural Sustainability Institute, University of California Davis-Davis, CA</b>	224
<b>Outreach and Assistance to Hmong Farmers in Southwest Missouri</b>	225
<b>Sanjun Gu, Nahshon Bishop, and Sarah Becker, Lincoln University Cooperative Extension, Jefferson City, MO</b>	225
Session 3 C	228
<b>Track/Session: Program Planning and Implementation/ New and Beginning Farmers Part I</b>	229
<b>Rutgers Cost Accounting Program Now Tracks Cash Flows</b>	229
<b>Robin G. Brumfield and Christina Gouliamberis, Rutgers, The State University of New Jersey, New Brunswick, NJ</b>	229
<b>Growing Farms: The Impacts of Oregon’s Beginning Farmer Program</b>	233
<b>Kristin Pool, Garry Stephenson, Nick Andrews, Melissa Fery, Amy Garrett, Melissa Matthewson, and Maud Powell, Oregon State University Small Farms Program, Corvallis, OR</b>	233
Session 3 D	237
<b>Track/Session: Research and Extension Priorities/Small Farming Systems Part II</b>	237

<b>Livestock Integrated Parasite Management in North Carolina</b>	237
<b>Niki Whitley, Ph.D.*, Keesla Moulton, Ph.D., Roberto Franco, Allison Cooper<sup>1</sup> and Rene Jackson</b>	237
North Carolina A&T State University, Greensboro, North Carolina, 27411, <sup>1</sup> Orange County Animal Control and Shelter, Hillsborough, North Carolina	237
<b>Research and Extension Highlights of the New Integrated Pest Management Program at</b>	240
<b>Lincoln University of Missouri</b>	240
<b>Jaime C. Piñero</b> , Lincoln University Cooperative Research and Extension, Jefferson City, MO	240
<b>Development of Intelligent Spraying Systems for Tree Crop Production</b>	244
<b>Heping Zhu, Richard Derksen, Charles Krause, Hongyoung Jeon, Jiabing Gu, Xiang Dong, and Weidong Jia</b> , USDA-ARS Application Technology Research Unit, 1680 Madison Avenue,	244
Wooster, OH; <b>Erdal Ozkan</b> , Department of Food, Agricultural, and Biological Engineering,	244
The Ohio State University, Columbus, OH; <b>Mike Reding and Chris Ranger</b> , USDA-ARS Application Technology Research Unit, Horticultural Insect Laboratory, Wooster, OH; <b>Luis Canas</b> , The Ohio State University Ohio/OARDC, Wooster, OH; <b>Jim Locke</b> , The Ohio State University Extension,	244
Painesville, OH; <b>Stan Ernst</b> , USDA-ARS Application Technology Research Unit,	244
Greenhouse Production Research Laboratory, Toledo, OH; <b>Randy Zondag</b> , The Ohio State University, Columbus, OH 43210; <b>Amy Fulcher</b> , University of Tennessee, Knoxville, TN; <b>Robin Rosetta</b> , Oregon State University	

Extension, Aurora, OR; <b>Yu Chen, Hui Liu, and Yue Shen</b> , The Ohio State University/OARDC, Wooster, OH	244
Session 3 E	253
<b>Program</b>	253
<b>Track/Session: Marketing Opportunities/MarketMaker</b>	253
<b>MarketMaker: An Electronic Network that Connects Farmers, Processors, Distributors,</b>	253
<b>Food Retailers and Consumers</b>	253
<b>Ronald Rainey</b> , University of Arkansas, Little Rock, AR; <b>Darlene Knipe and Richard Knip</b> , University of Illinois Urbana Champaign	253
Session 3 G	256
<b>Track/Session: Program Planning and Implementation/</b>	256
<b>New and Beginning Farmers Part II</b>	256
<b>Growing Agripreneurs: Educating Beginning Farmers on a University Teaching Farm</b>	256
<b>Maud Powell</b> , Oregon State University Small Farms Program	256
Session 3 H	260
<b>Track/Session: Research and Extension Priorities/Specialized Services and Technologies</b>	260
<b>Bundling Elements of Federal Support Programs for Underserved Small Farming Communities and Rural Microbusinesses/Enterprises in Selected Southern States: A North-South Institute, Inc. Experience</b>	260
<b>Samuel W. Scott</b> , North-South Institute, Inc,	260
Session 3 I	264
<b>Track/Session: Marketing Opportunities/Value Added Products</b>	264
<b>Local Meats and Local Meat Networks</b>	264

<b>Lauren Gwin, Oregon State University, Corvallis, OR</b>	264
<b>Using a Transportation Alliance to ‘Buy-Local’ and ‘Sell-Local’ by Small Environmental and Food Horticultural Farms</b>	269
<b>Forrest Stegelin, University of Georgia, Athens, GA</b>	269
Session 3 J	274
<b>Track/Session: Marketing Opportunities/Value Added Products</b>	274
Session 3 K	279
<b>Track/Session: Outreach to Underserved Communities/ eXtension Communication &amp; Marketing</b>	279
Session 3 L	279
<b>Track/Session: Outreach to Underserved Communities/General Education: How to’s</b>	279
<b>Keeping the Reach in Outreach</b>	279
<b>Barbara Norman, Michigan Food and Farming Systems, East Lansing, MI</b>	279
Session 3 M	281
<b>Track/Session: Research and Extension Priorities/Managing Agricultural Risk IV</b>	281
<b>Nitrogen Management in Organic Vegetables</b>	281
<b>Nick Andrews and Dan Sullivan, Oregon State University, Corvallis, OR</b>	281
Oral Presentations    Session 4	287
<b>Track/Session: Alternative and Traditional Enterprises/Organic Practices</b>	287
<b>The Financial Performance of Dairy Systems Across the U.S.A.</b>	288

<b>Thomas S. Kriegl, University of Wisconsin Center for Dairy Profitability</b>	288
Session 4 B	291
<b>Track/Session: Marketing Opportunities/Women in Agriculture</b>	291
Session 4 C	291
<b>Track/Session: Outreach to Underserved Communities/USDA Collaborations &amp; 2012 Ag. Census</b>	291
<b>Successful NASS-CBO Partnership Initiatives</b>	292
<b>Hubert Hamer, USDA/ERS, Washington, DC; Ginger Harris, USDA/NASS, Louisville, KY; Michelle Radice, USDA/NASS, Washington, DC</b>	292
Session 4 D	294
<b>Track/Session: Outreach to Underserved Communities/Farm Service Agency</b>	294
Session 4 E	294
<b>Track/Session: Research and Extension Priorities/Next Generation of Farmers</b>	294
<b>Identifying Barriers that Prevent Hispanic/Latino Farmers &amp; Ranchers in Washington State from Participating in USDA Programs and Services</b>	295
Session 4 F	299
<b>Track/Session: Alternative and Traditional Enterprises/Funding Opportunities</b>	299
<b>Funding Opportunities</b>	299
<b>Panelists: Denis Ebodaghe, USDA-National Institute of Food and Agriculture; James Hill, Sustainable Agriculture Research and Education Program, Marion Simon, Kentucky State University, Frankfort, KY</b>	299
Session 4 G	299

<b>Track/Session: Marketing Opportunities/Social Media</b>	299
Session 4 H	299
<b>Track/Session: Outreach to Underserved Communities/Management Strategies Part I</b>	300
<b>New Faces on Old Places: Knowing your Small Farm Clientele</b>	300
<b>Jeff Fisher and Tony Nye, The Ohio State University</b>	300
<b>Utilizing Pasture Walks to Provide Education and Outreach to Small Farmers and Ranchers</b>	302
<b>Mike Turpin, USDA / Natural Resources Conservation Service</b>	302
<b>Connecting Socially Disadvantaged Farmers and Forest Landowners with Resources</b>	305
<b>Whitaker Small Farm Group, Charles Whitaker, Garner, NC</b>	305
Session 4 I	307
<b>Track/Session: Program Planning and Implementation/Building Capacity</b>	307
Session 4 J	307
<b>Track/Session: Research and Extension Priorities/Managing Agricultural Risks Part I</b>	307
<b>Risk Management Needs of Historically Underserved Farmers</b>	307
<b>H.L. Goodwin, Jr., Sandra Martini, L. Paul Goeringer, and Ron Rainey, University of Arkansas Cooperative Extension Service, Fayetteville, AR</b>	307
<b>The Role of Small Farms in Controlling Runaway Food Issues and Its Environmental Impacts</b>	312
<b>Ali Mohamed and Denis Ebodaghe, USDA / National Institute of Food and Agriculture</b>	312
Session 4 K	319



<b>Track/Session: Outreach to Underserved Communities/Outreach Effectiveness at USDA-Natural Resources Conservation Service</b>	319
Session 4 L	319
<b>Track/Session: Outreach to Underserved Communities/An Overview of the Office of Advocacy and Outreach</b>	319
<b>Panelists: Dexter L. Pearson, Associate Director, USDA Office of Advocacy and Outreach and Karla Martin, USDA Office of Advocacy and Outreach</b>	319
Session 4 M	319
<b>Track/Session: Outreach to Underserved Communities-Tools and Practices</b>	319
<b>U.S. Forest Service – Climate Change and Agroforestry: Tools and Practices</b>	319
<b>Panelists: Richard Straight, David Cleaves, Cheryl Bailey, USDA National Agroforestry Center &amp; U.S. Forest Service</b>	319
Session 4 N	319
<b>Track/Session: Outreach to Underserved Communities/Risk Management Agency’s Farm Safety Net</b>	319
Session 4 O	319
<b>Track/Session: Outreach to Underserved Communities/2012 Farm Bill</b>	319
<b>From Plow to Pen: Embracing a Coalition-Based Approach to Achieve Equity for Historically Underserved Farm Communities in the 2012 Farm Bill Negotiations</b>	320
<b>Panelists: Tracy Lloyd McCurty and Lorrette Picciano, Rural Coalition, Savonala Horne, Land Loss Prevention Project, Rudy Arrendondo, National Latino Farmers and Ranchers Trade Association, and John Zippert, Federation of Southern Cooperatives</b>	320

<i>POSTER PRESENTATIONS</i>	326
ALABAMA	326
ARKANSAS	326
DELAWARE	327
DISTRICT OF COLUMBIA	329
FLORIDA	331
IDAHO	332
KENTUCKY	333
LOUISIANA	334
MAINE	336
MISSOURI	340
NEW JERSEY	343
NEW MEXICO	344
NORTH CAROLINA	346
OHIO	354
PENNSYLVANIA	355
TENNESSEE	355
UTAH	358
WASHINGTON	358
WISCONSIN	360
<i>Exhibits</i>	363
Alabama	363
Arkansas	363
California	366
Delaware	366

District of Columbia	367
Florida	375
Georgia	377
Kentucky	378
Louisiana	379
Maryland	380
Mississippi	382
New York	382
North Carolina	383
Oklahoma	385
Oregon	385
Tennessee	386
Washington	387
<i>INTERNATIONAL</i>	388
Austria	388
<i>SUCCESS STORIES</i>	390
DISTRICT OF COLUMBIA	390
FLORIDA	393
IOWA	393
KENTUCKY	394
LOUISIANA	395
MARYLAND	396
MASSACHUSSETS	396
MISSOURI	397
NEW YORK	399

OKLAHOMA	400
TENNESSEE	400
TEXAS	402
WASHINGTON	403

## Proceedings Contents

# Letter from Secretary Vilsack to Conference Participants



United States Department of Agriculture

Office of the Secretary  
Washington, D.C. 20250

September 17, 2012

Dear Colleagues,

On behalf of the U.S. Department of Agriculture (USDA), I'd like to welcome you to the 6<sup>th</sup> National Small Farm Conference.

Today, America continues to face a historic drought that's having a particularly strong impact on small-scale livestock, dairy, and specialty crop producers. But thanks to your innovative spirit, business sense, and willingness to always learn more, we're seeing agriculture persevere through a hard time.

President Obama and I understand the value of such a strong, diverse agriculture sector in America. And so, USDA has been hard at work to help small producers succeed. We're helping you expand your marketing opportunities. USDA's *Know Your Farmer, Know Your Food* initiative, which we launched in 2009, is helping to grow local and regional markets for food and connect producers with consumers. We have helped expand the number of farmers markets nationwide by more than 60 percent since 2008. We've supported food hubs, more than 200 of which today are helping small farmers aggregate their products to reach larger buyers. And this year, we'll be awarding \$3.5 million in "Farm to School" grants to bring healthier, local food to America's children.

We've supported new infrastructure to assist small-scale producers. Since 2009, nearly 7,400 producers have used USDA support to install hoop houses and extend their growing season. We've coordinated efforts to certify and build mobile slaughter facilities. And we recently signed the first agreement to allow small meat processors to ship products across state lines, easing the regulatory burden you face in making ends meet.

We're helping small farmers get started and keep growing. USDA's Farm Service Agency has made more than 131,000 loans totaling more than \$18 billion in credit for family-sized operators to get started in agriculture and meet regular operating expenses. And, once fully implemented, USDA's new microloan program will expand even more credit for small farms and ranches.

Through USDA's Beginning Farmer and Rancher Development Program, we have supported training for more than 40,000 new farmers and ranchers since 2009, and we recently announced additional funding under the program. USDA has also provided nearly 500 Value-Added Producer Grants to help expand and diversify income sources for farm and ranch businesses.

An Equal Opportunity Employer

6<sup>th</sup> National Small Farm Conference  
Page 2

Finally, we stand in support of all farmers and ranchers in a time of great policy uncertainty. President Obama and I continue to urge Members of Congress to pass a comprehensive, multi-year Food, Farm and Jobs Bill that would support millions of farmers, ranchers, and producers—no matter their size—while helping USDA strengthen rural communities.

As you take advantage of this important opportunity to learn about the many ways for small-scale producers to grow and thrive, know that USDA is working hard to help you every day. Please never hesitate to ask for our assistance. Thank you for your commitment and for your partnership.

Sincerely,

  
Thomas J. Vilsack  
Secretary

# Keynote Speech, Sonny Ramaswamy, USDA-National Institute of Food and Agriculture

## KEYNOTE SPEECH

Dr. Sonny Ramaswamy, Director

USDA-National Institute of Food and Agriculture

Washington, DC 20250

Thank you.

Welcome to the **6<sup>th</sup> National Small Farm Conference.**

Greetings from **Secretary Tom Vilsack** and **Deputy Secretary Kathleen Merrigan**, who are **passionate** supporters of Small farms endeavors. Indeed, Secretary Vilsack has sent a **letter** to the Small Farms Conference that is being **distributed** to the participants of this conference.

Theme of this conference: “**Promoting the Successes of Small Farmers and Ranchers.**”

I want to address the question of how we **create and sustain** small farmers and ranchers:

But, before I do that, I would like to provide the **context** for why we need small farms.

There are two significant contexts that have an impact.

These are issues related to what I call the “New Economy and the Global Challenges.”

The **new economy** is defined as the “**evolution** of developed countries from an **industrial/manufacturing-based, wealth-producing economy into a service-sector, asset-based economy**, brought about by globalization and currency manipulation by governments and their central banks, following strategic changes.”

However, in relation to the food and agricultural enterprise, I think the new economy includes: **global competition; reduced carbon footprint; sustainable, organic, “locavore”**(someone who prefers to

eat locally-produced food); reduced use of resources; demographic changes; population; anti-intellectual; and anti-science biases in society.

**Global Challenges:** Food, water, environment, climate change, energy, poverty, health, education.

Indeed, the **drought** seen in a significant portion of our country is a harbinger of things to come and **approaches** we must use in dealing with the same.

To address many of these challenges, we need a **portfolio** of approaches, including **Small Farms**.

There are a **multitude of efforts** that enable **success** of small-scale farmers and ranchers. These are at the local, state, regional, and national levels.

It ranges from **NGOs (non-governmental organizations)** to the **private sector** to Cooperative **Extension Service** and **land-grant universities**, to the **federal** government.

The **land-grant university** endeavors are in three realms:

- **Discovery** of new knowledge
- **Translation and delivery** of that knowledge in the form of **solutions**
- And, last but not least, creating a **pipeline** of not just the **researchers** and **Extension** personnel, but also the **future farmers** and ranchers.

Need a **convergence** of a number of factors for a **successful** small farming and ranching enterprise: **Knowledge, land, credit, markets, business plans, sound production practices, education and training**.

These are the **purview** of land-grant universities. Most, if not all, serve as a **convener**, a **leverager**, and as a **one-stop-shop** for small farm and ranching enterprises.

At the federal level, **USDA** has a number of **programs** that support small farmers.

The **Obama Administration and USDA** have **promoted** efforts to support farms and ranches of all sizes and products because **every farm contributes** to the strength of an American agriculture sector that today is thriving.



- **Expansion of markets** to help small producers increase their bottom line and diversify their marketing and production.
- **Strengthening local and regional food systems** – helping farmers of all types and sizes take advantage of these new opportunities.
- **New investments** to create infrastructure to benefit small producers.
- And we continue to work toward **bringing more farmers and ranchers into agriculture**, helping them to get started and keep growing.

A couple of examples about *Expanding markets and connecting producers with new marketing opportunities*

- The **Know Your Farmer, Know Your Food (KYF)** initiative is the face of USDA’s commitment to **building up local and regional food systems**, while fostering a **national conversation** about the importance of agriculture and learning about where our food comes from. In 3 years, KYF has helped more producers and businesses tap into the **multi-billion dollar market for local foods**.
- USDA has worked to **expand local and regional marketing opportunities**. Today, there are over **7,800 farmers markets** listed nationwide – a **64 percent increase** over the number of farmers markets in 2008. Direct sales opportunities like farmers markets help keep more of the food dollar in farmers’ pockets and help consumers learn about and appreciate the hard work required to produce food.
- **Winter farmers markets** are also on the rise. Today there are more than **1,800 markets** open during the winter nationwide, a **55 percent increase** over last year and more than double the number in 2010. Winter markets help **reduce some of the volatility** in farmers’ seasonal incomes while improving consumer access to fresh, local food year-round.
- There are over **200 food hubs** in operation nationwide. To support these innovative businesses, USDA developed a new [Regional Food Hub Resource Guide](#) in early 2012.
- USDA’s **Know Your Farmer, Know Your Food Compass** is an electronic guide to USDA **tools for local and regional food systems** ([www.usda.gov/kyfcompass](http://www.usda.gov/kyfcompass)). The compass includes an interactive U.S. map showing local and regional food projects funded by USDA.

Another area USDA is helping small-scale farmers and ranchers is in *improving access to healthy, local food and broadening producers’ customer base*

- In FY11, nearly **\$12 million** was redeemed at farmers markets through the **SNAP (Supplemental Nutrition Assistance Program)**, and USDA provided an additional **\$44.8 million for the WIC**

(Women, Infants, and Children) Farmers Market Nutrition Program and Senior Farmers Market Nutrition Program.

- **Electronic Benefits Transfer (EBT) Cards** at farmers markets is one way that USDA supports healthy food access. By the end of 2011, over **2,400 farmers markets and farm stands were authorized** to accept EBT, an increase of 51 percent over 2010. A new \$4 million **FNS (USDA Food and Nutrition Service) grant program** launched in May 2012 will **expand EBT to more markets** that do not have it currently.
- USDA also **launched** a new **\$5 million Farm-to-School grant** program in 2012 to increase the amount of healthy, local food in schools.

USDA is *helping producers to get started; and keep growing*

- USDA's **Farm Service Agency** has made more than **131,000 loans totaling more than \$18 billion** in credit for family-sized operators to get started in agriculture and meet regular operating expenses.
- USDA has provided support for nearly **7,400 producers to install 'hoop houses'** that help to extend their growing season and diversify their operations.
- Through USDA's **Beginning Farmer and Rancher Development Program**, we have supported training for more than **40,000 new farmers and ranchers since 2009**, with even more producers set to benefit from programs in 2012.
- USDA has provided nearly **500 Value-Added Producer Grants** to help expand and diversify income sources for farm and ranch businesses.
- USDA's **Risk Management Agency** provides \$5 million per year to **conduct training sessions in 17 underserved states** to ensure that traditionally underserved agricultural producers receive assistance in understanding and using risk management tools.
- USDA coordinated efforts to **certify and build mobile slaughter facilities**, while providing additional technical assistance for small meat producers. And, in August 2012, USDA signed the first agreement to allow small meat processors to **ship products across state lines**.

My own agency, the **National Institute of Food and Agriculture** within USDA:

- Provides **funding** to academic institutions, non-governmental organizations, the private sector and individuals.

- Enables the **discovery** of new knowledge about food and agriculture and **delivery** of that new knowledge to end users such as yourselves, and also provides funding for creating the **pipeline** of researchers, Extension personnel, and farmers and ranchers.
- We have a number of **programs of relevance to small-scale farmers and ranchers**. My colleagues **Dr. Denis Ebodaghe, Dr. Hiram Larew, and others**, will provide in **more detail** over the next couple of days.

“**Start2Farm**” is a NIFA-funded one-stop shop **online information clearinghouse** for all beginning farmer and rancher education and training materials. The National Agricultural Library developed and maintains Start2Farm.

The **Sustainable Agriculture Research and Education (SARE)** program provides funding for **train-the-trainer** programs and **mentoring** projects where agricultural professionals work hand-in-hand with producers to perform farm research.

More than **\$18 million** in grants through the **Beginning Farmer and Rancher Development Program** help beginning farmers and ranchers get the training and resources they need to run productive, sustainable farms. Special programs for **veterans** and their families.

**Value-Added Producer Grants** help small producers generate new products, create and expand marketing opportunities, and increase income.

The NIFA funded **Community Food Projects** program also has a role in supporting small farms. This year the program will fund \$4.8 million dollars in grants to communities.

In addition, I want to mention a **number of other** opportunities under the Agriculture and Food Research Initiative.

SBIR Small Farm Program

Small and Medium Sized Farm Program

## Oral Presentations

## Session 1

### Session 1 A

**Track/Session: Alternative and Traditional Enterprises/Vegetable Production Systems**

*High Time for High Tunnels: Making Small Farms Highly Profitable, Dan Drost and Ruby Ward, Utah State University*

### **High Time for High Tunnels: Making Small Farms Highly Profitable**

**Dr. Dan Drost and Dr. Ruby Ward**

**Utah State University**

**Logan, UT**

#### **Introduction**

From 1998 to 2009 there was a loss of 32.2 million farm acres, although the number of farms increased by 7,680. During this same period, farms with sales of less than \$10,000 increased by over 37,000. In Utah there was a decrease of 500,000 acres while increasing the number of farms by 1,100. Over this period, the number of farms in Utah with sales of less than \$10,000 increased by 1,200 (USDA National Agricultural Statistics Service, 2011). The primary reason for this increase in very small farms is changes in land use through urbanization and industrial development.

Pressure to convert farm land to other uses, increasing fuel costs, uncertain markets, changing environments, and diverse consumer tastes and food preferences provides opportunity for small farmer to capture more of the local or specialty foods market (Brumfield et al., 1993). Small farmers need to innovate to supply produce in the local market for longer periods of time each year (Yue and Tong, 2009). The interest in locally grown foods represents an opportunity for small farmers to reconnect with consumers and a rapid increase in farmers' markets and community supported agriculture (CSA) programs throughout the United States create new market outlets.

As growers explore the opportunities to produce crops locally, they need to be able to produce crops earlier in the year and extend that production later into the fall. High tunnels (HT) are walk-in, plastic covered, environment altering structures which allow early and late season production of high quality

fruits, vegetables and flowers (Carey et al., 2009). Though used successfully in other areas of the country, HT are relatively new to the Intermountain West (Carey et al., 2009; Heidenreich et al., 2009). In addition to extending the growing season, HT also increase farm profitability (Conner et al., 2010; Donnell *et al.*, 2011). Rowley *et al.* (2010b) found that use of HT allowed strawberry production to extend from a four-week outdoor production system to almost nine weeks with HT. Berries grown and sold during the off-season command premium prices, which may be two or three times higher than the peak seasonal price (Heidenreich *et al.*, 2009). Hunter *et al.* (2010b) demonstrated similar findings when growing HT tomatoes in Utah. The benefits of HT use is two-fold; first, HT increases the productivity of the land, thus offsetting some land cost; second, it positions the small farm operator to capture a larger market share of locally produced crops.

This paper will focus on the sustainability of very small farms with the use of HT. It will first illustrate how by using HT small farms can be profitable by examining various production scenarios.

## **Data and Methodology**

It is generally assumed that one-or two-acre small farms are not profitable or sustainable due to their size. Therefore small farms need to innovate by integrating HT production of specialty fruits and vegetables to be profitable (Carey et al., 2009). In Utah, with cold, snowy winters and short growing seasons (Moller and Gilles, 2008), the number of options is reduced. However, HT cropping systems have been shown to extend the growing season and allow for double cropping in one production year (Lamont, 2005). A variety of small fruits and vegetables can be grown in HT and direct marketed (Donnell et al., 2011). Our study evaluated June-bearing strawberries, early and late season tomatoes and squash, and winter spinach in an attempt to exploit local shortages. Strawberries require a 1-year production cycle (planted in September; harvested from April-June). Tomatoes and squash could be double-cropped (early tomatoes/late squash, or vice versa) and spinach (or other leafy greens) would follow after tomato/squash to fill the tunnels during the winter (Ernst et al., 2012). These crops were selected as detailed production and sales records were available, the crops are widely grown in local HT, and all been shown to be successful (Carey *et al.*, 2009).

The crops chosen are profitable, of interest to local growers, and have sufficient research to create associated budgets (Drost and Ward, 2011; Ernst et al., 2012; Hunter et al., 2011; Rowley et al., 2010a). Experience has shown that tunnels cannot be managed properly (watered, fertilized, temperature controlled) when more than one crop is grown due to differences in the individual crops' environmental requirements (Black and Drost, 2010). Crops are grown in the soil, the environment carefully managed (temperature control), and no expensive heating and cooling systems utilized to improve early and late season environmental conditions.

Conner *et al.* (2010) noted that budgets focusing on a single crop or HT fail to capture the decision making process used by direct market vendors or account for sales in the actual marketplace. In our analysis we generated returns based on sales at the local markets but did not include the costs of land, equipment, etc. The profit potential shown raises the question of making a sustainable profit with

multiple tunnels on small parcels of ground. Purchasing land to start an HT operation or expand an existing operation is expensive and thus may not be profitable. For those who already own land, considering the full cost (including the opportunity cost) is necessary to examine the long-run sustainability of the system. Each HT (14ft x 96 ft) would require approximately 2,200 sq ft of area to ensure minimal tunnel-to-tunnel shading and sufficient access for equipment. Therefore, 20 tunnels would occupy one acre and these would cover 61.7 percent of the land area. The additional space was not cropped but could be if desired.

We assumed land costs to be \$30,000 per acre, HT construction at \$1,628 (Hunter et al., 2011), \$3,000 was needed to develop the irrigation system, and used equipment -including a truck (\$8,000), small tractor (\$6,000), trailer (\$1,500), tiller (\$1,500), and plastic layer (\$2,000) -are needed as start-up costs (total \$87,370). We assumed that half was paid initially and the remainder financed over 10 years at 8 percent interest. At the end of the 10-year period, the land would have a terminal value of \$30,000.

Annual costs and returns were taken from the respective crop budgets. The owner's labor was assumed to cost \$24,000 and additional labor included at \$10 per hour. Initial returns grew at 1% each year while expenses grew 2% each year (slightly more conservative analysis). The start-up equipment was depreciated over seven years, additional overhead costs were incorporated and a 20% tax rate was used.

A capital budget over 10 years for each option (strawberries, tomatoes/squash, and spinach) was evaluated. The results are sensitive to the commodity prices received and the amount of labor cost assigned to the owner. To examine this and the sensitivity of the results for various levels of owner labor invested, the net present values were obtained over a range of prices and owner labor costs. The prices received for strawberries, tomatoes, squash, and spinach vary depending on the market outlet. For strawberries, most production is 4 to 6 weeks early, so demand is present and the price is fairly stable. Local growers report higher prices in some resort communities. For tomatoes/squash/spinach, the analysis was done using low wholesale pricing, a mid-level pricing (smaller or rural farmers' market), and a high price scenario (high-end farmers' markets found in resort communities). Pricing scenarios are from numbers gathered from growers use these outlets.

## **Results**

The annual cash flow for the tomato/squash/spinach production system is found in Table 1. Findings indicate that one acre of HT double-cropped with tomatoes and squash followed by winter spinach can be quite profitable. The NPV was \$79,568, showing a positive return above the \$24,000 allocated to owner labor, while the internal rate of return (IRR) was 45.8 percent and the modified internal rate of return (MIRR) 22.02 percent. Direct marketing tomatoes/squash for \$2 per pound at a farmers' market and winter spinach (\$2.50) will provide a positive return with a payback period of 2 years. In Utah, growers report early season high-tunnel tomato prices range from \$2 to \$5 per pound depending on the farmers' market location and sell winter greens between \$2 and \$4 per pound. Squash, while deemed less profitable, sells well in local markets. Yields for individual years will vary so we used a conservative average yield values which should be fairly stable over the 10-year planning horizon. The

owner, while providing 50 percent of the initial investment (about \$44,000), with land valued at \$30,000/acre, our scenario would be realistic for land owners with large urban lots that are quite common throughout Utah. Labor is the greatest expense of these HT operations. In addition to the \$24,000 of owner labor, hired labor (over \$32,000) is incurred each year. If the owner did more of the work, profits could be higher. Since the NPV is quite large, HT production systems look promising at a farmers' market or through other direct marketing outlets where returns are greater than in wholesale markets.

**Table 1. Cash Flow (\$) for One Acre of Double-Cropped Tomatoes-Squash and Winter Spinach Using High Tunnels <sup>a</sup>**

Year	0	1	2	3	4	5	6	7	8	9	10
<b>Receipts (\$)</b>											
Tomatoes		68,000	68,680	69,367	70,060	70,761	71,469	72,183	72,905	73,634	74,371
Squash		20,000	20,200	20,402	20,606	20,812	21,020	21,230	21,443	21,657	21,874
Spinach		28,500	28,785	29,073	29,364	29,657	29,954	30,253	30,556	30,861	31,170
											30,000
<b>Cash Inflow</b>		<b>116,500</b>	<b>117,665</b>	<b>118,842</b>	<b>120,030</b>	<b>121,230</b>	<b>122,443</b>	<b>123,667</b>	<b>124,904</b>	<b>126,153</b>	<b>157,414</b>
<b>Expenses and Cash Outflow (\$)</b>											
Down	43,685										
Supplies		18,380	18,748	19,123	19,505	19,896	20,293	20,699	21,113	21,536	21,966
Labor Hired		32,280	32,926	33,584	34,256	34,941	35,640	36,353	37,080	37,821	38,578
Owner Labor <sup>b</sup>		24,000	24,480	24,970	25,469	25,978	26,498	27,028	27,568	28,120	28,682
Operating		4,667	4,760	4,855	4,952	5,051	5,152	5,255	5,361	5,468	5,577
Depreciation		11,295	17,596	12,216	7,118	2,613	2,613	2,613	1,307	0	0
Interest		3,495	3,254	2,993	2,712	2,408	2,080	1,725	1,342	928.776	482.249
Principal		3,016	3,257	3,517	3,799	4,103	4,431	4,785	5,168	5,582	6,028
Taxable Income		46,383	40,382	46,070	51,487	56,322	56,665	57,022	58,701	60,400	90,811
Income Taxes		9,277	8,076	9,214	10,297	11,264	11,333	11,404	11,740	12,080	18,162
Cash Outflow	43,685	95,114	95,500	98,256	100,990	103,641	105,427	107,250	109,372	111,535	119,476
<b>Net Cash Flow</b>	<b>(43,685)</b>	<b>21,386</b>	<b>22,165</b>	<b>20,585</b>	<b>19,040</b>	<b>17,589</b>	<b>17,016</b>	<b>16,417</b>	<b>15,531</b>	<b>14,618</b>	<b>37,939</b>

<sup>a</sup> Returns are based on 20 high tunnels per acre which utilize 61.7% of the space, leaving the remainder for spacing and roads. The returns represent either early tomatoes followed by late squash, or early squash followed by late tomatoes grown late March to mid-October; Spinach grown from late October to mid-March.

<sup>b</sup> Owner labor is listed separately to represent a return for the owner's time. It is not deducted to determine taxable income.

Table 2 shows the economic potential of early strawberries. While the NPV is slightly lower (\$2,505) than for tomatoes/squash/spinach with an IRR of 11.31 percent (MIRR 10.62 percent) the investment is still profitable. Growing just strawberries would take 7 years to recoup the original investment and labor is the largest expense. If more money was borrowed for a strawberry operation, it appears unrealistic for the producer to be fully recouping the investment.

**Table 2. Cash Flow (\$) for One Acre of Strawberries Using High Tunnels<sup>a</sup>**

Year	0	1	2	3	4	5	6	7	8	9	10
<b>Receipts (\$)</b>											
Strawberries		87,090	87,961	88,841	89,729	90,626	91,532	92,448	93,372	94,306	95,249
Terminal Value											30,000
<b>Cash Inflow</b>		<b>87,090</b>	<b>87,961</b>	<b>88,841</b>	<b>89,729</b>	<b>90,626</b>	<b>91,532</b>	<b>92,448</b>	<b>93,372</b>	<b>94,306</b>	<b>125,249</b>
<b>Expenses and Cash Outflow (\$)</b>											
Down	43,685										
Supplies		10,473	10,682	10,896	11,114	11,336	11,563	11,794	12,030	12,271	12,516
Labor Hired		26,410	26,938	27,477	28,027	28,587	29,159	29,742	30,337	30,944	31,562
Owner Labor <sup>b</sup>		24,000	24,480	24,970	25,469	25,978	26,498	27,028	27,568	28,120	28,682
Operating		4,667	4,760	4,855	4,952	5,051	5,152	5,255	5,361	5,468	5,577
Depreciation		11,295	17,596	12,216	7,118	2,613	2,613	2,613	1,307	0	0
Interest		3,495	3,254	2,993	2,712	2,408	2,080	1,725	1,342	929	482
Principal		3,016	3,257	3,517	3,799	4,103	4,431	4,785	5,168	5,582	6,028
Taxable Income		30,751	24,731	30,403	35,807	40,631	40,966	41,319	42,995	44,695	75,111
Income Taxes		6,150	4,946	6,081	7,161	8,126	8,193	8,264	8,599	8,939	15,022
Cash Outflow	43,685	78,210	78,317	80,789	83,233	85,589	87,075	88,593	90,405	92,251	99,870
<b>Net Cash Flow</b>	<b>-43,685</b>	<b>8,880</b>	<b>9,644</b>	<b>8,052</b>	<b>6,496</b>	<b>5,037</b>	<b>4,457</b>	<b>3,854</b>	<b>2,967</b>	<b>2,055</b>	<b>25,379</b>

<sup>a</sup> Returns are based on 20 high tunnels per acre which utilize 61.7% of the space, leaving the remainder for spacing and roads. The returns represent “June-bearing” strawberries, which can be produced for eight weeks.

<sup>b</sup> Owner labor is listed separately to represent a return for the owner’s time. It is not deducted to determine taxable income.

These results suggest that the “one-acre urban farm” can be quite profitable provided there are appropriate marketing outlets. The sensitivity of the results to prices received for tomatoes, squash, spinach, and strawberry and the value of the owner labor was also evaluated. Table 3 shows the NPVs for a range of crop prices and owner labor and the amount of hired labor was not changed. With owner labor valued at \$0, HT operations selling at wholesale prices are not profitable. This is consistent with the finding of Donnell *et al.* (2011). This indicates that direct markets and the higher prices they command are needed to make a small one-acre HT farm cost-effective. Wholesale prices do not cover out-of-pocket direct expenses for tomatoes, squash and spinach so additional market outlets need to be identified (Table 3).



**Table 3. NPV (\$) of One Acre of High Tunnel Tomatoes, Squash, Spinach and Strawberries <sup>a</sup>**

Price	Value of Owner Labor (\$)				
	-	12,000	24,000	36,000	48,000
<b>Tomatoes, Squash, Spinach at Various Prices <sup>b</sup></b>					
\$0.75 - \$0.62 - \$0.68	(122,010)	(201,520)	(281,020)	(360,530)	(440,030)
\$2 - \$2 - \$2.50	165,300	85,820	6,300	(73,210)	(152,710)
\$5 - \$3 - \$4	736,870	657,370	577,860	498,360	418,850
<b>Strawberries</b>					
\$4/\$3	161,510	82,010	42,240	2,510	(77,000)
\$6/\$4	300,420	220,910	141,240	61,920	(17,610)

<sup>a</sup> Returns are based on 20 high tunnels per acre which utilize 61.7% of the space, leaving the remainder for spacing roads. The returns represent either early tomatoes - late squash or early squash - by late tomatoes. Winter spinach occurs from October to March.

<sup>b</sup> Prices are based on a low wholesale pricing scenario (typical of outdoor field production), a mid-level farmers' market scenario (smaller rural setting) and a high-end farmers' market (more affluent or resort community). Strawberries are mostly produced out of season and command a higher more fixed price with sales reflecting rural and resort community.

At a mid-level pricing structure, owner labor at \$24,000 can be profitable. There are 36 farmers' market outlets throughout Utah (UDAF, 2011) and prices vary with attendance and location. For example, the resort communities of Park City or Moab, UT, have higher prices than smaller rural markets like Logan or Price, UT. With higher market prices (\$5 per pound tomatoes, and \$3 squash, and \$4 spinach), even \$48,000 owner labor value has a very high NPV (\$418,850). This demonstrates that the findings are very sensitive to markets and prices. Yue and Tong (2009) found that while 83% of survey recipients want "fresh, safe locally grown produce", 65% thought lower prices to be "somewhat" or "very" important when making their purchases. Therefore, to make a profit, small farmers need to assess farmers' markets, local pricing and competition. If high-end markets are available, the return on investment can be quite large.

Strawberries valued at \$4 per pound out-of-season \$3 per pound when field-grown outdoor berries are available was profitable at \$36,000 owner labor. These prices were quite sustainable in mid-size markets, such as Logan, UT. Several growers report prices for early and in-season strawberries at "resort" markets selling for more than \$6 per pound. Their customers cite better flavor, local, and fresh as the main purchasing points. Yue and Tong (2009) also noted affluent customers were concerned less with price.

## Conclusion

Our analysis based on existing production budgets suggests that there is the potential for additional producers to run HT operations and make reasonable profits on small urban farms. Growers will need to direct market, explore other market outlets, have the necessary HT production skills and create unique HT production scenarios. With premium prices, the profits are considerably higher for greater levels of grower labor utilized. Overall, the number of acres needed to meet market demand is small and roughly 20-50 producers could theoretically capture 5-10% of the market. HT also provides diversification

opportunities for growers to produce and sell in rural areas, if a large portion of the local population can be attracted as customers.

## References

- Black, B. and D. Drost. (2010). "Temperature management in high tunnels." Utah State University Extension. Online. Available at [https://extension.usu.edu/files/publications/publication/Horticulture\\_HighTunnels\\_2010-04.pdf](https://extension.usu.edu/files/publications/publication/Horticulture_HighTunnels_2010-04.pdf). [Retrieved Aug 2012].
- Brumfield, R.G., A.O. Adelaja, and K. Lininger. (1993). "Consumer tastes, preferences and behaviors in purchasing fresh tomatoes." *Journal of the American Society for Horticultural Sciences* 118(3), 433-438.
- Carey, E.E., L. Jett, W.J. Lamont Jr., T.T. Nennich, M.D. Orzolek, and K.A. Williams. (2009). "Horticultural crop production in high tunnels in the United States: A snapshot." *HortTechnology*. 19(1), 37-43.
- Conner, D.S., K.B. Waldman, A.D. Montri, M.W. Hamm, and J.A. Biernbaum. (2010). "Hoophouse contributions to economic viability: Nine Michigan case studies." *HortTechnology* 20(5), 877-884.
- Donnell, J., J. Biermacher, and S. Upson. (2011, February 5-8). "Economic potential of using high tunnel hoop houses to produce fruits and vegetables." Paper presented at the annual meetings of the Southern Agricultural Economics Association, Corpus Christi, TX.
- Drost, D. and R. Ward. (2011). "High tunnel early squash budget 2011." Utah State University Extension. Online. Available at <http://extension.usu.edu/agribusiness/files/uploads/specialty/pdf/2011%20Early%20Squash%20High%20Tunnel.pdf> [Retrieved Aug 2012].
- Ernst, T., D. Drost and B. Black. (2010). "Temperature management in high tunnels." Utah State University Extension. Online. Available at [http://extension.usu.edu/files/publications/publication/Horticulture\\_HighTunnels\\_2012-02pr.pdf](http://extension.usu.edu/files/publications/publication/Horticulture_HighTunnels_2012-02pr.pdf). [Retrieved Aug 2012].
- Heidenreich, C., M. Pritts, M.J. Kelly, and K. Demchak. (2009). "High tunnel raspberries and blackberries." Cornell University, Dept. of Horticulture. Online. Available at [www.fruit.cornell.edu/berry/production/pdfs/hightunnelsrasp2009.pdf](http://www.fruit.cornell.edu/berry/production/pdfs/hightunnelsrasp2009.pdf). [Retrieved Aug 2012].
- Hunter, B., D. Drost, and R. Ward. (2011). "High tunnel early tomato budget 2011". Utah State University Extension. Online. Available at <http://extension.usu.edu/agribusiness/files/uploads/specialty/pdf/2011%20Early%20Tomato%20High%20Tunnel.pdf>. [Retrieved Aug 2012].
- Lamont, W.J., Jr. (2005). "Plastics: Modifying the microclimate for the production of vegetable crops." *HortTechnology* 15(3), 477-481.
- Moller, A.L. and R.R. Gillies. (2008). *Utah Climate*, 2nd ed. Logan, Utah: Utah Climate Center.
- Rowley, D., B. Black, and D. Feuz. (2010a). "High tunnel June-bearing strawberry budget 2010." Utah State University Extension. Online. Available at

<http://extension.usu.edu/agribusiness/files/uploads/specialty/pdf/2010%20Strawberry%20high%20Tunnel%20.pdf>. [Retrieved Aug 2012].

Rowley, D., B.L. Black, D. Drost and D. Feuz. (2010b). "Early-season extension using June-bearing 'Chandler' strawberry plants in high-elevation high tunnels." *HortScience* 45(10), 1464-1469.

United States Department of Agriculture National Agricultural Statistics Service [USDA NASS]. (2011). 2010 Utah Annual Statistics Bulletin. Online. Available at [http://www.nass.usda.gov/Statistics\\_by\\_State/Utah/Publications/Annual\\_Statistical\\_Bulletin/AB10.asp](http://www.nass.usda.gov/Statistics_by_State/Utah/Publications/Annual_Statistical_Bulletin/AB10.asp). [Retrieved Aug 2012].

Utah Department of Agriculture and Food [UDAF]. (2011). Utah Farmers Markets. Online. Available at <http://utahsown.utah.gov/farmersmarkets/index.php>. [Retrieved Aug 2012].

Yue, C. and C. Tong. (2009). "Organic or local? Investigating consumer preference for fresh produce using a choice experiment with real economic incentives." *HortScience* 44(2), 366-371.

***A Case Study on the Uses (and Abuses) of High Tunnels for Fruit and Vegetable Production; Anne Wszelaki, Carlos Miles, and Eric Belasco***

**Annette Wszelaki<sup>1</sup>, Carol Miles<sup>2</sup>, Russ Wallace<sup>3</sup> & Eric Belasco<sup>4</sup>**

**<sup>1</sup>Department of Plant Sciences, University of Tennessee – Knoxville**

**<sup>2</sup>Department of Horticulture & Landscape Architecture, Washington State University**

**<sup>3</sup>Department of Horticultural Sciences, Texas A & M University**

**<sup>4</sup>Department of Agricultural Economics & Economics, Montana State University**

***High Tunnel Basics***

High tunnels, also called hoop houses, are essentially unheated greenhouses. They consist of an arched frame covered with clear plastic. Since these structures are solar heated, there are no heating costs. Depending on the model, the high tunnel may or may not have open ends. Some models provide only an overhead covering to protect from rain, while others are designed for year-round crop production in moderate climates. Four-season tunnels are often ventilated by opening the doors or ends, and having roll-up or roll-down side curtains. All high tunnels are tall enough to stand in, many models accommodate a small tractor for land preparation, and the crops are grown in-ground with drip irrigation. High tunnels range in price from \$1.50 to 3.00 per square foot. In recent years, the USDA National Resources Conservation Service (NRCS)-Environmental Quality Incentive Program (EQIP) Seasonal High Tunnel Initiative ([www.nrcs.usda.gov/wps/portal/nrcs/detailfull/national/programs/?&cid=stelprdb1046250](http://www.nrcs.usda.gov/wps/portal/nrcs/detailfull/national/programs/?&cid=stelprdb1046250)) has provided cost-share funds for nearly 2,500 tunnels in 43 states. In Tennessee, the Agricultural Enhancement Program also provides Tennessee producers cost-share for long-term investments (<http://www.tn.gov/agriculture/enhancement/>).

***Crop Benefits of High Tunnel Production***

Producing crops in high tunnels allows for extending the growing season, either by planting earlier in the spring and harvesting later in the fall for warm season crops, or planting year-round for some cool season crops. High tunnels have been shown to decrease the number of days to harvest for many crops. They also protect the crop against weather extremes and modify the growing environment by shielding plants from rainfall and wind and increasing the temperature at which the plants are grown. Because of the protection from weather extremes and rainfall, high tunnel production has been shown to reduce certain diseases, ease the transition to organic production, and improve crop quality. Most importantly to a grower, high tunnel production can increase crop profitability.

***Project Description and Purpose***

The project described here was a portion of a large, transdisciplinary research and Extension project entitled Biodegradable Mulches for Specialty Crops Produced Under Protective Covers (Reference No: 2009-02484) funded by USDA NIFA's Specialty Crops Research Initiative (SCRI) Program. In this 3-year study, a team of 17 scientists identified strategies for the optimal use of high tunnels in three diverse regions of the United States: eastern Tennessee, Texas High Plains, and western Washington. This team compared the design features of three different types of tunnels chosen by each regional cooperator. In addition, the team evaluated the adaptability of six lettuce, strawberry and tomato cultivars to high tunnel versus open field production in these contrasting environments. More information on the scope and results from the project can be found at <http://mtvernon.wsu.edu/hightunnels/ProjectDescription.html>.

### ***High Tunnel Comparison***

High tunnel models were chosen to best suit the needs of the three crops and climate in each region. In Washington, the Haygrove Solo Series tunnel was used. This is a quonset-style, three-season tunnel (120 ft. long x 27 ft wide, 10 ft peak) with open ends and roll-up sides, and it can accommodate five 3-ft wide raised beds. The advantages of the Haygrove are that it allows for natural ventilation through the ends, is fairly easy to move, and is longer in length than most other models. Disadvantages include suitability for only three-season production, and the necessity to remove the plastic whenever high wind is expected. Also, the height of the sidewalls is too short to allow tractors or other riding equipment to be used along the edges of the tunnel.

In Texas, the Clearspan 'Colossal' tunnel was utilized. The Colossal is a quonset-style, four-season tunnel (96 ft long x 30 ft wide, 13 ft peak) with plastic-covered endwalls and roll-up sides, and it can accommodate six 3-ft wide raised beds. To brace for the expected high winds common in the region, further modifications were made, including anchors in the ground for additional stability and drip tape as straps across the tunnel every 8 ft. to keep the plastic taut during high winds. The advantages of this tunnel were that it was very sturdy for protection against high winds (55-75 mph), allowed for year-round production, was fairly low cost, and the 4-ft tall sidewalls allowed for maximum use of the tunnel area. The disadvantage of the Clearspan 'Colossal' was that once anchored, the tunnel would be very difficult to move if one wanted to rotate sites.

The Golden Pacific Windjammer Series 5,000 tunnel was chosen for Tennessee. This is a four-season tunnel (96 ft long x 30 ft wide, 16 ft peak) with polycarbonate endwalls, roll-down sides, and a gothic arch-shaped roof that is able to accommodate six 3-ft wide raised beds. Additionally, this model included one paraffin sealed vent on each end that would automatically open and close as the temperature rose and fell. Advantages of the Windjammer included its sturdiness, year-round production potential, 6-ft. sidewalls for maximum (and comfortable) use of the tunnel, steel toe boards (instead of untreated wood), and roll-down sides to protect tender plants from cold air in the spring or fall. Disadvantages of this model were its high cost (it was the most expensive of the three types of tunnels used in the study) and the quality. The self-regulating vents, sidewall drop-down assembly, and sliding door mechanism in the end wall all had mechanical issues within the first season of use.

### ***Marketable Yield Gains***

Our preliminary results show that tomato yield more than doubled in the high tunnel compared to open field production at each location, and this benefit increased net returns by \$26,000 on average. Spring-summer production of high tunnel lettuce resulted in a 20 percent decrease in yield due to bolting and tipburn, indicating that a shift in the high tunnel production season either to fall or early spring is necessary. Gains in strawberry marketable yield varied widely by location. In 2011, in Tennessee, marketable yield was over three times greater in the high tunnel as compared to the open field. In Texas, marketable yield was over eight times greater in the high tunnel system. In contrast, in Washington, there was only a 2 percent overall increase in marketable yield in the high tunnel versus the open field.

### ***High Tunnels Reduce Risk***

High tunnels are designed to mitigate the impact of extreme weather events, such as dampening the impact of strong winds, reducing the potency of hail storms, mitigating the impact of prolonged drought through increased water retention, and guarding against prolonged and extreme heat/sunlight. Therefore, in addition to increasing yields, the increased fixed costs associated with high tunnels can be thought of as an insurance premium. In the 3 years of the project, several extreme weather events occurred in two of the locations, and the impact of each event was lessened through the use of high tunnels. In 2011 in Tennessee, hail severely damaged the open field strawberry crop, whereas the high tunnel protected the crop from the hail. In the Texas High Plains, where high winds are commonplace, high tunnels allowed for production of strawberry, lettuce, and tomato each year, whereas open field production was extremely difficult. In western Washington, increased temperature in the high tunnels allowed for tomato production, whereas open field production of tomato is essentially nonexistent.

### ***Early-to-Market Premium***

Another advantage of growing crops in high tunnels is having produce available out-of- season when market prices are typically higher. In this project, tomato harvest began, on average, one month earlier in the high tunnels than in the open field, (early June versus July). This earliness translated to a 25 percent increase in price. Lettuce harvest in the tunnels also started 1 month earlier than in the open field (early May versus June), which translated to a 78 percent price increase, and increased returns by \$2,691 per year. For strawberries in Tennessee and Texas, late-summer/early fall planting allowed for one extra season of production in the high tunnels during November and December, and an earlier spring harvest as compared to the open field. The prices used to make these calculations reflect average prices and such prices often rely on market chains.

### ***Conclusions***

Producers can use high tunnels to increase profits and decrease risk exposure. High tunnels can lead to increased productivity of tomato in summer, and strawberry in fall, winter and spring. Price premiums for these three specialty crops are generally greatest in fall, winter and spring, before or after the traditional production season, which adds another benefit to high tunnel production. Wind damage to high tunnels can be significant; therefore, it is important to select the model based on local wind conditions.

### ***Resources and References:***

Crop Tunnels and Mulch <http://mtvernon.wsu.edu/hightunnels/>

Galinato, S.P., and Walters, T.W., November 2012. 2011 Cost Estimates of Producing Strawberries in a High Tunnel in Western Washington. 8 p. <https://pubs.wsu.edu/ItemDetail.aspx?ProductID=15542>

Galinato, S.P., and Miles, C.A., November 2012. 2011 Cost Estimates of Producing Fresh Market Field-Grown Head Lettuce in Western Washington. Washington State University Extension Publication FS081E. 6 p. <http://cru.cahe.wsu.edu/CEPublications/FS081E/FS081E.pdf>

Galinato, S.P., Miles, C.A. and Ponnaluru, S.S. 2012. 2011 Cost of Producing Fresh Market Field-Grown Tomatoes in Western Washington. Washington State University Extension Publication FS080E. <http://cru.cahe.wsu.edu/CEPublications/FS080E/FS080E.pdf>

Galinato, S.P., Miles, C.A. and Ponnaluru, S.S. 2012. 2011 Cost Estimates of Producing High-Tunnel Tomatoes in Western Washington. Washington State University Extension Publication FS090E. <http://cru.cahe.wsu.edu/CEPublications/FS090E/FS090E.pdf>

Galinato, S.P., Miles, C.A. and Ponnaluru, S.S. 2012. 2011 Cost of Producing Head Lettuce in High Tunnels in Western Washington. Washington State University Extension Publication FS092E. <http://cru.cahe.wsu.edu/CEPublications/FS092E/FS092E.pdf>

Miles, C.A., R. Wallace, A. L. Wszelaki, J. Martin, J. Cowan, T. Walters, and D. Inglis. 2012. Deterioration of potentially biodegradable alternatives to black plastic mulch in three tomato production regions. *HortScience* 47:1270-1277.

Rogers, M., and A. L. Wszelaki. 2012. Influence of high tunnel production and planting date on yield, growth, and early blight development on organically grown heirloom and hybrid tomato. *HortTechnology* 22:452-462.

Wallace, R.W., A. L. Wszelaki, C.A. Miles, J.S. Cowan, J. Martin, J. Roozen, B. Gundersen, and D.A. Inglis. 2012. Lettuce yield and quality when grown in high tunnel and open-field production systems under three diverse climates. *HortTechnology* 22:659-668.

Wallace, R.W. and Webb, C.J., October 2012. Low Tunnel Strawberry Guide for Home Gardeners on the Texas High Plains. Texas A & M AgriLife Research & Extension Center. 9 p. <http://mtvernon.wsu.edu/hightunnels/Content/Low-Tunnel-Strawberry-Guide-for-Home-Gardeners-on-the-Texas-High-Plains.pdf>

## Session 1 B

### Track/Session: Marketing Opportunities/Food Hubs Panel Discussion

*The Financial Performance of Organic, Grazing and Confinement Dairy Farms, Thomas S. Kriegel, University of Wisconsin*

## Session 1 C

### Track/Session: Outreach to Underserved Communities/ New and Beginning Farmers Part I

#### *Oregon's Women Farmers Networks: Support for Women, Success for Farmers*

*Melissa Fery, Melissa Matthewson, Maud Powell, Jen Cramer and Kristin Pool  
Oregon State University Small Farms Program*

The number of women farmers across the country is increasing. According to the 2007 census of agriculture, 30% of all farmers are women and 14% are primary operators, and these numbers are expected to grow in the future. Between 2002 and 2007, women who are principal farm operators increased by 19% (2007 Ag Census, USDA). Despite this dramatic increase in numbers, women farmers continue to be underserved in agricultural education and technical assistance. Social stereotypes often portray farming women as “farmwives” rather than farm operators or decision-makers. Female operated farms tend to be smaller acreage and diversified, but with significantly less value of sales. Often, women farmers feel isolated from their peers. To address the unique needs of women farmers, the Oregon State University (OSU) Extension Service Small Farms Program has established regional women's farm networks that are communities of practice. Communities of practice approach learning as social participation. Their function as an enhancement to learning is well known (Wenger, 1999; Wenger et. al 2002).

Three regional farmer networks in Oregon focus specifically on women producers: the League of Women Farmers (LOWF) is located in southern Oregon, the Willamette Women's Farm Network (WWFN) serves four counties and based in Corvallis and the North Willamette Women Farmer Network (NWWFN) covers the Portland metro area. LOWF was established in 2007, WWFN in 2008 and NWWFN recently formed in 2011.

LOWF's mission is to provide women farmers with opportunities for business networking, expanding knowledge, and socializing in a supportive, open environment. WWFN is a community of women from the central and southern Willamette Valley of Oregon that are actively engaged in farm and ranch



activities. They have joined together to further their knowledge of farm and ranch related issues both in the market place and in agricultural practices. They are working together to enhance their economic self-sufficiency through shared experiences, resources, and visions of how farm work will impact ourselves and our community.

The networks function through the facilitation of OSU Extension faculty, but topics covered are decided by the membership. The networks have fostered peer mentorship and facilitated educational opportunities. Meetings or gatherings consist of farm tours, potlucks, discussions, and educational workshops. In addition, the networks offer skill-building classes to women in activities typically conducted by male farm partners, including welding, fence building, tractor driving and carpentry. To date, over 350 women participate in the networks and their activities. The networks have provided women farmers an environment of support and solidarity counteracting their isolation.

According to Janie Hipp, National Program Leader in Risk Management Education at the USDA, “It is absolutely essential that women come together regularly to share experiences, successes, and failures and to support one another, regardless of what ‘track’ they are on. Training and education are important to improve the ability of our businesses and our families to become and remain successful over the long term” (Hipp 2008).

One WWFN member commented, “Traditionally women have not been the primary decision makers in farming and there is a need for additional support and guidance for women small farmers, particularly with the more mechanical aspects of running a farm. It is also nice to have the support of other women with similar interests.” Another WWFN explained, “When I go to grower meetings, I’m the minority. When I ask a question, often times the answer is directed back to my husband.”

### **Surveying the Women**

Documented impacts of the program include the creation of mentoring relationships between new and seasoned farmers; increased exposure to niche and alternative marketing and production systems; and the development of collaborative relationships between members of the networks in marketing, production, equipment-sharing, and distribution.

In 2012, a comprehensive survey and needs assessment was completed with input from all three networks. Overall, the response rate was 44%. Individually for each network the response rates were WWFN – 63%, LOWF – 38%, and the NWWFN– 32%.

The survey was approved by the Institutional Review Board and conducted on-line using Survey Monkey. There were 28 questions under three broad categories: Logistics and General Thoughts, Programming Needs and Demographics.

#### *Logistics and General Thoughts*

Overall, respondents prefer that gatherings occur on a variety of events held on different days of the week and time of day, over a standard day and time of the week. There was a slight preference (3.5 on a scale of 1 to 5) for the network gatherings to occur seasonally from November through March, over monthly, all year, every other month, all year and quarterly which all ranked 3.4. A majority of women, 60% prefer meeting on Monday through Thursday evenings, though Sunday afternoons was the next most popular time of the week.

Of specific interest, 83% of the participants believe there is a need for a program that addressed the particular needs of women in agriculture. 15% are unsure if a specific program is needed.

When asked what benefits the farmers received as result of being active in their women's network, the responded:

1. More connection with farming community (85%)
2. Increased networking (77%)
3. Increased knowledge (73%)
4. Greater satisfaction with occupation/community (46%)
5. Developed farm skills (42%)
6. Increased customer base (12%)

When asked how has the network benefited you or your farm? The responses to this question were diverse. A few examples are:

- "I participated in classes about using a tractor and basic carpenter skills and I now use those skills."
- "The email list serve has helped me the most. I have connected with other farmers we have helped each other."
- "I haven't attending a meeting yet, but I do feel supported and connected by just reading about what other women in the area are doing."
- "At least two times I was looking for either a piece of equipment or information. I received valuable contacts and answers back from other farmers."
- "Inspiration to tackle new projects and a sense of belonging."
- "My network has increased my confidence."

### *Programming Needs*

When asked what which the top two opportunities available through the work of interest are:

1. Farm walks to learn about different production systems (4.55 out of 5.0)
2. Informational/educational sessions (4.47 out of 5.0)

The participants listed many ideas topics for educational and skill building sessions. Amongst the topics that were suggested by the survey the top three were:

- Mechanical skills (welding, fence building, carpentry) 63.3%
- Farm accounting, recording keeping 62.2%
- Planning and building structures 58.7%

The members are willing to pay for some educational events. Eighty-four percent of the respondents replied ‘yes’ they would participate and be willing to pay a fee for materials or expertise (\$10-\$60), if the topic was of interest to them. In addition, LOWF has established an annual membership fee for participation.

Sixty-four percent of the women who responded are interested in an annual Women Farmers Retreat hosted alternately by each of the three regional women’s networks.

### *Demographics*

The majority of respondents (78%) are currently farming or ranching. Of those, 42 % of the respondents have been farming 1-4 years.

The sizes of farms vary:

- Less than one acre            12.9%
- 1-5 acres                        28.2%
- 6-15 acres                       21.8%
- 16-30 acres                     12.9%
- 30 or more acres               24.2%

Vegetable and fruit production are included in 68% of the farms surveyed and 57% also include livestock production, as well.

Seventy percent are using direct/retail wholesale avenues to market their farm products and 38% are using farmers markets as one of the marketing strategies.

It is important to note that each of the Oregon women networks are unique and function differently based on their membership’s need and request.

Based on the success and impact of these networks, OSU Small Farms faculty will be traveling to four other states in the Northwest to train agriculture professionals to develop women farmer networks.

### **References Cited**

USDA. 2007. Census of Agriculture.

Hipp, J. 2008. Women and Farming, Ranching & Working Lands: Strengthening Their Roles and Preparing for the Future. Small Farm Digest.

Wenger, E., McDermott, R., Snyder, W.M. 2002. Cultivating Communities of Practice. Harvard Business School Press.

Wenger, E. 1999. Communities of Practice: Learning, Meaning, and Identity. Cambridge University Press

## **Session 1 D**

**Track/Session: Program Planning and Implementation/New and Beginning Farmers Part I**

**Agricultural Alternatives;** *Jayson K. Harper and Lynne Kime, Pennsylvania State University*

**A Guide to Farming in Pennsylvania;** *Lynn F. Kime and Jayson K. Harper, Pennsylvania State University*

**So You Want to Farm in Maine;** *Donna Coffin, Kathy Hopkins, and Andrew Plant, University of Maine Cooperative Extension*

## **Session 1 E**

**Track/Session: Research and Extension Priorities/Small Farm Systems Part I**

**Nutrient and Pasture Management: The Alternative Uses of Goats;** *An Peischel, Tennessee State University*

**Small Ruminant Livestock Specialist, Cooperative Extension Program**

**Tennessee State University**

**Nashville, TN 37209**

Goats are an environmentally adaptive species of livestock that is extremely opportunistic and affords the small, limited resource landowner(s) an alternative enterprise. The goat provides food security, high quality protein (for human consumption), biological land enhancement (Peischel, 1999), and many “value-added” products to increase revenue generated on a holistically sustainable rural farm.

Goat production plays a major role in changing farming systems and economic transformation (Peischel, 1999). With the decrease in planted tobacco acreage and income from this traditional crop, the production of goats becomes a natural alternative. Another example is that hog numbers have plummeted drastically since the mid-1980’s, yet those production facilities are still functional on many farms; the structures and land being readily adapted to meat goat production.

There is a misconception among some newer goat producers in that goats are treated as “small’ cows. Limited-experience producers also envision goats eating anything including low quality forages and poor quality hay and still expecting the goat to be an economically viable option. In a survey of Tennessee goat producers, the major areas of concern were forages and pasture management (nutrition), internal parasites, health maintenance programs, and disease management (Peischel, 2004).

The herbivore, through browsing and grazing, affects the plant specie grazed, plant part selected, quality of vegetation grazed, frequency of plants grazed, and degree of vegetation removal. Plant growth requirements are sunlight and the ability of the soil to provide moisture, support, protection and nutrients. The water cycle, driven by solar energy, affects vegetation more than any other single environmental factor. There is a continuum between soil, plant(s), animal(s), and the atmosphere (Peischel, 2000). Environmental factors that affect vegetation distribution in relation to pasturelands management are topography, slope, precipitation, wind erosion, and soil mineral content (Peischel, 2002). In Tennessee, soil mineral deficiencies include copper, magnesium, and zinc (Gill et al., 2004). Important decisions are influenced by the plant community and the factors that influence those communities.

Soil fertility, enhanced by grazing management as it increases the amount of organic matter in the soil and soil nutrients, are recycled by plant roots. Livestock deposit mineral supplements as dung and urine and redistribute nutrients in a grazing system; therefore use good rotation management. Healthy pastures, healthy soil microorganisms -- high quality vegetation. The quantity and quality of vegetation produced in a given time is dependent upon the amount of sun energy a plant captures and converts to tissue. Plants need a leaf area to photosynthesize but a canopy cover of more than 30 percent can decrease vegetation production. As plants are grazed, recovery time is dependent upon soil fertility, season of year, soil moisture content, temperature, degree of defoliation, time of removal, animal specie grazing and residual dry matter.

Residual dry matter is the amount of forage dry matter remaining after a pasture has been grazed. Different plant species vary in recovery time and climate effects recovery time. The correct amount of residual is needed for rapid regrowth yielding higher quality forage so that livestock per acre can be increased as well as animal performance. High residual may also slow recovery rate as sunlight is hard to capture, old leaves are less efficient producers than new leaves, the ratio of non-photosynthetic material to green material and the leaf: stem ratio is stressed. In lightly grazed paddocks with a high residual dry matter, a decreased rate of net photosynthesis available for new growth and the old leaves shade the new ones decreasing production.

Brush, forb, and pasture management are based on the physiology of the plants; biodiversity of plant species in a community is vital (Dabaan et al, 1997 and Taylor et al., 2003).

Livestock used in grazing regimes must be under control where they need to be, how long they are there, and the number of animals present. Caution: do not overgraze the plant and deplete root reserves, nor over rest the plants and decrease biodiversity. In grazing management, use of animal behavior and herd effect allows concentrated animal energy input into a small area for a short period of time. Animals of the same physiological condition need to be foraged as a mob and the quality of feed on offer needs to satisfy their physiological requirements or a mineral supplement provided. Social dominance, herd leadership, and fight distance are considered in grazing management as is sex of livestock, age and breed dominance.

<p style="text-align: center;"><b>Diet Preference Differences</b> (percent of diet)</p>
---

<b>Plant</b>	<b>Horse</b>	<b>Cattle</b>	<b>Sheep</b>	<b>Goat</b>
grass	90	70	60	20
weeds	4	20	30	20
browse	6	10	10	60

Genetic heritability of foraging is important in browse, forb, and pasture operations. The goal is to improve herd performance; the economical production traits of goats and their ability to adapt to environmental stress are crucial.

Grazing management utilizing vegetation species diversification (biodiversity), intensive grazing management and brush/forb and pastureland management decrease internal parasite loads (Min et al., 2004). The immune system is stimulated while enhancing land productivity through the use of livestock is a management goal. The cause of the problem must be resolved, not just treatment for the effect!

There are three major groups of internal parasites; nematodes (roundworms), cestodes (tapeworms), and trematodes (flukes) and each expresses itself differently. Each individual internal parasite has a complex life cycle affected by climatic change, topography, geography, and animal species involved.

Livestock become infected by direct consumption of the infective phase of the larva, skin penetration, or maternal transmission. It is therefore important to know the life cycle to get control of the individual parasite problem. From fecal analysis, the major parasites that need to be considered in your specific geographic area (or farm) can be attained. Parasite loads vary by season, higher during warm, humid, moist times and lower during the fall and winter months and by individual goat. Inhibited larval development (delayed egg laying) can occur until the external environment is prime for larval development. In the warm, moist, humid pasture areas, the first larval phase can hatch in a few hours whereas in the dry areas or during low temperatures, hatching is much slower developing or the larva can die. Once the larva hatches to L3 it has become infective and caution is warranted in grazing pastures.

During the cool part of the day, the larva will be at the plant base and as the temperatures rise during the day, so do the larva, up the stem and onto the leaves. Larva can migrate horizontally to 30cm or more and vertically 2cm to 10 cm (although 2cm to 5cm is most common). Larval migration will be more relevant in the early morning with dew, after a rain, or after irrigating. Consider collecting water droplets (dew, rain) and identify larvae. This identification technique gives a 5 to 7 day advantage to make management changes to avoid deworming.

Pasture management is critical in preventing accumulation of infective larvae. Safe areas are needed for goats to graze to avoid consumption of larvae and re-infestation. Most important times for the doe are 1 month pre-kidding, immediately post-kidding and at weaning for the kids. It can take 12 – 18 months of rest to create a safe grazing area – dependent on climatic conditions. For most farmers, not enough owned acreage is available to pursue that approach and an Integrated Parasite Control Program (IPCP) needs to be established. Or, explore the possibilities of land enhancement, weed abatement, fuels reduction, or cutover timberland management on lands owned by neighbors or public lands (Magadlala et al., 1995, Luginbuhl et al, 1999 and 2000).

In the process of developing this program (IPCP), the producer is changing from chemical (dewormers) control to a biologically sound program to minimize the larval challenge created by parasites. It is a dynamic process, always in the state of change. As grazing areas become healthy, dung beetles and earthworms appear along with parasite antagonists (bacteria and fungi).

Suggestions to keep this synergistic process in motion:

- A. It is extremely important to maintain a higher body condition score on goats. Nutrition management and resistance to parasitism are synonymous. Dietary protein must be readily available, especially for young growing animals and does during late gestation and early lactation. The phosphorus level in dry matter consumed needs to be increased and mineral elements and vitamins in balance (chelated mineral/vitamin mix on offer with free choice kelp meal). Intake of a mineral mix by the goats will vary based upon body weight, age, class, quality, and quantity of forage on offer as well as availability.
- B. To provide the above needed nutrition, plant diversity in grazing areas needs to be maximized to provide the quality and quantity needed during both drought (more protein and phosphorus) and during the wetter times of the growing season (more minerals, especially copper and zinc). Depending upon the location of your specific property, there are various approaches used to attain needed nutrition: 1) Tame pasture- planted high quality mixed grass and forb species for goats (a grazing brome/orchard grass, plantain, chicory, perennial sericea lespedeza, and birdsfoot trefoil). Plant specie selection is important as different chemicals in plants (condensed tannins) have an effect on internal parasites (Min et al, 2003) and leaf structure (chicory) makes it difficult for larva to crawl and cling. Pasture rest is based upon death of infective larvae and management strategy for specific plant utilization. 2) Regrowth from haying and silage making - cut higher than 5cm and graze at no less than 10cm in height. 3) Irrigated pasture - irrigate immediately upon removal of the goats, do not return until vegetation is more than 5cm high and give a longer rest period dependent upon individual internal parasite specie. 4) Brush, forbs and shrubs – a goats first love - stay out on browse as long as possible (the higher the head, the lower the level of internal parasites).
- C. Diversified species grazing (cattle, horses, sheep, and goats) is important as various internal parasites are not cross species contaminating. By diversifying, there is plant selection variation among animals so, a vegetative analysis needs to be completed for a grazing area and animal specie used accordingly. The additive grazing effect from mixed species grazing and increased grazing capacity will depend upon dietary overlap. To maintain an additive effect of both plant and animal species, grazing capacity is based upon the effect of terrain, season, grazing program, stocking rate, and weather which affects production and composition. Do not have an animal species overlap of more than 18 to 30 percent or a non-additive dietary affect is obtained. Be careful of animal species selected as they have the ability to shift diet preference (cattle and sheep) based upon forage availability and during a drought. Goats and sheep in combination are non-additive; whereas goats and cattle; goats and horses; and goats, cattle, and horses are an additive effect.
- D. Strategic use of anthelmintics to minimize parasite resistance and not compromise the immune system of the goat. Do FAMACHA, a FECAL ANALYSIS and PACKED CELL VOLUME before making a decision to deworm. If necessary, deworm the does 3 weeks pre-kidding and immediately post-kidding and at weaning for the kids. Be sure to have defecation times and an area set aside dependent upon the anthelmintic selected based upon internal parasite identification.
- E.

#### Literature Cited

- Dabaan, M.E., A.M. Magadlela, W.B. Bryan, B.L. Arbogast, E.C. Prigge, G. Flores, and J.G. Skousen. 1997. Pasture development during brush clearing with sheep and goats. *J. Range Management*. 50:217-221.
- Gill, W., A. Fisher, C. Lane, C. Richards, D. Jones and J. Neel. 2004. Improving the Mineral Status of Tennessee Cattle. The University of Tennessee, Agriculture Extension Service. Info Series: AS-B 294.
- Luginbuhl, J-M., T.E. Harvey, J.T. Green, M.H. Poore and J.P. Mueller. 1999. Use of goats as biological agents for the renovation of pastures in the Appalachian region of the United States. *Agroforestry Systems* 44:241-252.
- Luginbuhl, J-M., J.T. Green, M.H. Poore, and A.P. Conrad. 2000. Use of Goats to Manage Vegetation in Cattle Pastures in the Appalachian Region of North Carolina. *Sheep and Goat Research Journal*, Vol. 16, No. 3.
- Magadlela, A.M., M.E. Dabaam. W.B. Bryan, E.C. Prigge, J.G. Skousen, G.E. D'Souza, B.L. Arbogast and G. Flores. 1995. Brush Clearing on Hill Land Pasture with Sheep and Goats. *J. Agronomy and Crop Science* 174, 1-8.
- Min, B.R., and S.P. Hart. 2003. Tannins for suppression of internal parasites. *J. Anim. Sci.* 81 Suppl: E102-E109.
- Min, B.R., W.E. Pomroy, S.P. Hart and T. Sahlu. 2004. The effect of short-term consumption of a forage containing condensed tannins on gastrointestinal nematode parasite infections in grazing wether goats. *Small Ruminant Research Journal* (in press).
- Peischel, An. 2004. Survey of Goat Producers throughout Tennessee (unpublished).
- Peischel, An. 2002. Riparian Area Restoration with Kiko Meat Goats: An Ecologically Sound Enterprise, *Goat Rancher*, May.
- Peischel, An. 2000. The Hole that makes up a Whole in: *Holistic Management In Practice*, #69, January/February.
- Peischel, An. 1999. Goats, People and Land Unlimited in: *Holistic Management In Practice*, #66, July/August.
- Peischel, An. 1999. Controlled Grazing with Goats Enhances Land Productivity, *Goat Rancher*, April.
- Taylor, C.A. and S.D. Suhlendorf. 2003. Contribution of goats to the sustainability of Edwards Plateau rangelands. TX Agric. Expt. Sta. Tech. Report No. 03-1.

## Session 1 F

### Track/Session: Alternative and Traditional Enterprises/Financials Part I

#### *Can It Pay To Irrigate Pasture In The North East Part of the USA?*



*Thomas Kriegl, Brian Nischke, and Alex Crockford,  
University of Wisconsin, Center for Dairy Profitability*

## ***Local Food and Entrepreneurial Enterprises Provide Opportunities for Communities and Beginning Farmers***

*Gary Lesoing, Jessica Jones, Lindsey Chichester, and Vaughn Hammond,*

*University of Nebraska-Lincoln*



The increasing demand for local food and the desire of people to support businesses in their own communities have provided opportunities for local entrepreneurs to initiate and expand their businesses. These farmers were highlighted in tours of the region by other farmers, community leaders and ag educators in 2010 and 2011. In 2010 we visited farms and ag businesses around the rural/urban interface of southeast Nebraska. A producer on the edge of Omaha sells a variety of vegetables and integrates fun activities for families during the harvest season, i.e. corn maze, pumpkin patch. The demand for local food has prompted a farmer to open a year round farmers market in Omaha where he consigns local food from area farmers. They also have developed a large CSA in Omaha and are serving a large component of underserved people and providing them with healthy and nutritious local food that they ordinarily would not receive. A number of restaurants and some schools are focusing on using local food, which provides more opportunities for local food production in the urban areas of Nebraska. There are several community gardens in both Lincoln and Omaha, NE that are growing and selling produce. This is providing urban residents and also youth a chance to grow their own food and sell any extra.

Near Lincoln, NE an area farm specializes in greens and flowers, but they also have a goat herd and produce and market their own cheese. This farm markets through a CSA, farmers' markets and whole sale to grocery stores. One farm has an organic grass-based dairy and produces and direct markets cheese.

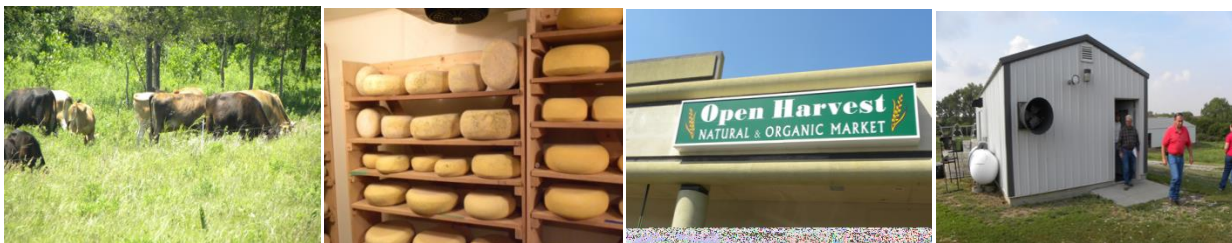

Food coops in the area provide markets for farmers produce and meat. A poultry producer in southeast Nebraska has his own refrigerated truck to deliver his fresh chicken to his customers in southeast Nebraska. He also processes his own chickens, so this provides local jobs for a number of people. Other people have used their talents to initiate other businesses. A Christmas tree farm in rural

southeast Nebraska not only sells Christmas Trees, but also wreaths. This brings employment to local women that make the wreaths. Other local businesses include a buffalo ranch, natural pork producer, grass-fed beef ranch, a vineyard, winery and microbrew, and a number of vegetable producers. These all help spark the local economy, whether it is rural or urban, sometimes bringing new businesses to a community and jobs for local people. These farms and ag businesses have inspired community leaders and ag educators to spread the word and teach others. One of the participants in these tours has gone on to develop his own entrepreneurial enterprise after seeing what others have done and has become very successful in his business. We have actually featured his farm on a tour as well.



## Session 1 G

### Track/Session: Marketing Opportunities/Overseas Markets

#### *Exploring Overseas Market Opportunities*

*Dale Miller*

*Foreign Agricultural Service/USDA*

*Washington, D.C.*

This discussion focuses on USDA programs and services that could help farmers, ranchers and small businesses export their agricultural products. Many United States businesses have discovered the profit potential of exporting. The best way to achieve export success is to formulate an export strategy. Carefully screen target markets or options for market entry. Good planning assures successful exporting, which encourages United States companies to continue to sell to other countries. The Foreign Agricultural Service (FAS) has a brief tutorial to guide the United States food, fish, fiber, and forest product companies who need to develop an export plan at "Recipe for Export Success" (<http://www.fas.usda.gov/agx/basics/tutorial.asp>). FAS offers a variety of services and programs that help small businesses succeed in the global marketplace. From facilitating relationships with potential foreign buyers, to providing technical and financial assistance, FAS's resources and expertise link small businesses to a world of opportunities.

**Market Intelligence:** In addition to its Washington, D.C. staff, FAS has a global network of offices covering more than 150 countries. FAS staff members are the eyes, ears, and voice for the United States agriculture around the world. They analyze foreign market opportunities, prepare trade forecasts, and track changes in policies affecting the United States agricultural exports and imports. This first-hand intelligence can help exporters make informed decisions about how and where to grow their businesses.

**Market Development:** FAS partners with more than 75 cooperator groups representing a cross-section of the United States food and agricultural industry and manages a toolkit of programs to help United States exporters develop and maintain international markets for thousands of products. Programs that benefit small- and medium-sized businesses include: the Market Access Program (MAP), which helps the United States agricultural trade organizations finance overseas marketing and promotional activities such as trade shows, market research, consumer promotions, technical assistance, and educational seminars; and the Quality Samples Program, which helps the United States agricultural trade organizations provide small samples of their products to potential importers in emerging markets overseas; the Emerging Markets Program, which funds technical assistance activities to promote exports of the United States products to emerging markets; and the Technical Assistance for Specialty Crops Program, which funds projects that address sanitary, phytosanitary, and technical barriers that prohibit or threaten the export of United States specialty crops.

**Export Financing:** FAS’s Export Credit Guarantee Program (GSM-102) reduces United States exporters’ financial risk by guaranteeing that they will receive payment for the goods they ship, protecting them in the event of default by a foreign bank to which credit was extended. It also provides importers with favorable credit terms that may help them choose United States agricultural products over those of competing suppliers. The GSM program is available to exporters of: high-value, consumer-oriented, processed products such as frozen foods, fresh produce, meats, condiments, wine and beer; intermediate products such as hides, flour, sweeteners and paper products; and bulk products such as grains, oilseeds and rice.

**FAS Foreign Offices:** FAS’s global network of offices covers more than 150 countries. FAS overseas staff is the eyes, ears, and voice for United States agriculture around the world. FAS staff can introduce United States sellers to potential international customers, provide access to host government officials, and provide country, commodity, and trade policy updates. For a list of FAS offices both in Washington, D.C., and overseas please click on [www.fas.usda.gov/contactus.asp](http://www.fas.usda.gov/contactus.asp).

**State Regional Trade Groups:** FAS supports four State Regional Trading Groups (SRTGs), which in turn assist United States companies with creating and expanding export markets for value-added food and agricultural products. These non-profit organizations, which work closely with state Departments of Agriculture, offer services including:

- exporter training and education;
- analysis of export markets and opportunities;
- trade shows and buying missions; and
- support for international marketing campaigns and product promotion activities.

All promotional activities conducted by the SRTGs are coordinated with FAS Washington and FAS’ overseas offices around the world, and most are funded through the MAP.

SRTG	States	Contact
Food Export USA Northeast	Connecticut, Delaware, Maine, Massachusetts, New Hampshire, New Jersey, New York, Pennsylvania, Rhode Island, Vermont	<a href="http://www.foodexport.org">www.foodexport.org</a> (215) 829-9111
Food Export Association of the Midwest USA	Indiana, Illinois, Iowa, Kansas, Michigan, Minnesota, Missouri, Nebraska, North Dakota, Ohio, South Dakota, Wisconsin	<a href="http://www.foodexport.org">www.foodexport.org</a> (312) 334-9200
Southern U.S. Trade Association	Alabama, Arkansas, Florida, Georgia, Kentucky, Louisiana, Maryland, Mississippi, North Carolina, Oklahoma, Puerto Rico, South Carolina, Tennessee, Texas, Virginia, West Virginia	<a href="http://www.susta.org">www.susta.org</a> (504) 568-5986
Western U.S. Agricultural Trade	Alaska, Arizona, California, Colorado, Hawaii, Idaho, Montana, Nevada, New Mexico, Oregon,	<a href="http://www.wusata.org">www.wusata.org</a> (360) 693-3373

SRTG	States	Contact
Association	Utah, Washington, Wyoming, Guam, America Samoa	

**Technical Assistance:** Navigation certification, documentation and registration requirements can be confusing and time-consuming for many exporters. FAS’s Trade Facilitation Desk serves as a point of contact for exporters, State Departments of Agriculture, and industry cooperator groups seeking assistance and guidance on foreign import requirements. For more information about such requirements and for assistance with detained shipments, contact the Trade Facilitation Desk at (202) 720-CERT or email [exportassist@fas.usda.gov](mailto:exportassist@fas.usda.gov).

**Other U.S. Government Export Assistance Services:**

- I. **ON-LINE TRAINING:** Export.gov and FAS ([www.fas.usda.gov](http://www.fas.usda.gov)) provide a number of courses and
- II. webinars designed to assist small businesses to begin exporting. We suggest that you complete the following export webinars:
  - i. Four Ways to Learn How to Export at [http://export.gov/exportbasics/eg\\_main\\_020141.asp](http://export.gov/exportbasics/eg_main_020141.asp)
  - ii. Export Training and Counseling at [http://export.gov/begin/eg\\_main\\_022469.asp](http://export.gov/begin/eg_main_022469.asp)
  - iii. Export Webinars at [http://export.gov/mrktresearch/eg\\_main\\_018213.asp](http://export.gov/mrktresearch/eg_main_018213.asp)
- III. **EXPORT COUNSELING:** Now that you are more familiar with the export process, you may want to consult with an export assistance counselor. The SCORE Association “Counselors to America’s Small Business” at <http://www.score.org/> provides counseling small businesses interested in expanding business.
- IV. **EXPORT BUSINESS PLAN:** Your next stop is <http://archive.sba.gov/smallbusinessplanner/index.html>, where you will find information and resources to help you develop an export business plan.
- V. **ON-LINE MARKET RESEARCH:** Successful exporting requires careful planning and preparation. The following provide free, current information on foreign market conditions that will help you market smarter!
  - a. Market Research Basics at [http://www.fas.usda.gov/agx/market\\_research/market\\_research\\_basics.asp](http://www.fas.usda.gov/agx/market_research/market_research_basics.asp)
  - b. Market Research Resources at [http://www.fas.usda.gov/agx/market\\_research/market\\_research\\_resources.asp](http://www.fas.usda.gov/agx/market_research/market_research_resources.asp)
  - c. Data and Reports at [http://www.fas.usda.gov/agx/market\\_research/other\\_government.asp](http://www.fas.usda.gov/agx/market_research/other_government.asp)

**Summary:** To learn more about how FAS can help your business build a global business, contact the FAS Office of Trade Programs at (202) 690-3576 or visit the FAS website: [www.fas.usda.gov](http://www.fas.usda.gov) to learn

more about helpful export webinars, points of contact and export programs at both the state and federal levels.

## ***Market Information Preference of Small Farmers In The Rice Value Chain In Kwara State Of Nigeria: Implication For Extension Services***

*Israel Ogunlade<sup>1</sup>, Festus Annor-Frempong<sup>2</sup>, Sijuade. A. Adebayo<sup>1</sup> and Temitope. S. Akanbi<sup>1</sup>*

1. Department of Agricultural Extension and Rural Development

University of Ilorin, PMB 1515, Ilorin, Nigeria.

2. School of Agriculture, University of Cape Coast, Ghana.

### **Introduction**

Rice is a strategic food commodity in the Nigerian economy due to the increasing consumption by people. Despite the government's interventions, the domestic production of rice has not been able to keep up with the demand thereby resulting in considerable rise in importation of rice over the years. For example, Nigeria spent about \$75.6 million on importing rice (CARD, 2009). Apart from inconsistent and appropriate public policy to booster domestic production (Akande, 2002), consumers are ready to pay for quality imported rice. The over dependence on imported rice by consumers in Africa is due to local rice production efficiency, quality and market issues (Nwanze, 2003).

The less attention paid to marketing along the local rice value chain in Nigeria is a major factor leading to poor market quality of local rice in Nigeria. According to Annor-Frempong et. al. (2010), improving local rice processors' access to consumer preferences for rice in the local market will lead to production of quality rice to meet the demands of consumers. Abenakyo et. al (2007) and Odendo ( 2007 ) have emphasized the need to strengthen the capacity of small holder resource-poor farmers to access market opportunities so that entrepreneurial culture in rural communities will be created to ensure that farmers produce what they can market rather than marketing what they produce. Efficient linkages in rice market can contribute to value addition through best processing practices, packaging and branding, reduction in consumer apathy, increase in the market share of local rice and increase in farmers' productivity (Odoemena et al, 2008). Ogunlade and Owolabi(2011) reported that *the intervention by the private firm, OLAM in providing loans and inputs to rice farmers with a focus on extension recommended rice varieties( FARO 41 and 52)* led to increase in farm holdings from 0.5-1.0 ha to 3ha. Farmers have recorded increase in production through new varieties but the income is not commensurate to the bumper harvest. The major question then is what are the market information preferences of small farmers to enable them increase their income from rice production?

### **Purpose and Objectives of the paper**

The main objective of this study was to describe the market information preference of small farmers in the rice value chain in Kwara state, Nigeria, and draw *implication for Extension services*. Specifically, it described the farmers' socio-economic characteristics, examined farmers' preference for information points, investigated farmers' interest in market linkage types, analysed farmers' interest in value addition chain and determined farmers' willingness to pay for market information services.

### **Methods**



The study used a descriptive survey design to randomly select one hundred and sixty-one rice farmers from Edu Local Government of Kwara State, Nigeria, where rice farmers are concentrated. Interview schedule and focus group discussion were used to collect data from the respondents. The data were analyzed and presented using descriptive statistics such as frequency, means and percentage.

### **Findings / Results**

The findings show that majority of the rice farmers were males (94.7%), middle aged (78.3%), married (90.1%), had formal education (66.8%) with average annual income from rice NGN266,464.92 (USD 1,614.6) and had been in rice farming business for an average of 21.34 years. The respondents desire to receive information on marketing, but a little less than average of the farmers (43%) were willing to pay for the latest information in the rice value chain. Of those willing to pay, they were willing to receive information from Extension Agents yearly (44.6%). Only few were willing to pay for any type of service. Of the source where farmers preferred to receive information, majority preferred rural based market information kiosk point (83.1%) followed by district level in rural market (85.1%), rural FM Radio (71.1%) and mobile phone text messages (56.6%).

Farmers showed interest in being linked directly to agro-processors (88.7%), through co-operative society (82.2%), through leading farmers (68.5%), exporters (68%) and retailers (67.7%). The rice farmers mostly preferred information on current market price of rice, location to supply of scarcity so that they will be able to access market at the right time. Moreover they preferred information on level of quality and quantity of rice expected to be supplied to a market, available means of transport, time to supply and scale of measurement due to differences in measuring devices at different places. Farmers preferred information on destoning, polishing, threshing and packaging.

### **Recommendations/implications:**

The study recommended among others, that agricultural extension agents:

- I. Prepare local leaders to share market information per district,
- II. Source fund to finance provision of market information on FM Radio.
- III. Organize farmers into a cell phone network for cheap information dissemination.
- IV. Compile the list of agro-processors and link farmers to them.
- V. Plan for value chain education and provide information free of charge.

### **References**

- Abenakyo, A. , Kaaria, S. and J. Njuki ( 2007 ) Approaches of linking farmers to markets and their influence on income investment options and participation in decision making. A paper presented at Pan Africa Workshop on Service Delivery to Small Holder Farmers organized by **INTER REGION ECONOMIC NETWORK**, Kenya between 18th to 21st May, 2008 at Safari park hotel, Kenya.
- Akande, T. (2002) *An overview of the Nigerian Rice Economy, Agriculture and Rural Development Department*. Ibadan: The Nigerian Institute of Social and Economic Research (NISER)
- Annor-Frempong, F., Shamaki, B.A., Sam-Amoah, L., & Mensah, A.O. (2010): The Application of Action Research Methodology In Improving the Processing of Quality Local Rice In The Dadin-Kowa Community Of Gombe Sate Nigeria. *Journal of Agricultural Extension*. Ilorin: Agricultural Extension Society of Nigeria. (in print)

- CARD (2009) National Rice Development Strategy for Federal Republic of Nigeria- A draft. Available on <ftp://ftp.fao.org/TC/TCA>
- Odeno, M ( 2007) Linking Smallholder Farmers to Markets: The Case Marketing Information in western Kenya. An invited paper presented at Pan Africa Workshop on Service Delivery to Small Holder Farmers organized by **INTER REGION ECONOMIC NETWORK**, Kenya between 18th to 21st May, 2008 at Safari park hotel, Kenya.
- Odoemena, B. Ihedioha, D. Ibana, S. and Okoli, P. (2008) Making rice agribusiness work in sub-humid tropics of Nigeria: The commodity value chain development approach *African Journal of Agricultural Research Vol. 3 (11)*.
- Ogunlade, I., Owolabi, H. O.(2011) Assessment of the Cooperation and Collaboration Initiatives Among Farmers in Duku-Lade Rice Project, Nigeria: Emerging Roles for Agricultural Extension Agents. In the Proceedings of the 45th Conference South African Society for Agricultural Extension held between 30 May – 2 June, 2011 at Tabernakel auditorium, Kimberley, Northern Cape province (P376-380).

## **Session 1 H**

**Track/Session: Outreach to Underserved Communities/Innovative Solutions**

### ***Innovative Solutions to USDA Exclusions***

**Lorette Picciano**

**Rural Coalition/Rural Coalición**

**Rural Coalition/Rural Coalición**

**Washington, D.C. 20005**

**Anna M. Kleiner**

**Institute for Community Based Research**

**The University of Mississippi**

**University, MS 38677**

**Barbara Rater**

**USDA/NRCS**

**Annapolis, MD 21401**

**Jon Hall**

**USDA/NRCS**

**Annapolis, MD 21409-5543**

***Project Objectives:*** The *Innovative Solutions* project was designed to meet the following objectives:

- Develop a template for a County/USDA Service Area profile of producers, production, program participation, and overall county demographics;
- Document and assess the successes and barriers that socially disadvantaged farmers face when attempting to access and receive services from federal farm programs and their administrators;
- Develop recommendations for solutions to barriers and exclusions, that more effectively connect socially disadvantaged producers to USDA in the defined areas; and, Analyze data on the success of the intervention strategies developed to increase equity in USDA programs and prosperity for socially disadvantaged producers.

***Partners and Action Research Framework:*** The project collaborators included the Rural Coalition (RC), Institute for Community-Based Research (with representatives from Delta State University, Southeastern Louisiana University, and The University of Mississippi), Rural Advancement Fund, Oklahoma Black Historical Research Project, National Immigrant Farming Initiative, Accokeek Foundation, National Latino Farmers and Ranchers Trade Association, Mississippi Association of Cooperatives, the Land Loss Prevention Project, Flats Mentor Farm, the Federation of Southern Cooperatives Rural Training and Research Center, and Santa Cruz Farm.. Also involved was a collaboration of federal farm/rural program and university representatives (Annapolis and the Eastern Shore of Maryland). Project activities utilized a community-based research framework to collect and analyze data with people at the grassroots level. At least one partner organization co-sponsored a focus group meeting. Additional activities involved a mentor farm workshop and farmer training session, interagency meetings and related individual interviews, continued inter-organizational collaboration at the National Gathering and Winter Forum, and producer needs assessments documented through interviews.

***Review of Census Data on Agriculture:*** The 2007 Census of Agriculture data on race and ethnicity of farm operators contextualized the project and were extensively discussed and analyzed by project participants.

***Focus Group Research:*** Six focus group discussions with producers in four states explored goals and challenges relating to farming, positive and negative experiences in terms of accessing farm programs/services, and recommendations for improving programs and services to better meet the needs of the producers. Common themes discussed were: shared goals of achieving profitability, sustainability, and inter-generational succession of farms and land; the need for producers to amplify their collective voice in the marketplace and in the policy arena through networking, mentoring, cooperatives, bulk purchases of inputs, and agency recognition of their value; success with some programs/services (e.g. irrigation projects, hoop house projects, and the use of vouchers and Electronic Benefits Transfer machines); and numerous barriers to programs/services, including limited financial resources for farm operations (e.g. for land, labor, and equipment), restricted access to credit and collateral, inaccurate information about programs/services, and agency staff lacking knowledge on needs and wants of producers.

Focus group participants offered recommendations: the need for more staff in field offices to better serve producers; staff that is better trained and more knowledgeable about the programs/services; more clear and consistent procedural steps for accessing and using programs/services; more agency outreach to producers and adequate follow-up to their inquiries; less red tape, and information through agency

websites and on forms found at field offices should be consistent, up-to-date, and specifically labeled for socially disadvantaged farmers.

***Other Innovative Project Activities:***

*Mentor Farm Workshop and Farmer Training:* A workshop hosted by the Accokeek Farm in April 2011; a farmer training session with 14 groups and agencies held in December 2011 in Baltimore, Maryland.

*Interagency and Stakeholder Meetings and Interviews:* Four meetings with agency partners and other stakeholder groups and organizations involved with disadvantaged producers, held in the Maryland/Virginia region; eight interviews with Maryland Memorandum of Understanding about the purpose and effectiveness of the group.

*Producer Needs Assessments:* Ten producers interviewed by partner organizations on USDA experiences.

*National Rural Gathering:* The RC and its numerous partner organizations including Community Based Organizations and government agencies met in June 2011 at its 250-attendee National Rural Gathering in Shawnee, Oklahoma to discuss current issues and develop goals and strategies toward achieving a just and equitable food system.

*Winter Forum:* The RC's Winter Forum (Washington, D.C., December 2011), attended by over 70 farmers, ranchers, farm workers, organizational leaders, and USDA agency representatives, included discussions of strategies for improving outreach and services for socially disadvantaged producers.

***Innovative Solutions -- A Call to Action:*** Based on findings from the community-based action research activities, the following summary of innovations and solutions identified by participants serve as a "call to action."

*Policy and Program Development:* Those working in the policy arena and charged with developing farm programs should have a clear understanding of the needs and motivations of socially-disadvantaged producers, if the public system is going to function in a just and equitable manner. Systematic means of documenting and assessing these producers should be institutionalized in partnership with CBOs and incorporated into the overall framework of farm policy development at accessible public forums where diverse voices can be heard.

*Agricultural Programs:* Improving agricultural programs and who they are capable of serving when implemented will require innovation and flexibility on the part of actors within the system. Issues include utilizing/processing paperwork and evaluating credit worthiness, access to land, risk management, and myriad technological and educational requirements for facilitating success. This necessitates recognition of diversity among producers in the United States, and that a "one-size-fits-all" implementation strategy will not adequately meet the needs.

*Agency Culture:* While the complexities of implementing large-scale programs across numerous agencies and offices are acknowledged, it is of critical importance that agency leaders and staff understand and become committed to serving a diverse clientele representing a variety of interests and experiences. This includes sharing knowledge between agencies and their multiple levels of office staff. Of concern should be fair, equitable, and accurate dissemination of information, and consistent and professional management of requests and follow-up to them. It is important to recognize the varying needs across regions and counties, and how they are influenced by political systems, real estate markets, and the environment.

*Producers at the Grassroots:* Collective wisdom and efficacy are central to advancing the interests of socially disadvantaged producers and achieving a just and equitable food system. The various mentor and demonstration farms and other participatory models of education and knowledge-transfer have been effective toward building the capacity of individuals, farm operations, and communities. As exemplified by the mentor farm workshop and Maryland farmer training workshop discussed in this report, numerous community-based farmer organizations are involved in innovative approaches to agriculture and communicating with public agencies about these activities. However, more inter-organizational collaborative work, and a variety of cooperative production and marketing strategies are needed. For producers, it remains imperative that they share information and technical expertise across organizations and with agency staff and policymakers, as a means of more clearly demonstrating the potential viability of alternatives and the value of diverse producers to domestic agriculture.

## Session 1 I

### Track/Session: Research and Extension Priorities/Managing Agricultural Risks Part II

#### *Organic Studies in the Rio Grande Valley through Short Studies Conducted by College Students 2010-2011*

**Raul T. Villanueva<sup>1,2\*</sup>, Gabriela Esparza-Díaz<sup>1,2</sup>, David Garza<sup>3</sup>, Araceli M. Lopez<sup>3</sup>, Anthony Martinez<sup>3</sup>, Juan Enciso-Siller<sup>3</sup> and Luis A. Ribera<sup>1,4</sup>.** (1) Texas A&M AgriLife Extension Weslaco, (2) Department of Entomology TAMU, (3) South Texas College, (4) Department of Agricultural Economics

#### **Introduction**

Almost 31 million hectares (ha) are currently managed organically by more than 600,000 farms worldwide. In 2005, North America had 2.2 million ha of organic land of 128.5 million ha of land cultivated, and 2 percent of global organic farmers. The Rio Grande Valley in south Texas is an agricultural region, where many farmers have been working in organic production of vegetables. However, information about pest management programs in organic production for this region is scarce. In this project we are currently working with eight studies dealing with horticultural and crop protection. Here, we described only a few of these studies, all dealing with entomological and economical issues and conducted by South Texas College students.

#### **Objectives**

Our aim was to initiate South Texas College students on scientific research in organic farms throughout short studies with the advice of Texas A&M University faculty.

#### **Materials and Methods**

**Mulch effect on pests and predators:** In this study, we evaluated if different types of mulch have any effect on populations of insect pests or their natural enemies. We used non-woven 100 percent polypropylene (Preen Landscape Fabric®; Fig. 1a) and woven polypropylene (Sunfilm Taffeta Mulch®; Fig. 1b) like mulch. Watermelon plants were inspected weekly over the course of 2 months. This study was not destructive; the pest and beneficial insects were not removed from the plants. Data were analyzed with an ANOVA and differences were separated with LSD ( $p < 0.05$ ).

**Damage evaluation of leaf cutting ants in Black Spanish (Lenoir grapes) *Vitis aestivalis*:** A 2-year old black Spanish grape was evaluated for this study. Registered organic pesticides were used to protect the vineyard from leaf eating insects. The products used were Surround® (kaolin), Surround Purshade® (kaolin), Oroboost® (citrus oil), and Spintor Down-Entrust® (spinosad). Although leaf cutting ants were not forecasted as pest (Fig. 2a), this species caused large defoliation to the vines. The damage was rated on all treated plots as: 0 = no defoliation (Fig. 2b), 1 = little defoliation, 2 = light defoliation, 3 = medium defoliation and 4 = heavy defoliation (Fig. 2c). In addition, yield of grapes for all treated plots

was obtained at harvest (fresh grapes; lb). In addition, yield data of all treatments was completed for all plots. A descriptive analysis for damage levels rates and yield was made using ANOVA with homogeneous groups with LSD ( $p < 0.05$ ).

**Pollinators on organic farms:** In this study we used yellow sticky traps placed on 2-m wood poles at 1.5 m heights in organic fields. The study was completed between February 27 and June 5, 2011. Traps were changed every 2 weeks and identification of insects was made using a stereoscope, quantifying the numbers of pollinators (bees, wasps, beetles, butterflies, moths, flies, and midges) per trap.

**Economic feasibility of small organic vegetable farms:** In this study we developed a representative/virtual farm based on the information provided by a panel of three local small acreage organic producers in the Lower Rio Grande Valley. The study examines the 2011 revenue stream on this 3-acre produce operation that relies on three income streams: a Community Supported Agriculture (CSA) Program, farmers markets, and sales to local restaurant establishments. The farm produces about 30 to 50 different vegetable crops on an 11-month growing season, August to June. Under normal growing conditions, each acre of vegetables can supply about 40 to 50 CSA members. The majority of production (80 percent) is used to supply the CSA, with farmers market and restaurant sales each requiring 10 percent of production. The farm is not certified organic, but follows strict organic production practices.

The farm's CSA fee is \$15/week for 24 weeks. Members pay a \$50 membership fee at the beginning of the season for the opportunity to share in the CSA's bounty for the duration of the season. The membership fee is waived for individuals wishing to pay in full for the entire season. CSA members are entitled to weekly delivery of 6-8 items delivered to a pre-determined drop location throughout the growing season. Items are standardized for various forms of produce and examples may include one pound of carrots, one head of lettuce or cabbage, or a pound of greens. The variety of produce included is one of the most positive attributes of the CSA; typically two-thirds of the items are staple foods commonly used in meal preparation, and the other third is more exotic in nature, allowing the member to expand the horizons of their diet. The farm's current production is assumed to support an average of 100 CSA members, and an estimated 10 percent of members pay in full at the beginning of the season.

## **Results and Discussion**

**Mulch effects on pests and predators:** The predatory insect population in watermelon was similar under the two types of mulch (Fig. 3). However, insect pest populations were more abundant on nonwoven compared with woven mulch. Populations of leafminers and whiteflies were greater in the nonwoven polypropylene than woven mulch (Fig. 4). We can hypothesize that light reflectance or temperatures may have an impact on the pest abundance on the nonwoven mulch compared to the woven mulch however, further studies are necessary.



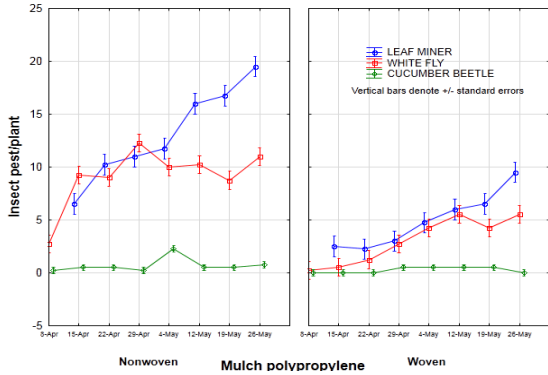

**Figure 3.** Mean insect predator population ( $\pm$ SEM) on organic watermelon with nonwoven and woven mulch

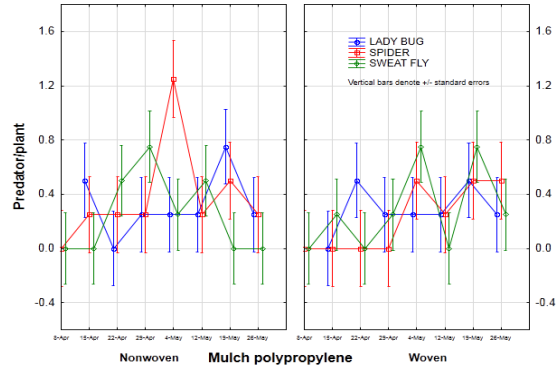

**Figure 4.** Mean insect pest populations ( $\pm$ SEM) on organic watermelon with nonwoven and woven mulch

**Evaluation of leaf cutting ants in grapes:** Only, leaf cutting ants (*Atta texana*) were found causing large defoliation to the vines. Although, spinosad was not used with the purpose of controlling leaf cutting ants, we found that vines sprayed with this product have less defoliation compared with the two formulations of kaolin or citrus oil (Fig. 5). Apparently, the application of spinosad had a positive effect on the yield. A study by Nyamukondiwa and Addison (2011) showed that spinosad .01% bait (dissolved in 25 percent sucrose solution) had potential for the control on two ant species *Anoplolepis custodiens*, and *Crematogaster peringueyi*. Here, we infer that spinosad might deter leafcutting ants feeding.

**Pollinators on organic farms:** Six insect families of pollinators were found in the organic farm on South Texas. There were 1.9 honey bees (Apidae) per trap across all dates, others important pollinators were sphecid, chrysid wasps and sweat bees (Halictidae) (Figure 6). In addition, we found several beetles and moths (Syrphidae, and Sphingidae). The hymenopteran species were cuckoo, red, paper, mud dauber, and threadtail wasps.

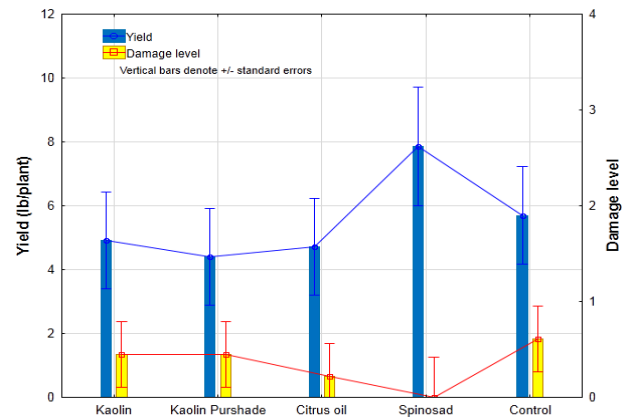

**Figure 5.** Mean yields ( $\pm$ SEM) per vine and damage levels of leafcutting ant mean ( $\pm$ SEM) in a 2-yr old Black Spanish organic vineyard

**Economic feasibility of small organic vegetable farms:** Based on average income levels, the farm's gross receipts from the CSA are estimated at \$40,500. On average, the CSA generates 63.6 percent of the farm's total cash receipts. In addition to produce distributed through the CSA arrangement, sufficient quantities are available to supply farmers markets and restaurants. Based on 2011 levels, sales farmers markets in Harlingen and McAllen, TX, to account for sales of \$18,021 (28.3 percent of total cash receipts). Income is higher from January to June because

leafy greens are a favorite among farmers market patrons; no leafy greens are produced from August to December due to unfavorable growing conditions, thus farmers market sales are lower in those months. Restaurant sales to local establishments account for \$5,185 per year in receipts for the farm. Actual costs of production were utilized in 2011 and were estimated at \$20,063. Labor cost accounts for about 62.2 percent of the total cost of production as two part-time workers are needed to help mainly on the production side of the farm. Not included in the cost of production is the labor provided by the owner which is assumed to work full time.

The farm experiences positive net cash income in 2011 of \$41,318. Net cash income is defined as total cash receipts minus total cash expenses. This figure does not reflect profit, as principal payments on loans, and employment and income taxes must be paid from this value. Moreover, results of a sensitivity analysis examining the contribution of the CSA vs. farmers markets and restaurant sales to the farm's net cash income are reported in Table 2. This sensitivity analysis assumes a constant cash expense. On the vertical axis, reductions on CSA members are shown in increments of 10 percent, while on the horizontal axis reductions on farmers markets/restaurant sales are shown with the same incremental reductions. To illustrate, when both CSA members and farmers markets/restaurant sales present no reduction, the net cash income is \$41,318 as shown previously. However, if there are no CSA members, meaning the only source of revenue is the farmers markets and restaurant sales, the net cash income is only \$820. Conversely, if the only source of revenue were the CSA, then the net cash income would be \$18,113, thus demonstrating the importance of the CSA to the farm's profitability.

Table 2. Sensitivity Analysis of the Contribution of CSA Members vs. Farmers Markets and Restaurant Sales on Farm's Net Cash Income. Shaded areas represent returns above cash expenses (green) and below cash expenses (red).

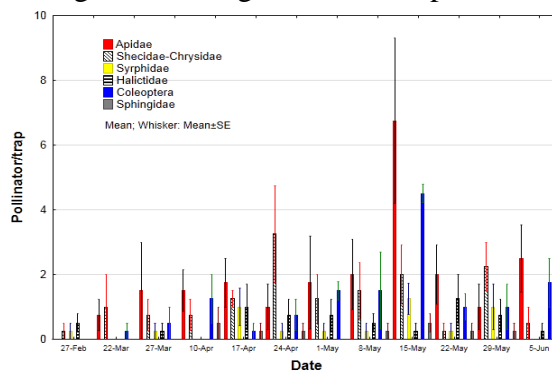

**Figure 6.** Mean ( $\pm$ SEM) distribution of pollinator populations per yellow trap in an organic farm

Net Cash Income												
Reduction in CSA Members	Reduction in FM and Restaurant Sales											
	0%	10%	20%	30%	40%	50%	60%	70%	80%	90%	100%	
0%	\$ 41,318	\$ 38,998	\$ 36,677	\$ 34,356	\$ 32,036	\$ 29,715	\$ 27,395	\$ 25,074	\$ 22,754	\$ 20,433	\$ 18,113	
10%	\$ 37,268	\$ 34,948	\$ 32,627	\$ 30,306	\$ 27,986	\$ 25,665	\$ 23,345	\$ 21,024	\$ 18,704	\$ 16,383	\$ 14,063	
20%	\$ 33,218	\$ 30,898	\$ 28,577	\$ 26,256	\$ 23,936	\$ 21,615	\$ 19,295	\$ 16,974	\$ 14,654	\$ 12,333	\$ 10,013	
30%	\$ 29,168	\$ 26,848	\$ 24,527	\$ 22,206	\$ 19,886	\$ 17,565	\$ 15,245	\$ 12,924	\$ 10,604	\$ 8,283	\$ 5,963	
40%	\$ 25,118	\$ 22,798	\$ 20,477	\$ 18,156	\$ 15,836	\$ 13,515	\$ 11,195	\$ 8,874	\$ 6,554	\$ 4,233	\$ 1,913	
50%	\$ 21,068	\$ 18,748	\$ 16,427	\$ 14,106	\$ 11,786	\$ 9,465	\$ 7,145	\$ 4,824	\$ 2,504	\$ 183	\$ (2,137)	
60%	\$ 17,018	\$ 14,698	\$ 12,377	\$ 10,056	\$ 7,736	\$ 5,415	\$ 3,095	\$ 774	\$ (1,546)	\$ (3,867)	\$ (6,187)	
70%	\$ 12,968	\$ 10,648	\$ 8,327	\$ 6,006	\$ 3,686	\$ 1,365	\$ (955)	\$ (3,276)	\$ (5,596)	\$ (7,917)	\$ (10,237)	
80%	\$ 8,918	\$ 6,598	\$ 4,277	\$ 1,956	\$ (364)	\$ (2,685)	\$ (5,005)	\$ (7,326)	\$ (9,646)	\$ (11,967)	\$ (14,287)	
90%	\$ 4,868	\$ 2,548	\$ 227	\$ (2,094)	\$ (4,414)	\$ (6,735)	\$ (9,055)	\$ (11,376)	\$ (13,696)	\$ (16,017)	\$ (18,337)	
100%	\$ 818	\$ (1,502)	\$ (3,823)	\$ (6,144)	\$ (8,464)	\$ (10,785)	\$ (13,105)	\$ (15,426)	\$ (17,746)	\$ (20,067)	\$ (22,387)	

## Conclusion

The participating college students were able to develop knowledge and discipline to carry on systematic data recording. Involving college students in research is a contribution not only in their professional development but also in research conduction where labor and basic knowledge is scarce. Later, these projects will be analyzed, further discussed and presented to diverse audiences. Regarding the results, these studies represent a compendium of preliminary findings on pest and beneficial insects in transitional organic farms in the Rio Grande Valley; mulch type affected directly insect pest population, spinosad prevents the ant defoliation on vines, and finally the insect pollinator species will be identified later. Finally, a 3-acre organic vegetable farm can be profitable averaging \$41,318 in net cash income per year.

## Acknowledgments

These studies were possible thanks to funds obtained from the Organic Transition Program-NIFA-USDA, grant No. 2010-51106-21803. We thank to Norma Linda and Miguel A. Sanchez of the Monte Alto Vineyard; Diana and Saul Padilla of the Yahweh's All Natural Farm and Garden; and Ray Anzaldúa from the Anzaldúa Farm and Ranch for their cooperation and access to their fields. We also thank Frank Garza, Robert Valdez and Jorge Arellano who collaborated in these studies. \*For more information contact: [gesparzadiaz@ag.tamu.edu](mailto:gesparzadiaz@ag.tamu.edu)

## *Success Indicators for Beginning Small Farmers in North Carolina*

*Anthony K. Yeboah, Jarvetta Bynum, John Paul Owens, Ralphael Okafor, and Younouss Adjibi*

*North Carolina A&T State University*

*Greensboro, NC 27411*

### **A) Objectives**

The overall objective of this research is to identify factors that will contribute to the success of beginning small farmers.

### **B) Purpose**

Small farms account for 91 percent of all farms. Given the importance of small farm viability, this research project focuses on identifying ways to further enhance successful small farming in North Carolina.

Fewer people are working on farms today and this phenomenon has affected North Carolina agriculture. During the past 30 years, the number of farms has decreased from 91,000 to only 53,000. The North Carolina Department of Agriculture reports that 45,200 farms have sales less than \$100,000. Following the national trend, the size of the average farm in North Carolina grew steadily in the second half of the 20<sup>th</sup> century from an average of 123 acres in 1974 to 170 acres today.

There is a great deal of uncertainty about the preservation of small farms, the questions pertaining to this preservation range from the philosophical: If large farms are efficiently supplying our needs, is it right to worry about small ones? To the basic: What is a small farm? and the practical: What can be done to help small farms? (Mayerfeld, 2004).

North Carolina farms vary widely in size and other characteristics, ranging from very small retirement and residential farms to establishments with sales in the millions of dollars. Farming continues to be a distinctive industry in part because most production, even among very large farms, is carried out on family-operated farms whose operators often balance farm and off-farm employment and investment decisions.

In describing types of small farm operations, classification needs to include not only the size of the farm in terms of sales but also the basic structure of the operation. How the farm is organized can affect the efficiency and competitiveness of the farm, the well-being of farm households, the design and impact of public policies, and the nature of rural areas.

In an effort to further explain the factors that affect successful small-scale farming, researchers have identified factors that have underpinnings in 1) small-farm educational programming; 2) small-scale agricultural enterprises and production practices; 3) alternative marketing; and 4) risk management. Furthermore, marketing, value-added processes, enterprises that generate income in several ways (e.g., tourism plus direct sales etc.) as well as many of the “sustainable community” or “smart growth” issues address economic viability directly (Perry, J. & J. Johnson, 1999). Specialty crops can be economically viable, particularly for smaller producers. For specialty crops, profitability is based on: 1) management of ecological capital and efficient use of on-farm natural resources, 2) diverse and specialized marketing

opportunities, and 3) price premiums available from buyers for many specialty and value-added specialty crops. Diversifying farming operations creates a greater opportunity for year-round income and can contribute to the success of the business. An example of how farmers can diversify their crop mixes includes using trees for a windbreak with marketable crops to produce small amounts of very labor-intensive-but-high-value crops such as European melons, figs, or herbs (Humphrey and Mussen, 1995). An economic analysis of the feasibility of producing biodiesel from canola seeds in North Carolina implied almost 100 percent chance of profitability (Yeboah, A., Naanwaab, C., Yeboah, O., Owens, J., Bynum, J., 2012).

Effective marketing of North Carolina specialty crops requires a correct assessment of consumer food and shopping preferences, development of successful production practices, research in production economies, and creation of new distribution channels. Finding ways for North Carolina farmers to switch to other high value crops and environmentally sensitive management practices may give them the needed income and confidence to continue to produce and diversify on small acreage and keep larger family farming enterprises viable and successful. As commodity programs are eliminated, more farmers will need to consider the potential that specialty crops offer as an economically viable alternative to tobacco and other row crops.

Even though we live in an age of technology where computers are prevalent in the larger businesses, this is not the case with small farmers. Although many small farmers use computers, manual record keeping remains a key component for these farmers (Doye, D., Jolly, R., Hornbaker, R., Cross, T., King, R., Lazarus, W., and Yeboah, A., 2000). Muhammad, S., Tegegne, F. Ekanem, E. (2004) found that computer technology does not play a vital role in small farm operations.

Key to the continuation of small farms is the ability to effectively market and operationalize factors and maintain a manageable debt to income ratio. Each farm represents an individual business enterprise that has to deal with its own unique set of these factors. The success of a small farm is likely to be based on having characteristics that enable the farm to overcome bottom line changes in market demand, operating costs and to manage risk.

According to North Carolina A&T State University's Cooperative Extension Program, small farms are alive and well across the United States and across North Carolina (North Carolina A&T State University, 1998 – 2002). Most of the farms in the United States and the vast majority of the farms in North Carolina are small farms. Successful small-scale farmers know what success means to them, however, success means different things to different people. While income from the farm is important, it usually is not the only goal of the small-scale farmer. Protecting the environment, being active in the community, a rural lifestyle, and investments for future family expenses, all can be important goals. Although, all small-scale operators face challenges, they can all be successful (North Carolina A&T State University, 1998 – 2002).

### **C) Methods**

One of the research instruments was distributed to a sampling frame that included small farmers identified as successful as well as small farmers not identified as being successful. This enabled testing of the predictive value of the “success” domains and their constituent variables/factors for differentiating “successful” and “less successful” small farmers. This sample included minorities and represented small farmers considered by County Extension agents as either not successful or uncertain about their success status. This “less successful” group represented a comparison group for determining the relative value of the success characteristics variable set.

The survey instrument was designed to solicit production and financial data, as well as farm organization, use of labor, marketing strategies, attitudes, and beliefs about farming. The instrument also solicited demographic data. The instrument consisted of a mix of short answer, yes/no, and Likert scale responses. To encourage the farmers to accurately complete the financial sections, the instrument did not request names, addresses, or telephone numbers. For this research, a small farmer is identified using the USDA definition as a farmer with total gross income less than \$250,000 for last calendar year.

A second questionnaire was distributed to a sampling frame of small farmers who were members of a cooperative farming to gauge their perception of biofuels as an alternative enterprise and the willingness to grow canola. The research instrument also solicited demographic data.

#### **D) Results**

Results of the analysis indicate that recurring indicators among the successful farmers were the “love of farming,” “manageable debt” and “workshop participation.” Other strong indicators of successful farmers included a combination of marketing strategies and a diverse mix of enterprises and specialty crops.

Additional enumerated indicators of success included: 1) the existence of clearly defined goals; 2) years of farming experience of the farm operator, 3) existence of specialty crops; 4) diversification of farming operations; 5) existence of financial management tools; 6) access to educational programs; and 7) existence of cost management.

Outcomes of this project yielded possible ways to further enhance the success of small farms in North Carolina. Based on case study and questionnaire results, income was not found to be as important as believed and the overall, “love of farming” seemed to be the driving force behind the farmer’s view of success and not profit (Table 2). The questionnaire showed differences in a lot of areas, for example, successful case study participants had little to no debt and the questionnaire participants stated that they did have debt. However, both groups agreed that their success was not measured by whether or not they made a profit.

Seventy-seven percent of the surveyed farmers were male and 23 percent were female (n=28). Forty percent of the participating farmers were Caucasian, 45 percent were African American, and 15 percent were Native American. Forty-one percent of these farmers had a high school education, 25 percent had “some college,” 12.5 percent had an “associate degree,” and 16.7 percent had a “bachelor degree.”

More than 93 percent of the farmers either agree or strongly agree that they regularly attend farming workshops and training programs. Fifty-seven percent of the farmers list their business organization as “sole proprietorship,” while 4 percent listed “partnership.” Seven percent of the participating farmers listed their business as “corporation” and 32 of the farmers listed their business type as “other” or “unknown.” The largest percentage of farmers had been farming from 10 to 20 years.

The results of the analysis of the second questionnaire concerning biofuels indicated that 78 percent of farmers strongly agree that “biofuels are important to the state/nation” (n=38) but only 42 percent strongly agree that they are “aware which crops can produce biofuels.” Forty-seven percent of farmers strongly agree that they “would adopt another enterprise if it were similar to enterprises currently in operation” and 52 percent of farmers strongly agree that “if start up cost were minimal I would be willing to add another enterprise/crop.” Sixty-three percent of farmers strongly agree that they “would be willing to adopt another enterprise/crop if financial aspects of the venture were presented at the onset of the project” while 68 strongly agree that they “would be willing to adopt another enterprise/crop if proper training were available.”

## **E) Conclusions**

Each farm represents an individual business enterprise that has to deal with its own unique set of factors. The success of a small farm is likely to be based on having characteristics that enable the farm to overcome changes in market demand and operating costs as well as to manage risk. Overall results showed that most farmers farm because they love it, the farm has been in their family for more than one generation and they plan to keep the farm in the family. Unlike the case study findings, most of the farmers surveyed do use computers to assist them with their record keeping and finances. The small farm may represent an individual business enterprise but in reality represents a family business whose success is often measured in qualitative indicators rather than business quantifiers.

## **F) References**

- Environmental Systems Research Institute (ESRI). 2002 US Census of Agriculture, 2003.
- Doye, D., Jolly, R., Hornbaker, R., Cross, T., King, R., Lazarus, W., and Yeboah, A. (2000). "Case Studies of Farmers' Use of Information Systems." *Review of Agricultural Economics*. Volume 22, No. 2, Pages 566-685.
- Hilmer, M.J. (2001). A comparison of alternative specifications of the college attendance equation with an extension to two-stage selectivity-correction models *Economics of Education Review*, 20, 260-278.
- Humphrey, S. & E. Mussen (1995). In. S. Humphrey, E. Mussen, C. Myers, R.E. Voss, and C. Wyman (Eds.). *Small Farm Handbook*: (pp 7-8), University of California. Division of Agriculture and Natural Resources Publication SFP001, Oakland, CA.
- Mayerfeld, Diane Bell, "A Matter of Scale: Small Farms in the North Central Region," University of Wisconsin-Madison Center for Integrated Agricultural Systems, February, 2004.
- Mulholland, M.E. (1993). CIPP Evaluation Model Monitoring and Evaluating Agricultural Research, A Sourcebook. CAB International 53-57.
- Perry, J. & J. Johnson. "What Makes a Small Farm Successful?" *Agricultural Outlook*, Economic Research Service/USDA, November, 1999. Pages 7 – 10.
- Muhammad, S., Tegegne, F. Ekanem, E., (2004). Factors Contributing to Success of Small Farm Operators in Tennessee. *Journal of Extension*. Volume 42 Number 4. August 2004.
- National Commission on Small Farms. A Time to Act. A Report of the USDA Commission on Small Farms USDA, 1998.
- North Carolina A&T State University (1998 – 2002). *Successful Small Farming*. Available at: <http://www.ag.ncat.edu/successfulsmallfarming/Default.htm>
- North Carolina Department of Agriculture and Consumer Sciences. 2005 North Carolina Agricultural Statistics, 2005.
- Peterson, W.L. (1980). The farm size issue: a new perspective. Staff paper P. University of Minnesota. Dept. of Agricultural and Applied Economics. February, 1980. (Pages 80-86).
- St. John, E.P., Kline, K.A., & Asker, E.H. (2001), "The call for public accountability: Rethinking the linkages to student outcomes." In D.E. Heller (Ed.), *The states and public higher education policy: Affordability, access, and accountability*. (pp.219-242). Baltimore, Maryland: The John Hopkins University Press.

United States Department of Agriculture National Agricultural Statistics Service. 2009. "2007 Census of Agricultural." AC-07-51. US Government Printing Office. Washington DC.

Yeboah, A., Naanwaab, C., Yeboah, O., Owens, J., Bynum, J., "Economic Feasibility of Sustainable High Oilseed-Based Biofuel Production: The Case for Biodiesel in North Carolina." Presented at the Southern Agricultural Economics Association Meeting on February 4-7, 2012, in Birmingham, AL.



## **Session 1 J**

**Track/Session: Research and Extension Programs/Issues and Opportunities**

### ***Issues and Opportunities Surrounding Small Farm Transition and Succession***

**Mary Ahearn, Jennifer Ifft, & Sarah A. Low**

**USDA/ERS**

**Washington, DC 20250**

**Dawn Thilmany McFadden & Martha Sullins**

**Colorado State University**

**Fort Collins, CO 80523**

The views expressed are those of the authors and should not be attributed to USDA, Economic Research Service, or Colorado State University.

### **Session Overview**

Planning for transitions, and succession in particular, has long been challenging, especially for small farms and ranches. Successful planning, however, can be a great opportunity to create a multi-generational farming operation or to aid beginning farmers in the community, and may result in the adoption of new entrepreneurial production and marketing practices. This session consisted of four short presentations. Mary Ahearn gave an overview of policies and issues related to small farms and transition. Jennifer Ifft used a national land use survey to detail the geography and demographics of small farms, land use and affordability, and how farm size and specialization differ regionally. The next generation of small farmers and ranchers may be more concerned with quality-of-life issues, so Sarah Low addressed the resilience of the community, along with how rural community wealth can influence entrepreneurship within the farm household. Dawn Thilmany McFadden and Martha Sullins shared examples of successful small and beginning farm transition programs and best practices that can enable beginning farmers and facilitate estate planning.

## **Small Farms and Transition in U.S. Agriculture, by Mary Clare Ahearn**

Family farms are defined as those farming operations where the majority of farm assets are owned by the operator or by his or her relatives. This population accounted for 98 percent of all U.S. farms and 88 percent of U.S. production in 2010. More than half (56 percent in 2010) of family farms provide all of the management, land, and labor on their farms and ranches. A common definition of a small farm is one that has gross sales of \$250,000 or less. About 90 percent of the 2.2 million farms are small farms. On average, nonfamily farms are larger than family farms, but 77 percent are considered to be small farms. About one-quarter of all U.S. small farms are in the Southeast region. The Southeast and Southwestern regions, in particular, have very small farms—approximately 70 percent of the farms in these regions gross under \$10,000 in sales. Small farms rely on off-farm income sources for their cash income since the majority of small farms lose money farming in a typical year. Farm households can receive a variety of other returns from their farms, such as a farm dwelling. For more information see: [http://www.usda.gov/oce/forum/2012\\_Speeches/Ahearn.pdf](http://www.usda.gov/oce/forum/2012_Speeches/Ahearn.pdf).

Like other businesses, many farm families start their farm business at a small scale. This is especially relevant to farming, given the high price of farm land and capital. Since at least the 1992 Farm Act, policy makers have recognized the challenges of getting started in farming by offering special terms on loan programs for beginning farmers. With the 2002 farm legislation, support was provided through loans and preferential conservation payments to beginning farmers and ranchers. In the 2008 Farm Bill, both of those initiatives were expanded and the law established grants for training programs directed at beginning farmers and ranchers. In all, 7 of the 15 titles in the 2008 legislation targeted beginning farmers and ranchers. In October 2011, the Beginning Farmer and Rancher Opportunity Act of 2011 (H.R.3236, S.1850) was introduced into the House and Senate on a bipartisan basis and seeks to build on and expand Federal government support for beginning farmers. For more information on beginning farmers and ranchers see:

<http://www.choicesmagazine.org/choices-magazine/theme-articles/innovations-to-support-beginning-farmers-and-ranchers/theme-overview-innovations-to-support-beginning-farmers-and-ranchers>.

The challenge of getting started in farming is not unrelated to the transition out of farming and ranching for retiring and senior farmers, given the relatively fixed supply of farmland. More than 30 percent of principal farm operators are age 65 or older. The average age of operators in 2010 was 58 years. More than 20 percent of farm operators report they are retired from farming. Senior farmers adjust to farming in a variety of ways, such as operating their farms at a smaller scale or participating in the Conservation Reserve Program. For more information on the age distribution of farmers and ranchers see: <http://www.ers.usda.gov/topics/farm-economy/farm-household-well-being/labor-allocations-age.aspx>.

## **Land Use, Land Value and the Effect of Urban Influence, by Jenny Ifft**

As small farms consider transition, transfer of farmland is a major challenge. Farmland is forecast to make up 86 percent of farm assets in 2012, according to the most recent USDA Economic Research Service (ERS) forecasts. Understanding current trends in land use, land values, and urban influence is critical for managing transition, including farmland transfer or acquisition. Recent ERS research has

considered these topics. Farmland values, supported by increasing farm incomes and low interest rates, have increased significantly across several regions of the United States over the last 5 years. Urban influence can also drive up farmland values. This appreciation of farmland values has led to outside (non-farmer) investors being more interested in farmland investment.

Because farm real estate represents much of the value of U.S. farm sector assets, large swings in farmland values can affect the financial well-being of agricultural producers. Several factors, including macroeconomic (interest rates, prices of alternative investments) and parcel-specific (soil quality, government payments, proximity to urban areas) factors, affect farmland values. In the last few years, U.S. farmland values have been supported by strong farm earnings, which have helped the farm sector in many regions to withstand the residential housing downturn. Historically low interest rates are likely a significant contributor to farming's current ability to support higher land values. About 40 percent of U.S. farmland has been rented over the last 25 years. Non-operators (landowners who do not themselves farm) owned 29 percent of land in farms in 2007, though that proportion has declined since 1992. For more information see: <http://www.ers.usda.gov/publications/eib-economic-information-bulletin/eib92.aspx>.

Urban proximity is strongly related to higher farmland values, but this influence has exhibited little variation nationally over the preceding decade. The difference between median values for rural and urban-influenced acreage remained relatively consistent both ahead of the housing price bubble and after its burst. Therefore, if recent strong commodity prices and farm earnings continue in the agricultural sector, it is unlikely that changes in U.S. farmland values in the near future will be a direct result of growing urban influence. The distribution of commodity production and differential housing market outcomes, however, will contribute to varied outcomes across major metropolitan areas. For more information see:

[http://www.chicagofed.org/digital\\_assets/others/events/2011/agriculture\\_conference/Ifft.pdf](http://www.chicagofed.org/digital_assets/others/events/2011/agriculture_conference/Ifft.pdf).

There is a growing notion that a large volume of farmland purchases are being made by individuals and institutions outside of the traditional agricultural sector. Over the last 15 years, farmland has offered returns higher than the S&P 500, and farmland did not experience the price bust residential housing did; however, farmland price appreciation has varied by region. For more information see: <http://giannini.ucop.edu/are-update/15/1/why-are-outside-investors/>.

### **Rural Communities, Entrepreneurship, and Small Farms by Sarah Low**

Small farm transition and succession can be positively affected by being located close to a vibrant or dense local economy—such an economy affords a place to purchase inputs, a market for agricultural products, and off-farm job opportunities. Supplementing farm income with an off-farm job may be especially important during periods of transition, as there may be both outgoing *and* incoming producers to support. Alternatively, or additionally, farms trying to support transition or succession, eg., bringing on an additional or alternate producer may need to consider additional farm enterprises and/or new markets to supplement farm income. For example, directly marketing food may increase income but may also require additional man-hours for marketing and delivery. ERS research shows that direct marketing of local foods is a more common tool for farms located near an urban area.

Entrepreneurs can help create a strong local economy by increasing income, wealth, and sometimes, jobs. Rural Americans and small farmers have entrepreneurial roots; like many other rural inventions, the steel covered wooden moldboard plough was invented in rural America *out of necessity*. Rural residents have a long tradition of solving problems with available resources, out of necessity. Perhaps as

a result, the highest non-farm self-employment rates in the country are in rural America. Indeed, entrepreneurial culture is an important type of wealth that is present in much of rural America. Research shows that intergenerational transmission of farm businesses is an important mechanism for maintaining entrepreneurial culture in a community and that entrepreneurial culture persists over time, even in the face of adversity.

ERS has recently released several reports that may be of interest to small farms facing transition, particularly those interested in supplementing farm income with entrepreneurial production or marketing practices. The reports may also be relevant to leadership of communities with a strong small farm presence, and communities interested in maintaining their small farm economy. One report discusses the role of wealth creation in rural economic development. Entrepreneurial culture, a vibrant main street economy, and access to natural amenities are all types of rural wealth that may support farm transition and succession by making a community a place to which people want to migrate or stay. For more information on rural wealth see: <http://www.ers.usda.gov/publications/err-economic-research-report/err131.aspx> .

A recent ERS report covers operator involvement in economic development-related farm activities including organic farming, value-added agriculture, direct marketing, agritourism, and energy production. While relatively few farms participate in the above activities, small farms were most likely to. The authors find that proximity to urban areas was important for direct marketing but not for agritourism, energy production, etc. For more information from this report see: <http://www.ers.usda.gov/publications/err-economic-research-report/err134.aspx> .

A 2011 ERS report focused specifically on direct marketing. Small farms accounted for 95 percent of local food farms and, on average, the majority of total sales from these farms came from local food sales. This suggests local food sales are an important part of farm income for many participating farms. For farms with local food sales, larger farms were more likely to sell food directly to grocers or restaurants, while small farms were most likely to participate in direct marketing channels such as farmers' markets and roadside stands. For more information from this report see: <http://www.ers.usda.gov/publications/err-economic-research-report/err128.aspx> .

### **The Farm Transition Continuum: Understanding Business Support Systems that Sustain Small-Scale Agriculture, by Dawn Thilmany McFadden and Martha Sullins**

Planning for transitions has long been challenging, particularly for small farms and ranches. Transition is not just a point-in-time issue; rather it is a series of events that should be facilitated to ensure that they are well-executed and include all necessary parties. Traditional models of intergenerational land transfers have focused on technical assistance (such as organizational and tax planning strategies), while early programs focused on tax management and organizational choices that primarily allowed for family-based transitions.

Creating and sustaining financially viable agricultural operations in the face of transition is a complex issue due to diversity of agricultural operations (both in terms of production systems and product diversification); proximity to urban areas (urban influence on markets and land values); and availability of markets. Providing technical assistance and case studies of operations that are successful is a challenge, especially for those working with emerging models where less traditional models of estate

planning may not be appropriate. Over the last decade, nonprofits, universities and the public sector have begun to play a greater role in creating transition mechanisms, as have land protection organizations that have created their own working lands programs. In addition, there are emerging policies and programs designed to increase the opportunities for land transfers to beginning farmers and ranchers.

Successful transition planning, however, can be a great opportunity to create a multi-generational farming operation or to aid beginning farmers in the community. In particular, there is a new interest in using transitions as an opportunity to encourage adoption of new entrepreneurial production and marketing practices. New program areas include investigating whether farming is the appropriate business choice; in-the-field training; programs that provide access to land (farm incubator and internship programs); Land Link programs; and educational programs that provide ongoing financial and technical assistance.

Visit Colorado State University's Department of Agricultural and Resource Economics, (<http://dare.colostate.edu/pubs/extension.aspx>), for a fact sheet that provides an overview of organizations and links to assist you in learning more. The fact sheet focuses on successful small and beginning farm transition programs (land matching networks, incubation programs, access to public lands for beginning farmers), as well as best practices to assist beginning farmers and provide examples of successful strategies to facilitate estate planning.

## **Session 1 K**

### **Track/Session: Marketing Opportunities/Farmers Markets**

#### **Values for the Engagement in CSAs and Farmers' Markets**

*James R. Farmer, Earlham College; Charles Chancellor, Indian University; Jennifer Meta-Robinson, Indiana University*

Currently, the United States is experiencing a boom in the demand for direct agricultural markets providing specialty crops via local food systems. Embedded within this movement are two main venues for local specialty crop consumption, community supported agriculture (CSA) and farmers' markets (FM) (Hinrichs 2000). Farmers' markets are a historic venue for acquiring fresh- local foods from a variety of farmers/growers (Robinson and Hartenfeld 2007), while CSAs, alternatively, are a newer agricultural innovation. In practice, farmers' markets maintain a regular schedule at a specific venue and the general public is encouraged to visit and shop. In contrast, CSAs are operated by farmers who sell shares to community members, and the shareholders receive the farms' produce at predetermined intervals.

Participation by consumers in these two venues offers a host of benefits for the farmers, for the local

communities, and to the participants themselves (Norgerg-Hodge *et al.* 2002; Seyfang, 2006; Sanders, 2009). Consequently, understanding consumers' values that support engagement with these venues is paramount for providers, organizers, and policymakers who seek to enhance and extend both farm sales, as well as the indirect and direct benefits that FMs and CSAs provide. Current research suggests that individuals commonly engage in these two venues out of concern for the environment, support for local farmers, access to quality food, convenience, support for the local economy, desire to eat seasonally, and access to information about growing practices (Cone and Myhre, 2000; Hinrichs, 2000; DeLind 2002; Conner 2004; Cox *et al.* 2008; and Authors 2011). However, few if any studies exist which compare the engagement values that drive participation in farmers' markets in comparison with CSAs. Accordingly, the purpose of this study was to explore the values of those engaging in FM, those using CSAs in attempt to elucidate the most critical values for participation.

## **Methods**

This study included two primary phases in order to explore and assess values for engaging in these primary local food system venues throughout Indiana. This report focuses on the results of Phases 2, which included a four-page questionnaire completed by farmers' market and CSA participants.

Based on the results of Phase 1 (in depth telephone interviews), as well as the current literature on local food participation, questionnaires were developed and used to solicit data in Phase 2 among CSA and FM participants. Farmers' market data was collected by an individual researcher attending a farmers' market and recruiting participants from those who were in attendance at the market. 12 markets were randomly selected from the Indiana State Department of Agriculture's Guide (2009) to specialty crop producers and then markets were contacted in order to request permission for data collection. Individuals had the option of filling out the questionnaire on site or taking it home and returning it in a self-addressed, pre-stamped return envelope. Seventeen CSAs were selected based on lists compiled by the researchers from Internet websites promoting CSAs and local foods. A random selection was drawn and CSAs were contacted and invited to participate. CSA data was collected by mailing 17 CSA operators a package of pre-stamped/return addressed envelopes that contained an explanation letter and a questionnaire. CSA operators distributed the questionnaire to their subscribers and the individuals completed the questionnaires and returned them in the pre-addressed / stamped return envelopes provided. Microsoft Excel was used for data management and SPSS 20.0 for data analysis. The data analyses performed include descriptive statistics that provide mean scores and proportions, paired-samples t-tests, and factor analysis that allows for the explanation of variability in individuals' food values. Phase 2 transpired between May and August of 2010.

## **Results**

Phase 2 of the study had 595 individuals participate, with an overall response rate (rr) of 40.86%. Of them, 321 were farmers' market participants (51.7% rr), 274 were CSA participants (32.8% rr).

### Community Supported Agriculture Demographics

The average age among CSA participants was 44.9 years of age, with the majority of participants being female (82.1%). The average household size was 2.77, with 56.5% not having children. The majority of CSA participants live in the suburbs (54.7%), with 28.5% living in urban areas and 15% living in rural areas. Of CSA participants, 85.6% had a bachelor's degree, with 55.5% of those having a graduate degree. Only 0.4% of CSA participants noted a high school degree as their highest level of education. Among CSA participants, 75.7% were married, with 12% single, 11.3% having a partner, and 0.7% widowed. The vast majority were Caucasian (95.3%), with minimal representations from other ethnic

groups. In considering household income levels for CSA participants, 48.8% were at or above \$90,000, with 13.6% ranging from \$75,000-89,999, 9.7% ranging from \$60,000-74,499, 8.9% ranging from \$45,000-59,999, 10.1% ranging from \$30,000-44,999, and 7.4% ranging from \$0-29,999.

### Farmers' Market Demographics

The average age among FM participants was 50.1 years of age, with the majority of participants being female (66%). The average household size was 2.46, with 71.7% not having children. The majority of FM participants live in the suburbs (44.2%), with 33% living in urban areas and 18.4% living in rural areas. 62.2% of FM participants had a bachelor's degree, with 37.3% of those having a graduate degree. Of FM participants, 2.8% noted a high school education as their highest level of education. Among FM participants, 67.3% were married, with 24.3% single, 5.9% having a partner, and 2.6% widowed. The majority were Caucasian (90.6%), with minimal representation from other ethnic groups. In considering household income levels for FM participants, 26.4% were at or above \$90,000, with 10.2% ranging from \$75,000-89,999, 14.4% ranging from \$60,000-74,499, 14.4% ranging from \$45,000-59,999, 14.8% ranging from \$30,000-44,999, and 19.7% ranging from \$0-29,999.

### Food Values

<b>Category</b>	<b>Prompt from Questionnaire</b>	<b>CSA Mean Scores (n=274)</b>	<b>FM Mean Scores (n=321)</b>
Environment	I believe consuming food produced locally is better for the environment.	4.59	4.40
Nutrition	The nutritional value of a food is an important part of my purchasing decisions.	4.51	4.37
Local Farmers	I give preference to food purchase decisions that support local farmers.	4.42	4.34
Fewer Chemicals	I give preference to foods that are grown with few chemical applications.	4.40	4.22
Local Economy	I give preference to food purchase decisions that support the local economy.	4.34	4.36
Fresh Food	I give preference to foods that were picked just a few days before my purchase.	4.33	4.31
Hormone Free	I give preference to animal products that are free from growth hormones.	4.30	4.10
Organic	Purchasing organically grown food is very important to me.	4.24	4.02

Whole Foods	I generally purchase whole foods, rather than processed foods.	4.23	3.90
Humane	I give preference to animal products that have been derived in a humane manner.	4.15	4.03
Seasonal	I give preference to eating foods that are in season, for example, tomatoes in July-October.	4.10	4.24
Local- 100 miles	I give preference to purchasing foods that come from within 100 miles of my location.	4.06	3.99
Costs of Food	The expense of fresh local produce deters me from purchasing it as often as I would like.	2.76	2.93

In all, 13 food values were tested as variables that motivate individuals to purchase from farmers' markets and to join CSAs. Among them, consuming local foods because it is better for the environment ranked first among farmers' market and CSA participants. Table 1 highlights all 13 food values and the mean score for each based on a Likert-style scale of 1-5. Table 1 also shows the results of an independent samples t-test that compared the mean score for each food value variable tested and between the three groups. The 3<sup>rd</sup> and 4<sup>th</sup> columns highlight those values that were significantly different between two groups at the .05 level. This level of significance infers that a statistical difference exists beyond random chance, when comparing the results from two groups, and suggests that the value scores between these two groups are statistically different as a whole.

Based on a Likert-style scale: 1= strongly disagree; 2= disagree, 3= neutral, 4=agree, 5= strongly agree  
*Italics* indicate a significant (.05 level) difference between the two groups.

A Principal Component Analysis (PCA) was also completed in order to determine the amount of variability that the 13 food value prompts explained in the decision to purchase local foods/specialty crops and to comprehend how variables might group together. Kaiser-Meyer-Olkin and Bartlett's tests were conducted simultaneously with the principal component analysis (PCA) and indicated that data for each category were sufficiently correlated for the analysis to be useful in explaining the phenomenon. We conducted PCA on values from the 13 categories. We used Bartlett's test to confirm the significance of the first grouping and the broken-stick rule to determine how many additional components to interpret (Legendre and Legendre 1998; Jackson 1993). The broken-stick approach can overestimate dimensionality (Peres-Neto *et al.* 2005); we chose to err in the direction of higher dimensionality.

Concerning the CSA participants the Bartlett's test indicated that the first grouping of the PCA was significant ( $\chi^2 = 1749.99$ ,  $df = 78$ ,  $p < 0.000$ ). Two components were revealed, explaining 62.8% of the variation in the data. The component with the highest proportion of communality were supporting local farmers, supporting the local economy, eating seasonally, eating locally, environmental benefits for local



foods, freshness of foods, and nutrition of foods. We interpret this to represent supporting the local community and environment through quality food purchases. The second component includes hormone free animal products, humane treatment of animals, organic foods, and foods with few chemicals. We interpret this component to represent ethical eating.

Concerning the farmers' market participant data, the Bartlett's test indicated that the first grouping of the PCA was significant ( $\chi^2 = 1114.07$ ,  $df = 78$ ,  $p < 0.000$ ). Two components were revealed, explaining 52.38% of the variation in the data. The component with the highest proportion of communality (comprising group 1), were hormone free products, products with fewer chemicals, animal products derived in a humane way, nutritious food, whole foods, organic foods, and foods that are less harmful to the environment. We interpret this component to represent ethical environmental eating and health. The second component includes supporting local economy, supporting local farmers, eating seasonally, and eating local. We interpret this component to represent locavorism.

### **Discussion and Conclusion**

Understanding the values affecting local food participation, specifically the values of CSA and farmers' market participants, will assist local farmers in developing a stable agricultural enterprise by elucidating the factors that local food consumers care about most. Considering the food values assessed, the *environment* and *nutrition* received the highest scores among the 13 values tested among farmers' market and CSA participants.

The PCA results indicated that a number of values contributed jointly under various themes for the farmers' market and CSA participants. Farmer's market participation data highlights, foremost, ethical environmental eating and health. This finding is similar to other studies, which cite environmental values in conjunction with ethical food choices, both of which provide what is perceived to be healthier food (Cone and Myhre 2000). CSA participants had a similar front running PCA grouping that additionally highlighted the support of local farmers and economies (Hendrickson and Heffernan 2002).

One salient idea from this study is the notion that both CSA and FM participants desire to support both the local farmer and local economy; however, FM participants share a demographic that is more reflective of Indiana's general population and therefore their scores on supporting local farmers and the local economy were significantly lower than their CSA counterparts. Additionally, CSAs attract a following with a special interest in knowing and committing to support of specific individuals. Finally, our findings suggest that marketing and education campaigns that emphasize environmental, nutritional, and community values may appeal to likely prospects FM and CSA customers.

## **Session 1 L**

### **Session: Outreach to Underserved Communities: Risk Management Plans**

## **Developing Personal Risk Management Plans for Limited Resource and African American Producers in Arkansas and Mississippi**

*Laurence Crane, National Crop Insurance Services, Albert Essel, Delaware State University, Henry English, University of Arkansas and Anthony Reed, Alcorn State University, Pine Bluff*

### ***Developing Personal Risk Management Plans for Limited Resource and African American Producers in Arkansas and Mississippi***

**Dr. Laurence M. Crane Dr. Albert Essel**

**National Crop Insurance Services Delaware State University**

**Project Director Project Co-Director**

**Dr. Henry English Mr. Anthony Reed**

**University of Arkansas—Pine Bluff Alcorn State University**

#### **Project Summary**

The goal of this project was to assist Limited Resource and African American Producers of Specialty Crops and Underserved Commodities in Arkansas and Mississippi in responding to risk in the five special emphasis areas of production (crop and livestock insurance), marketing (strategies and farmers markets), financial (farm management strategies), legal (liabilities and estate planning), and human resource (labor) management. Individualized risk management responses were formulated using the business planning approach. An applied education program consisting of three sequential workshops in each state (6 total) and individualized counseling was developed and conducted via a partnership of two trainers, two state host coordinators (SHC) and twelve local educators (LE). Specific project objectives were to use a business planning approach to:

- (1) Review risk management principles, practices, and tools to familiarize producers with how they can be effectively applied in a holistic approach to their farm situation,
- (2) Assist producers in conducting an effective risk assessment of their own farm business,
- (3) Inform producers of alternative risk management strategies, including crop and livestock insurance, and delineate financial and marketing opportunities for alternative case scenarios,
- (4) Assist producers with formation and adoption of their own individualized risk response strategy, and,
- (5) Review the financial implications and legal considerations of their chosen strategy.

The primary outcome of this educational effort was for participants to develop the skills and to understand their own operations well enough to develop personalized risk management strategies for each of the five emphasis areas specified above. The extended duration and iterative nature of the program, with sequential workshops and individualized follow-up, provided participants with an opportunity to both develop and revise plans with their own data and have it professionally reviewed.

This concentrated and hands-on approach to education typically leads to long-term behavioral change and is consistent with the philosophy that behavior changes are more likely with sustained personal support.

### **Priority and Emphasis**

This activity focused on producers of specialty crops where there is no insurance coverage, and producers of underserved commodities that are covered by crop insurance but have a participation rate lower than the national average. Many of these producers have limited historical knowledge and/or personal experience with insurance programs. It is imperative that they receive the tools necessary to benefit from the use of crop insurance where available and learn how it can be used in concert with the other risk management and cost control strategies they employ.

Additionally, this project concentrated on underserved Limited Resource and African American producers in Arkansas and Mississippi. Moreover, the two State Host Coordinators and twelve local Extension Educators all have extensive experience working with Limited Resource and African American farmers.

### **Partnering**

Project partners were Dr. Laurence Crane, NCIS Vice President—Education and Communication; Dr. Albert Essel, Associate Dean for Extension, Delaware State University; Dr. Henry English, Small Farm Project Director, University of Arkansas—Pine Bluff; and Mr. Anthony Reed, Interim Assistant Extension Administrator, Alcorn State University in Mississippi. Dr. English (AR) and Mr. Reed (MS) are the Small Farm Program Coordinators in their respective states, and were selected based on their membership in and personal relationships with the target audience (Small, Limited Resource and African American farmers), and their history of delivering exceptional educational programs to these farmers and ranchers.

Dr. Albert Essel, Delaware State University, assisted in managing the project and teaching the workshops. Dr. Essel has co-authored several extension publications on all aspects of marketing and financial risk management. He has extensive educational experience in the south working with African American producers on a wide array of farm and risk management issues including business planning, financial and economic development and marketing strategies common in the region. Dr. Essel is a gifted teacher and relates well with limited resource and African American producers and ranchers due to his personal background and professional experiences at Fort Valley State University, Virginia State University, and Delaware State University. Additionally, he has been involved with outreach programs at almost all of the 1890 Land-Grant Universities.

### **Project Delivery**

The delivery of this risk management education program consisted of two major components: 1) workshops, and 2) individualized study. Three day-long (6 hours, 18 hours total) sequential workshops were conducted in each state (Arkansas, Mississippi) approximately 30 days apart. There were 52 producers (21 in Arkansas and 31 in Mississippi) who attend the three workshops. The same producers

attended all three workshops conducted in their state. Workshop activities were designed to build upon each other with specific homework (individual study) assignments to be conducted following each workshop. The three homework/ individual study assignments were designed to take approximately 20 hours each (60 hours total) to complete. The twelve local Extension Associates were responsible to follow-up on an individual basis with the producers to ensure that homework assignments were completed.

The day-long workshops (component one) were instructional with “hands-on”, participatory exercises. Participants worked through several case examples and begin applying the principles learned to their own operations. Participant progress and learning was monitored with the Personal Response System (PRS) and other written assessment techniques. PRS technology was particularly well-suited for this workshop as risk assessment and response strategies can be quite personal. Individuals who may be hesitant to speak orally can simply respond to questions anonymously by pressing numbers on a device resembling a TV remote control. A computer and receiver process the responses instantly and graph the results for all to see. The PRS was used periodically throughout the workshops to engage participants and monitor the progress of their understanding.

Each participant was expected to develop a personalized risk management action plan for each special emphasis topic (production, marketing, financial, human, legal) over a period of time following the initial workshop. This required participants to evaluate the risk situation of their operations, set goals for managing risk, interact with professionals (e.g. loan officer, crop insurance agent, estate planning advisor, etc.), and develop specific strategies to measure and manage risk. All workshop materials and supporting documents were provided in hard copy and electronically for review and downloading. The State Coordinators, working with the local educators, made contact with the participants at regular intervals to offer assistance and encourage them in their efforts. Involving local educators and other local resource people (crop insurance agents, lenders, etc.) strengthened the network of advisers that participants could tap into and obtain additional information. These resources provide a support network that enables adoption of program materials and increases the probability of long-term success.

## **Results**

The primary outcome of this educational effort was for participants to possess the skills and to understand their own operations well enough to develop personalized risk management strategies for each of the five emphasis areas (production, financial, marketing, legal, human). Participants were expected to spend at least 20 hours completing homework assignments after each workshop for a total of 60 hours expected. On the written evaluation form they reported spending an average of 22.4 hours per session for a total of 67.4 hours of personal homework. Moreover, each of the 52 participants established a goal in each of the five risk emphasis areas and delineated three specific actions they would take during the next year to reach each goal.

A secondary outcome of this project was to develop and foster a long-term working relationship between the farmer participants and the local educators (Extension Associates). Moreover, this educational approach also improves the skills of these educators. The personal interaction of these farmers with the local Extension Associates as designed in this project has the potential of creating long-lasting relationships that will be mutually beneficial.

The most important indicator of success was the strong participation by the participants who returned each time and actively participated in each of the three workshops. At the conclusion of the last

workshop several farmers commented orally and on the written evaluation form that they were grateful for the opportunity to participate, had learned more than expected, and wished the series could continue on a regular basis.

## **Participant Testimonials**

### **Farmers and Ranchers**

“This is what I learned from the risk management class. The first exercise was one of the best I had, because it helped me realize I really didn’t know what I had for assets. The lesson for that week was to go home and look at everything and do an inventory and see what assets you have. What I learned really surprised me. This was a really great class to do. I learned about risk management, and about asset and liability management. I would tell everybody—If you are into farming, you need to take this class.”

*Keith January, Sr., Fayette, Jefferson County, Mississippi*

“This workshop has been most helpful to me because I have learned the different aspects of risk management on a farm. There are great aspects of record keeping, and financial record keeping is one of the most important things in taking care of the business on the farm.”

*Sandra Bennett, Madison County, Mississippi*

“I enjoyed participating in the workshops. I learned a lot about business planning as well as risk and goal setting and asset management; basically what is being looked at by bankers and other people these days in agriculture. I’m glad I participated in the program and thankful that Alcorn State University invited me to participate and it should be very beneficial to me.”

*Louis Sanders, Mound Bayou, Bolivar County, Mississippi*

### **Educators**

”Over the years, I have been involved with many educational interventions in agricultural risk management for socially disadvantaged producers and educators who conduct programs for underserved audiences. The response that we received from these producers in Mississippi and Arkansas during this series gives me hope that for once we have hit the target. The energy, enthusiasm and desire to learn tools for managing farm risk among the participating producers was exhilarating and infectious.” *Dr. Albert Essel, Delaware State University; Project Co-Director*

“From this risk management training, the producers worked on case studies that helped them understand and better manage their farm enterprises. Some of the producers are still working on goals that they agreed to complete after the training. It has been inspiring to see them take information from the workshops and actually achieve short-term goals discussed during the training.” *Kandi Williams, UAPB & Silas H. Hunt Community Development Corporation Small Farm Program, Texarkana, Arkansas*

“This concentrated and hands-on approach to education typically leads to long-term behavioral change and is consistent with the philosophy that behavior changes are more likely with sustained personal support. This project changed the participants’ behavior in a positive way.” *Dr. Laurence Crane, National Crop Insurance Services, Project Director*

“I was quite pleased by the interest that the participants showed in the material that was presented. Several famers indicated that this was their first time being exposed to this quality of education on these topics, and they really appreciated the effort to help them learn the material.” *Dr. Henry English, University of Arkansas—Pine Bluff, project State Host Coordinator for Arkansas*

“I believe the participants in the RMA/NCIS class received a holistic approach to risk management that I feel will help to sustain, enhance and minimize their risks on their farming enterprise.” *Mr. Anthony Reed, Alcorn State University, project State Host Coordinator in Mississippi*

## **Session 1 M**

### **Track/Session: Program Planning and Implementation/Leadership Development**

#### **Partnerships and Collaborations: Keys to the Success of the Small Farmer Agricultural Leadership Institute**

*Dawn Mellion-Patin, Southern University A&M College, Baton Rouge, LA*

## **Session 1 N**

### **Track/Session: Research and Extension Priorities/Using Technology in Programming**

#### **Going Digital: Lessons learned from the “eXtension Entrepreneurs and Their Communities” Team**

*Mary Peabody, University of Vermont, Burlington, Connie Hancock, University of Nebraska, Lincoln, and Glenn Muske, North Dakota State University, Bismarck*

#### **Going Digital: Lessons learned from the “eXtension Entrepreneurs and Their Communities” Team**

Mary Peabody

**University of Vermont, Burlington, VT**

Connie Hancock

**University of Nebraska-Lincoln, Lincoln, NE**

Glenn Muske  
**North Dakota State University, Bismarck, ND**

**Session Summary**

As one of the original eXtension teams, the Entrepreneurs and Their Communities Community of Practice (ETC COP) has been involved in developing and expanding its community of users from within Extension itself as well as from existing and nascent entrepreneurs, community leaders, and agency employees who work in this area. The focus has been the provision of education content that will help in developing and building entrepreneurs and communities as part of an economic development program.

The team took a broad view of entrepreneurship and included small farm operators often involved in value-added or specialty crop/animal production. The work to date has looked at the questions of individuals in this area and the means that best provides them with the answers to the questions they have using the media they prefer and all done in a timely manner.

The result of the ETC COP to date found:

- Response to questions is most satisfactory if received in 24 hours or, at most, 48 hours.
- Webinar topics of interest vary. Archived webinars are accessed more frequently than by those attending the live event.
- Webinar participants enjoy hearing from other business owners like themselves.
- Short, supporting content is more often accessed than longer articles
- Research is not often accessed unless it also has specific tips that business owners can use.

The ETC COP connects consumers and technical assistance providers with experts who know are well-versed in using technology to help rural business owners start, develop and operate successful businesses. In the case of small-scale farmers, assistance can help them identify potential feasible ideas, examine the market, help set price points, develop a marketing campaign, and consider price points and customer service in their business operation.

The presentation introduces participants to the community of practice. Information regarding the FAQ section, Ask an Expert component, the successful webinar series, and the resources and links available will be discussed. Audience members will be encouraged to join our Community of Practice and also to encourage the small-scale farmers who are trying to develop a business operation to join and utilize all of the resources available.

**Session Handout** – See next page

## ***Entrepreneurs and Their Communities COP***

Mary Peabody – mary.peabody@uvm.edu

Connie Hancock – chancock1@unl.edu

Glenn Muske – glenn.muske@ndsu.edu

[www.extension.org/entrepreneurship](http://www.extension.org/entrepreneurship)

**Purpose:** Provide working knowledge

**How:** Using an interactive learning environment that connects knowledge from the land-grant university faculty and staff from across America to consumers looking for answers and assistance

eXtension offers:

- **Credible expertise**
- **Reliable answers based upon sound research**
- **Connections to the best minds in American universities**
- **Creative solutions to today's complex challenges**
- **Customized answers to your specific needs**
- **Trustworthy, field-tested data**
- **Dynamic, relevant and timely answers**

What you will find:

- **“Ask an expert” opportunities**
- **Frequently asked questions**
- **Yearly webinar series with an archive of past webinars**

<http://www.extension.org/pages/16074/entrepreneurs-and-their-communities-webinar-series>

- **September through June**
- **2nd Thursday of the month**
- **2 pm Eastern**
- **Articles offering a more in-depth look at various topics**
- **News articles and upcoming educational programs**
- **Links to other learning modules**
- **PLUS: Other communities with additional information**
- **Specific agricultural products**
- **Small meat processors**



- Farm energy
- Horticulture topics

Our History: Launched in 2007, the “Entrepreneurs and Their Communities” team is comprised of Extension faculty from across the nation having strong backgrounds and extensive Extension-related responsibilities in the areas of community and economic development. It is a multidisciplinary team comprised of agricultural economists, rural sociologists, community development educators, and human scientists working in tandem to produce and incorporate the best information and educational resources available on a the subject of entrepreneurship. As a result of their close working partnership with the Regional Rural Development Centers, this CoP has effectively drawn Extension educators from the four regions of the United States to be part of this exciting initiative.

Join us:

[www.extension.org/entrepreneurship](http://www.extension.org/entrepreneurship)

Or on Facebook:

<https://www.facebook.com/eXtensionentrepreneurs?ref=hl>

## **Session 2**

### **Session 2 A**

**Track/Session: Alternative and Traditional Enterprises/National Goats**

### **Session 2 B**

**Track/Session: Marketing Opportunities/Enhancing Marketing Avenues – Part I**

*Targeting Direct Marketing Consumers for Small Farm Profitability*

**Ramu Govindasamy and Isaac Vellangany**

**Department of Agricultural, Food and Resource Economics**

**Rutgers-The State University of New Jersey, New Brunswick, NJ**

Direct marketing is a technique that allows farmers to sell their products directly to their targeted consumers, rather than having their goods pass through several hands before it reaches the end users as it often has. This practice enhances farmer receiving a greater profit as their direct-to-consumer sales

revenue is less than \$50,000 per year. Products most commonly sold at direct markets include fruits, vegetables, bakery products, flowers, nursery products, eggs, and dairy products. By using direct marketing, producers can cut out the intermediaries in their operations and minimize additional expenditures on services, such as packaging, storing, transporting, and marketing the goods. There are several forms of farmer-to-consumer direct markets, including: pick-your-own operations (PYO), roadside stands, community supported agriculture (CSA) farms, community farmers' markets, and on-farm markets. PYO operations enable consumers to harvest their own produce from the farmers' fields, allowing them to choose and buy only the amount and quality of food they desire. Roadside stands are structures set up near roadways by farmers in order to sell their own seasonally grown produce. CSA farms are supported by a group of members who create a relationship with the farmer by paying a fee and investing in the farm in exchange for a weekly assortment of produce. Community farmers' markets are establishments where farmers can bring their goods to be sold to consumers alongside those of other farmers. Each of these outlets provides product heterogeneity and offer options for consumers to obtain the goods and services they desire.

Though not every direct marketing outlet type is currently recognized by the public, the idea of such establishments has been in practice for decades and is not a new practice for farmers. To help develop the industry in the past, the Farmer-to-Consumer Direct Marketing Act of 1976 was established to provide \$3 million in federal grants to initiate, promote, facilitate, develop, or coordinate methods of direct marketing from farmers to consumers. This act recognized the importance, potential, and promise of direct marketing operations in the future, especially its role in improving the agricultural economy. To prove its success, the USDA's Agricultural Marketing Service (AMS) recorded a growing number of farmers' markets in the United States. In recent years. It found an increase from 4,385 farmers' markets nationwide in August 2006 to 4,685 in August 2008 (AMS, 2008) In 2007, it invested nearly \$1.5 million in 88 projects specifically to develop farm business strategies, support innovative research projects, improve farmers' markets and assist in agri-tourism projects (NYSDAM, 2007). With the help of grants and loans to farm enterprises, agribusinesses have clearly been successful over time, and have thus, also prospered from individuals who visit the businesses nationwide.

An internet survey was conducted between June 22 and 29, 2010, for 15 minutes to gather information from consumers who reported participating in direct marketing and agritourism activities in the United States Mid-Atlantic region. Nearly 1,134 residents from Delaware (133), New Jersey (424), and Pennsylvania (577) completed the survey. Participants were selected at random from a panel managed by a survey research company (Sampling International, LLC, Shelton, CT). Potential subjects were screened based on the following criteria: 1) age 18 and older; 2) primary food shopper for the household; and 3) had previously attended agritourism and direct marketing events or activities.

An important piece of information needed in order to properly apply any findings from the study is to know what direct market outlets are visited most. Participants were asked about all of the types of direct market outlets types they typically patronize. The survey included four of the outlet types described in the introduction: Pick-your-own (PYO) farms, community farmers' markets, community supported agriculture (CSA) farms, and on-farm markets. Distribution of respondents per outlet type and per state is detailed in Table 1.



Table 1. Distribution of Respondents by Marketing Outlets

Direct Market Outlets	State						TOTAL	
	Delaware		New Jersey		Pennsylvania			
	N	%	N	%	N	%	N	%
Pick-your-own farm	71	53.38%	225	53.07%	259	44.89%	555	48.94%
Community Farmers' Market	110	82.71%	340	80.19%	491	85.10%	941	82.98%
Community Supported Agriculture (CSA) farm	9	6.77%	49	11.56%	51	8.84%	109	9.61%
On-Farm Market	77	57.89%	241	56.84%	309	53.55%	627	55.29%
All	133	100.00%	424	100.00%	577	100.00%	1134	100.00%

Note: N = Frequency, % = Percent, since respondents selected more than one choice, total percentages do not add to 100%

To demonstrate how much consumers value direct marketing outlets and what they have to offer, respondents were asked several questions concerning visitations, expenditures, and accessibility to determine if there is a correlation between the patronization of one type of farm-direct marketing outlets over other types. Our findings show that community farmers’ markets get the most visits per year in each state, approximately seven visits on average, with slightly more in Delaware and slightly less in New Jersey than Pennsylvania. However, respondents said that on average they only visit pick-your-own farms and on-farm markets about two and four times a year, respectively. Community supported agriculture farms are visited the least out of all the outlets, with a mere less than one visit per year in each state.

Figure 1 below shows the combined per visit average market outlet expenditure as well as averages

segmented by state. As the results illustrate, consumers spent the most at community farmers’ markets, with an overall average of \$21.18 per visit, followed by on-farm markets, where the average expenditure was \$17.38. However, there was some variation based on participant’s state of residence. New Jersey residents spent approximately \$19.53 on average at on-farm market outlets, whereas Delaware residents spent \$15.95 per visit. Pertaining to PYO operations, \$13.51 was the average amount; however, there was also some dissimilarity based on state of residence. Pennsylvania residents spent \$11.79 per visit at PYO farms, while New Jersey residents spent up to \$15.45 per visit. In accordance with our previous findings, consumers spent the least on CSA farms in the three states, averaging only \$4.84 per visit.

Additional survey questions asked participants about their willingness to pay more for products from direct marketing outlets versus products purchased from other providers. First, Figure 2 shows that nearly two-thirds of the respondents said that they would be willing to pay more for products from direct marketing outlets. The distribution percentage of Delaware’s respondents was slightly higher than the other two states, showing that residents there are slightly more willing to pay than individuals residing in New Jersey and Pennsylvania. Participants, who replied ‘yes,’ that they would be willing to pay more, were asked to indicate what percentage increase they would be willing to accept.

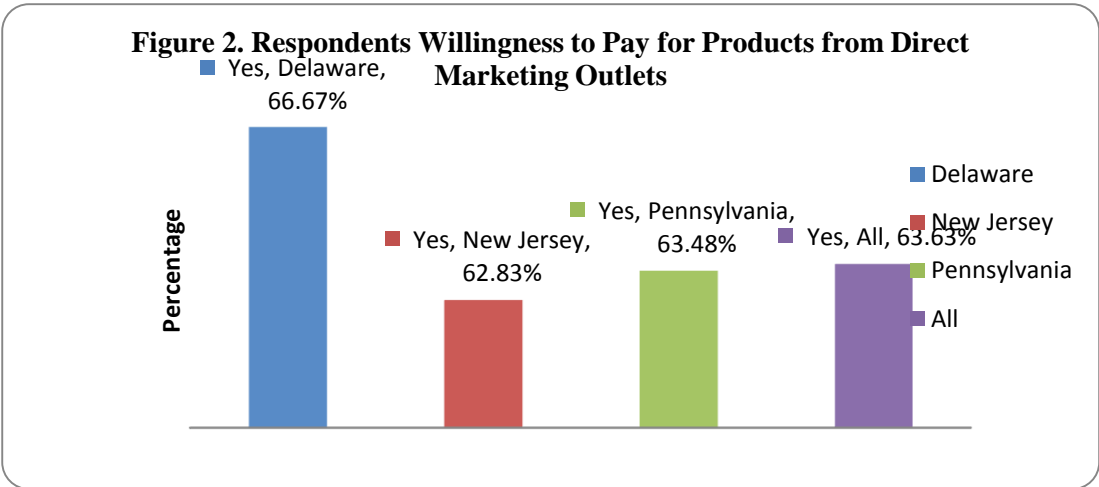

The majority (41 percent) were willing to pay at least 6-10 percent more for products from direct marketing outlets, while 28 percent were willing to pay at least an additional 1-5 percent more. Around 14 percent of consumers were willing to pay 11-15 percent more, while 9 percent would pay 16-20 percent more, and 4 percent would pay 21-25 percent more. Many consumers seemed to be satisfied with features of products offered by the businesses, such as quality, variety, and price. Patrons also made it clear that they were almost all willing to buy locally grown products from the outlets, which perhaps should become the markets’ main promotional focus. Moreover, consumers responded that between 2005 and 2010, they had begun to consume a greater amount and a wider variety of both fruits and vegetables. This seems to be very much aligned with the overall trend in health-conscious consumers to eat healthier and to consume no or little processed food products, particularly by reducing meat consumption and considering organic options. All of these factors are important because they ensure that consumers will continue to purchase products from the selected outlet types, leading to enhanced income opportunities for farmers.

## *Marketing Channels Used by Small Farmers in Tennessee*

*Tegege, F., S. Pasirayi, S. P. Singh, E. Ekanem, P. Illukpitiya, Tennessee State University, Nashville, TN*

### **Marketing Channels Used by Small Farmers in Tennessee**

**Tegege, F., S. Pasirayi, S. P. Singh, E. Ekanem, P. Illukpitiya**

**Tennessee State University, Department of Agricultural and Environmental Sciences,  
Nashville, TN**

#### **Introduction**

Small farms account for approximately 91 percent of all U.S. farms and control more than half of the land in farms. In Tennessee about 93.2 percent of the farms are small (USDA-National Agricultural Statistics Service ASS, 2007). They participate in government environmental programs such as the Conservation Reserve Program (CRP) and the Wetland Reserve Program (WRP). Challenges that small farmers have been facing in various areas over the years, including marketing, are well known (see for instance USDA-National Small Farm Commission, 1980). Their performance also affects the viability of rural communities in which they are located. The goal of this study was to analyze marketing channels used by small farmers in Tennessee and share the findings with stakeholders.

#### **Data**

Primary data were collected using a mail survey instrument administered in 2010. A total of 250 farmers were selected for the survey from the Tennessee Department of Agriculture database. Completed questionnaires were received from 92 farmers. This represents a response rate of 36.8 percent. The survey covered types of enterprises operated and their characteristics as well as those of the operators

#### **Profile of Farmers Selected for the Survey**

Farmers selected for the survey had an average of 175 acres under production. Less than 5 percent of the farmers had more than 250 acres. The majority (55 percent) of the respondents operated livestock enterprises and 45 percent produced crops (Table 1). The farmers surveyed had annual gross farm income of \$100,000 or less with 85.4 percent having less than \$40,000. The majority (71.2 percent) of the respondents were engaged in off farm work with 57.3 percent holding full time jobs. Only about less than a third (28.8 percent) of the respondents relied on farming as a sole source of income (Table 2). In terms of education, more than one quarter of the farmers had high school or equivalent education, 22.8% had some college level education, 26 percent had college degree, and 16.3 percent had graduate degree or some graduate level education. The majority of the farmers surveyed are married (Table 3).

#### **Choice of Marketing Channels**

Following are some of the findings of this study. Farmers operating both types of enterprises (crops and livestock) ranked direct sales to consumers first, and contract sales last. The farmers favored direct marketing because the one-to-one relationship brought them and consumers together, and reduced their transaction cost. Farmers with more formal education tended to avoid middlemen compared to those with less education. Farmers operating animal enterprises tended to use channels with middlemen compared to crop producers. Those who had off-farm jobs used marketing channels that involved

middle men. Farmers that were willing to take risk preferred direct marketing channel compared to those that are risk averse reflecting their readiness to accept loss associated with reduced price and income if products are for instance sold at spot price.

### Conclusion

This study found that small farmers predominantly use direct marketing channels compared to other alternatives [Such as?]. Given their limited access to national and international markets, small farmers may need to focus on entry into the local and regional markets. Policy makers can pursue targeted strategies to help small farmers by providing relevant and timely information in production and marketing. An expanded quantitative study can also be conducted with better response rate from farmers.

Table 1: Type of Enterprises Operated

Farm Size	Type of Enterprise (%)		Total
	Crop	Livestock	
Below 50 acres	2.1	7.6	9.7
50 - 99	6.5	7.6	14.1
100 - 149	13	9.7	22.7
150 - 199	13	19.5	32.5
200 - 249	8.6	7.6	16.2
Above 250	1.8	3.2	4.8
<b>Total</b>	<b>45</b>	<b>55</b>	<b>100</b>

Table 2: Distribution of Operators by Gross Annual Farm Income

Gross Annual Income from Farm Enterprises	Full - Time Farm (%)	Off - Farm Employment (%)		Total
		Part - time	Full - time	
Less than \$10000	2.1	0	3.2	5.3
\$10,000 - \$19,999	0	3.2	5.4	8.6
\$20,000 - \$29,999	5.4	4.3	17.3	27
\$30,000 - \$39,999	14.1	5.4	25	44.5
\$40000 \$49999	1	1	4.3	6.3
\$50,000 - \$100,000	6.2	0	2.1	8.3
Total	28.8	13.9	57.3	100

Table 3 : Educational Level Gender, and Marital status of Farmers

Level of Education	Marital Status	Gender		Total
		Male	Female	
Attended Grade School	Married	1		1
Some High School	Married	2		2
	Widowed	2		2
High School Diploma or Equivalent	Married	26		26
	Divorced	1		1
Some College or Technical School but no degree	Married	16	3	19
	Divorced	2	0	2
College Degree	Married	20	1	21
	Single	1	0	1
	Divorced	1	0	1
	Widowed	1	0	1
Some Graduate School or Graduate Degree	Married	9	3	12
	Single	3	0	3
Total		85	7	92

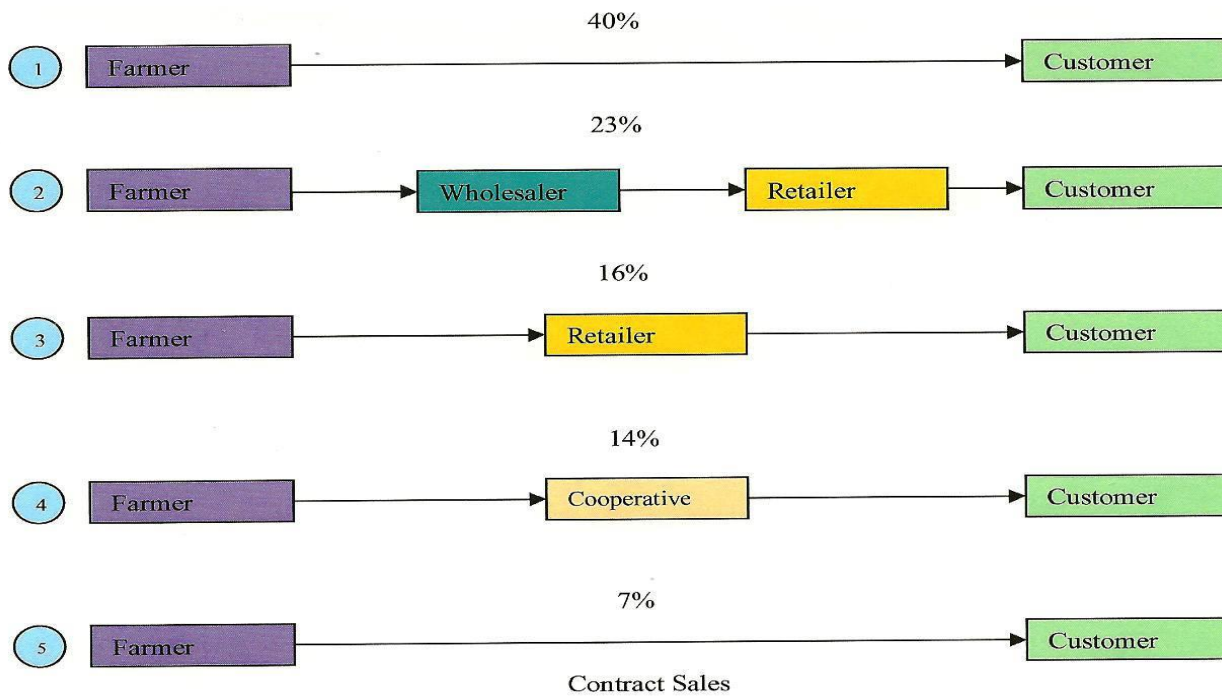

Figure 1. Marketing Channels Used by Small Farmers

References

USDA –NASS. (2007). The 2007 Census of Agriculture, NASS, Washington DC.  
 USDA. (1980). National Commission on Small Farms, USDA, Washington, DC.

## Session 2 C

**Track/Session: Outreach to Underserved Communities/**

**General Education: How to's Part II**

### **Extension Programs Targeted to Assist Sustainable Farming and Diversified Agriculture Operations**

*Gary Lesoing, Jessica Jones, Lindsay Chichester, Vaughn Hammond, Elizabeth Sarno, John Wilson, University of Nebraska, Lincoln, and William Powers, Nebraska Sustainable Agriculture Society*



***Extension Programs Targeted to Assist Sustainable Farming and Diversified Agriculture Operations***

**Gary Lesoing, Jessica Jones, Lindsay Chichester, Vaughn Hammond, Elizabeth Sarno, John Wilson**

**University of Nebraska-Lincoln**

**Lincoln, NE 68508**

**William Powers**

**Nebraska Sustainable Agriculture Society**

**Ceresco, NE 68017**

In the past several years, the University of Nebraska-Lincoln, the Nebraska Sustainable Agriculture Research and Education (SARE) Program and the Nebraska Sustainable Agriculture Society have partnered together on a comprehensive program to assist people in learning about sustainable farming practices and also train beginning



farmers. Our "Farm Beginnings" program includes 10 sessions on goal setting, farm planning, marketing, financial management, and developing a business plan. We also focus on sustainable farming practices and diversified farming opportunities. Successful sustainable farmers give presentations about their farming operations and focus on the previously mentioned topics. In the summer, we also tour several of these farms to see firsthand what they are doing on their farms. Several of these farmers serve as mentors for the beginning farmers and also help them in developing a farmer network. The past 3 years, 16 farmers completed the program and are farming on a limited scale. This program costs \$500 and has included a registration to the Rural Advantage/Healthy Farms Conference. Participants also have the opportunity to receive scholarships that help with the cost of the program. Many participants believe that the greatest benefits of the program are the development of the farmer network and resources they can use to improve their farms.

The Nebraska SARE Professional Development Program main focus is to provide education to Ag Educators who will in turn educate farmers about sustainable agriculture. The SARE Ag Educator tours

have provided some excellent education on sustainable agricultural enterprises, including the local food systems in Nebraska. Tours the past 3 years in Nebraska focused on:

- Production & Marketing of Local Food
- Community Supported Agriculture (CSAs)
- Community Crop
- Farmers Markets
- Food Coops
- Restaurants, grocery stores and institutions that source local foods
- Sustainable Vegetable, Crop and Livestock Production

Eighty-four Ag educators participated in these tours the past 3 years (2010 – 2012). On a scale of 1-5, 90 percent of Ag educators gained a moderate to significant increase (>3) in knowledge gained in local food systems, growing fruits and vegetables, and in growing and marketing naturally-raised meat.

In our Southeast Nebraska Diversified Ag Tour, 35 farmers and ag educators participated the past 2 years. Seventy-five percent of tour participants saw new ideas they could use on their farms or in their business enterprises and over 70 percent thought they would improve their farm's sustainability, expand their markets for locally grown food, and incorporate diversified ag opportunities into their farming operations.

The Rural Advantage/Healthy Farms Conference annually attracts 175 people and provides an opportunity for farmers and ag educators to learn about sustainable agriculture. Topics addressed at this conference include: organic crop production, cover crops, organic weed control, high tunnel vegetable production, organic vegetable production, grass-fed beef, CSAs, agri-tourism, mob grazing, holistic management, and beekeeping. In 2011, 53 percent of participants reported an increase in alternative agriculture practices and 79 percent reported that attending the conference would assist them in improving their production practices on their farm.

The final component of our Sustainable Agriculture Program has been our Sustainable Ag Webinar Series. Over 4,400 people have viewed over 20 webinars on a number of the previously listed topics on sustainable agriculture. These webinars are recorded so they are available 24/7 for anyone who has Internet access.



**Outrunning the Horizon: How What You Do Today Can Shape Your Farm's Future**

*Jeffrey Jandura, Land Loss Prevention Project*

## **Outrunning the Horizon: How What You Do Today Can Shape Your Farm's Future**

**Jeff Jandura, Senior Staff Attorney**

**Land Loss Prevention Project,**

**SmartGrowth Business Center, Durham, NC**

### **Overview**

In times of economic challenge, maintaining and growing a farm enterprise requires a balancing act that embraces both risk-taking and prudence. The Land Loss Prevention Project (LLPP), through its SmartGrowth Business Center, assists limited resource and socially disadvantaged farmers in North Carolina in achieving that equilibrium, providing legal consultation and outreach on business issues and agricultural entrepreneurship. In a state where approximately 85 percent of the family farms are characterized as small family farms and the average age of principal operators is 57, according to the USDA's 2007 Census of Agriculture, sustaining a farming economy must encompass risk management and treat even the smallest farm as a potentially robust and innovative business engine within the community.

LLPP is a non-profit law firm in Durham, NC, serving limited resource clients in the entire state with legal representation in issues involving land preservation and utilization. Our work includes mortgage foreclosure prevention, through both educational outreach and direct representation; landowner representation in eminent domain proceedings; heir property issues, including property partition proceedings; loan modification and payment program assistance; representation in Chapter 12 and Chapter 13 bankruptcy proceedings in attempts to preserve the assets and land of both small farmers and residential property owners; and client representation in matters involving adverse decisions from the agencies of the United States Department of Agriculture as they affect rural property owners and farm loans.

### **The Need to Create the SmartGrowth Business Center**

By the nature of its mission, the attorneys of LLPP have often been called on for assistance at the 11th hour on a crisis that has its roots in long simmering difficulties, some within and some outside of the individual client's control. SmartGrowth Business Center, a new internal resource, was created to assist farmers interested in taking a proactive approach to business.

SmartGrowth is dedicated to assisting farmers who desire to gain or expand their business expertise. Farmers, especially small and limited resource farmers, face challenges every day that can affect their livelihood and the health of their business. SmartGrowth is focused on promoting solid business practices and using the law to assist farmers in securing their investment. The work involves such diverse activities as one-on-one meetings with farmers and those thinking of entering into farming; educating farm families on issues involving business succession; land ownership and transfer; and presenting at both community events and agricultural conferences on a variety of issues such as business entity formation, mortgage assistance programs, trademarks, property tax abatement programs, estate planning, eminent domain issues, loan servicing requirements, cooperative formation, and USDA loan programs.

### **Reaching Farmers**

In order for the mission of the SmartGrowth Business Center to be successful, it is essential that as many farmers as possible be reached in a state of 48,617 square miles. In addition to having a dedicated website presence, in-person presentations are made to agriculturally-based audiences on an ongoing basis, discussing topics related to the preservation and growth of the small farm.

## **Farming as a Business**

### **Business Entity Formation**

Farming is diverse and so are the individuals involved in such an endeavor. Therefore, there is not a “one size-fits-all” form of advice that can be given as a blanket roadmap to each farmer. However, through the course of time, we have seen a replay of questions, issues and problems raised by the small and disadvantaged farmer seeking our services.

Of the 52,913 North Carolina farmers counted in the 2007 USDA census, 45,766 were listed as family or individual farmers; 4,246 were categorized as partnerships; 2,625 were listed as corporations; while 276 were classified as “other-cooperative, estate or trust, institutional, etc.” One of the services provided by the SmartGrowth Business Center is to educate the small and beginning farmer on the various forms of business entities available to them. Although the creation of a business entity is not a requirement for farming, and not always necessary, there are many instances where the use of such a legal tool can be of benefit to the small farmer. Therefore, we provide the service of discussing the necessary steps in forming and operating a corporation, limited liability company, limited liability partnership, farming cooperative or farm marketing cooperative for the purpose of farming. The attorneys of SmartGrowth also counsel their clients on the legal and practical limitations associated with each form of potential business entity. Should a qualifying farmer, after consultation and exploration of options, wish to form such an entity, the SmartGrowth Business Center can and has assisted him in the successful filing of his papers and the legal creation of his enterprise.

In some instances, a business entity can be an effective method of succession planning. This can be achieved by the use of corporate shares in the farming operation being held by family members. Carefully crafted bylaws or operating agreements can provide for equitable procedures to arrive at valuation of shares and the right of family members to have first right of purchase of any shares that existing shareholders might want to divest themselves of.

As a farming operation can be diverse and sometimes involve multiple enterprises, farmers can be counseled on the formation of multiple business entities as a vehicle to potentially isolate the liability of a less successful enterprise or aspect of the farm business from those more profitable. A situation as common as operating a roadside stand and selling out of two different farmers’ markets might warrant such an analysis.

### **Financing**

A major obstacle for many beginning and already established farmers is access to money to either purchase or operate their farming operation; or expand an existing agricultural enterprise. To this end, the SmartGrowth Business Center provides information regarding various loan programs that are available under the USDA Farm Service Agency (FSA) such as farm operating loans, farm ownership loans, emergency farm loans, guaranteed farm loans, rural youth loans, and loans to socially disadvantaged farmers, to include minority and women farmers and ranchers.

The attorneys of SmartGrowth also provide interested clients with research and information pertaining to grants and funding that are sometimes made available to the small farmer for opportunities related to sustainable farming practices.

Further assistance is provided to the clients of SmartGrowth in the form of counseling regarding loan servicing requirements on delinquent USDA loans and representation of farmers through mediation hearings and National Appeals Division hearings that could result from an adverse decision made by the agency during the loan application or servicing process.

Outreach, counseling, and legal representation of farmers is not limited to loan programs under the auspices of the USDA. Many farmers have financed their farms and their homesteads through more conventional lenders, and providing information and access to programs designed to assist struggling homeowners is an important part of the work of the SmartGrowth Business Center. The mortgage default crisis of the past few years has resulted in the birth of many programs that attempt to assist the property owner to refinance his or her mortgage loan to a more affordable level or obtain emergency funds to cure a delinquency caused by events such as job loss, disability, or illness. These programs are national in scope and are usually administered at a state level and include the Home Affordable Mortgage Program (HAMP); the Home Affordable Refinance Program (HARP); and the Mortgage Payment Program (MPP). The LLPP and its SmartGrowth Business Center have been successful in assisting both urban and rural homeowners in preserving their home ownership through working with lenders and certified Housing and Urban Development (HUD) housing counselors.

### **Contract Review**

Contracts permeate every aspect of modern American society. Farmers are parties to a myriad of contracts involving matters such as purchasing materials and supplies, obtaining crop insurance, equipment purchases, land lease agreements, promissory notes and other loan agreements and granting of security interests. In many instances, the terms of a contract can be lengthy and confusing and the ramifications for a breach can be onerous.

An unsuspecting farmer could be in breach of a crop insurance contract should he or she not follow specific contractually mandated procedures after a crop failure. Loan closing documents can sometimes contain descriptions of property to be pledged as security that the borrower never intended to be used as collateral. Specific procedures might be required in order to terminate a contract. These are some of the problems that arise in modern commerce and it is wise for a farmer to have an understanding of his or her contracts. This is another service that is provided by the attorneys at SmartGrowth.

### **Branding Your Business**

A farmer's product can sometimes be accessed by the consumer in various arenas, including Community Supported Agriculture (CSA), roadside stands, farmers' markets and retail outlets. Farming is a competitive enterprise and farmers should be counseled on the tools available to them to "brand" their product so that their product and the quality associated with it are readily identifiable to the multi-faceted and mobile consumer who many times will buy his food from more than one specific location or type of outlet. To this end, it is important to educate the small farmer on the availability of trademark protection on the state level, a procedure less cumbersome and more affordable than nationwide protection through the federal system. For example, the procedure for trademark protection in North Carolina requires a filing with the North Carolina Secretary of State, accompanied by a \$75 filing fee that provides trademark protection for an initial period of 10 years, with the option to renew for subsequent 10-year periods. An added benefit of trademark protection under the North Carolina system

is that an established trademark is assignable and thus is an asset of the farming operation that can have value in any subsequent transfer of farm ownership. North Carolina law also provides a procedure for an owner of a farm to have the name and description of the farm recorded in the local county office, a tool that could assist in avoiding confusion to the public over another farm in the local vicinity attempting to use a similar name.

### **Securing the Farm Land**

A recurring challenge in North Carolina and on a national level is the existence of heir property, land in which multiple individuals possess a fractional ownership interest in an entire parcel, usually caused by land passing in the absence of a will to multiple family members over generations. In many instances, an individual heir may be farming the land with the verbal consent of some or all of the other family members, relying on the hope of ongoing unity among the family. This type of situation can eventually give rise to family disputes or disagreements over the use of the land and sometimes can result in a family member, or an outside transferee of a fractional owner's interest, bringing a partition action under state law procedures that can oftentimes result in the land being sold. Under North Carolina law, all heirs of property that is passed without a will are classified as tenants in common with the other heirs. This co-tenancy classification does not confer on each heir an interest of sole ownership in a specific portion of the deceased's property. It creates an interest in the entire property that corresponds to a percentage ownership set by state statute. This gives rise to each cotenant having the right to the use of all of the property with certain restrictions to account to all of the co-owners for any profits gained and to refrain from activities that can cause damage to the property. Under this system, any cotenant, no matter how small his or her interest is, can seek relief from the court to have the property split up or sold, with the proceeds from a sale distributed to the multiple owners pursuant to their ownership percentage. In many instances, the court will find that the property cannot be split in an equitable manner and will order the entire parcel sold at auction. At a minimum, any individual family member who is farming the land with the consent of the other owners should be encouraged to engage in a formal lease agreement in order to secure the use of the land for a desired term of years in the event of sale. Farmers are also counseled in matters related to succession planning through the use of a will and business entity formation.

### **Market Analysis**

Market analysis enables the farmer to grow the profits of a farming enterprise. What sells at one farmers' market location as opposed to another? What prices are consumers prepared to pay for the same product at different locations? What is the local competition for the same product at the same time of year? Is it cost effective to produce an out-of-season crop? What is the cost of production of each crop and how do you measure this? What rules and regulations must be followed to gain organic certification and what costs are associated with this? Is your market brand loyal, quality driven, price driven or a combination of all of these?

Market analysis is an ongoing process that relies on many factors including record keeping, personal observation and a little bit of intuition. Published materials and other educational resources are available to the small farmer who wishes to study and put into practice successful analysis techniques that have been and are continued to be used by others.

### **SmartGrowth and Healthy Communities**

Small farm enterprises create healthy communities by producing high quality, wholesome foods for local and regional consumption. The use of environmentally sound and sustainable methods of

agriculture can enhance the well-being of an extended community by providing affordable nutrition while protecting the local environment. The successful small farmer is more likely to reinvest or distribute his or her wealth into the local community where the farmer lives and works, creating a multiplier effect. Preservation of farm land serves as a bulwark against declining property values associated with foreclosure and a lack of succession planning. SmartGrowth continues to witness small farmers succeeding, growing and flourishing through the use of sound business practices and an understanding of the laws, rules and regulations that govern present-day commerce.

This seminar and handout do not constitute legal advice. This seminar and handout do not form an Attorney-client relationship.

### **Addressing Farm and Land Losses for Minority Farmers and Forest Landowners in Virginia**

*Peter Callan, Virginia Cooperative Extension, Culpeper, Michael Lachance, Agriculture and Natural Resources, Lovington, Robert Andrew Branam, The Branam Law Firm, Hillsborough, NC*

### ***Addressing Farm and Land Losses for Minority Farmers and Forest Landowners in Virginia***

**Peter Callan**

**Farm Business Management Agent**

**Virginia Cooperative Extension,**

**Culpeper, VA**

**Michael Lachance Agriculture and Natural Resources Agent**

**Lovington, VA**

**Robert Andrew Branam**

**The Branam Law Firm, Hillsborough, NC**

### **Background**

USDA-National Agricultural Statistics Service (NASS) data shows that the number of farms owned and operated by African American farmers in Virginia decreased from 11,621 in 1964 to 1,680 in 2007. For the same period, farmlands owned by these farmers decreased from 699,554 acres to 182,713 acres. Reasons for farm/land loss have been attributed to many reasons, such as family disputes, lack of interest from younger generations, failure to pay taxes, urban sprawl, foreclosures, and lack of knowledge in estate planning strategies. To address the issue of land/farm loss, Virginia Cooperative Extension (Virginia Tech and Virginia State University) developed a Farm/Land Loss Prevention and



Transition Program with an overall goal of providing information and technical assistance to African American farmers in order to increase the in long-term survival in farming and land ownership.

The Farm/Land Loss Prevention and Transition Programs were held at African American churches located in southeast Virginia, which has the state's largest concentration of African American farmers. Pastors promoted the programs by announcements in church bulletins and during Sunday services.

Virginia Cooperative Extension (VCE) agents Peter Callan and Michael Lachance, and attorney Andrew Branan developed a 6-hour training module that was conducted on a single day to meet the time constraints of this community. Topics included: family communication; net worth and creation of a balance sheet; how family members and their advisors preserve human, intellectual, and financial capital for subsequent generations; family governance; wills, power of attorney; advanced medical directives; and overview of estate planning tools. Family members' goals, analysis of resources and operating environment, economic viability of the farm, and financial management abilities of the younger generation are among the crucial areas that need to be addressed in developing a farm transition plan. Communication within the family is the most important factor in developing a farm transition plan and was emphasized in all modules.

### **What Needs to be Decided**

The decision to transfer the farm to the younger generation should be the culmination of many years of discussion between the younger and older generations. All farms will be sold and/or transferred at some time in the future. The following is a list of possible transfer options that all farmers need to consider:

- Continue to farm as a full-time operation
  - Older generation is active partner
  - Older generation phases out of management
  - Older generation gets out completely
  - Both generations involved vs. one generation
- Operate farm as a part-time operation
- Lease the farm
- Sell the farm
- Sell the farm and purchase a farm in another area (Section 1031 Like-Kind Exchange)

If children do not want to work on the farm, then the parents must develop an exit strategy to preserve equity. The parents' retirement may come directly from the farm sales unless there are other sources of retirement funds.

If a child wants to return to the family farm, these questions should be discussed and addressed:

- Is the farm profitable? If the answer is no, then can changes be made that will generate a profit?
- What will be the farm's operating environment over the next 30 years?
- Does the farm have a sufficient land base, or can additional land be rented?
- Are there development pressures?
- Will there be equipment dealers, feed mills, or vet service in the years ahead?
- Is it feasible to service the additional debt incurred by an expansion?

Before the younger generation returns to the home farm, there needs to be a frank discussion between the older and younger generations. Why do they want to operate the farm?

- Are they serious about managing the business, or is this a way to please Mom and Dad?
- Do the younger children have the skills to operate the farm?
- Do the children enjoy working with the financial and farm records?
- What is the younger generation's work ethic?
- Are they willing to put in long hours?
- Do they have a passion for agriculture?
- Are they willing to learn new ideas by attending Extension meetings, participating on farm tours and reading?
- Can they handle the emotional pressures of having several years of drought or low prices?

If the families can honestly answer yes to nearly all the preceding questions, then the family should consider initiating a program to transfer the farm to the younger generation. However, the ability of the younger generation to manage money must be one of the key considerations in considering transferring the farm to the younger generation.

It is difficult for a parent to say to a child that they do not have the ability to manage a farm in a highly cyclical industry that requires big investments and provides historically low rates of return. Does the older generation want to see financial assets that they have built over several generations put at risk? And under what conditions can they afford to risk that capital?

When the older and younger generations have made the decisions to start the process of considering transferring the farm to younger generation; the following business goals should be discussed and addressed?

- Matching farm labor demand/supply
- Level of risk and how it is managed
- Level debt and repayment capacity
- Matching farm size and enterprises to future needs to expand or contract
- Lifestyle and farming
- Time away from operation
- Future management responsibilities

### **Communicating Across the Generations**

There may be expectations between generations that have changed over time. For example, there can be differences in the balance of time spent engaging in family, recreational, work, and community activities. An important area to consider is the amount of farm profits reinvested in the business or spent on family living expenses. If the older generation is unable to spend time training the younger generation to assume management responsibilities, the younger generation should seek training elsewhere. A successful transition occurs when these issues are resolved.

Management responsibilities will be increased as the younger generation proves that it can successfully manage its area of responsibility. During this transition period, the younger generation will be growing and creating equity for the entire farm. As part of the farm transition plan, a portion of the farm's equity will be transferred to the next generation. The difficult issue is when the older generation will turn over all the management control to the younger generation. The transfer process has to be structured to provide security for the older generation's equity. Every family is different. My observation is that overall management control is transferred to the younger generation when equity is at a level where the younger generation must take full responsibility for managing the business.

On many farms, the older generation operated the farms on a full-time basis and lived a low standard of living in order for the farm to generate a positive cash flow. Today, many of these marginally profitable farms are operated on a part-time basis.

Many young farmers work full-time off the farm and operate the farms on a part-time basis because it is difficult to generate sufficient profits to provide all of their family living expenses. The farmers selected enterprises that would generate sufficient revenues to meet part of their family living expenses.

In 2008, the Bureau of Labor Statistics estimated that the average family living expenses were approximately \$50,500. Likewise, many producers are converting commercial agriculture (corn, soybeans, cow/calf, etc.) to producing and marketing crops as value added products (e.g. farmers markets, community supported agriculture) as a means to increase income. In addition, time away from the farm is another important consideration in the selection of enterprises.

Unlike many of their predecessors, many younger farmers want to have more time to spend away from the farm. They do not want to be tied to the farm 24/7. Since many of the younger generations' spouses are from nonfarm backgrounds, they seek enterprises that will enable them to have a balance between work and family activities. When the younger generation is considering taking over the farm, we recommend holding a discussion between the spouses and their children regarding the expectation of labor contributions to the farm operation. Unless this discussion takes place there may be differences in expected labor contributions of the farm operator and family members.

The ability of the younger and older generations to talk about their goals and be willing to compromise is critical in transferring the farm to the next generation. In order to be successful, the older and younger generations need to communicate their goals to family members. Mind reading is not allowed! Likewise, goals can be revised to meet the needs of family members. Communication is the key to developing a farm transition plan.

We help families understand the barriers which can prevent them from having an open and meaningful discussion.

- Joint ownership must be established for effective communications
- How to listen and be heard
- Honesty about the issues will establish trust
- Nothing should be taken for granted
- Understand the role of body language, environment/location for discussion and the implication to reaching a consensus

An environment that limits distractions is important. Understanding how to reduce the barriers to effective communication between the older and younger generations about the future of the family farm is crucial. Establishing a good/safe environment will allow the hard work of addressing family issues that can be a source of contention between siblings or between siblings and parents to be tackled. Examples of such issues could be borrowed funds not paid, lack of mutual respect for each family member's goals, age and experience, "difficult" personalities" and using guilt to "control" family members.

### **Engaging and Educating the Younger Generation**

Michael Lachance, Virginia Tech Extension Agent, has developed a presentation on the importance of preserving and educating the younger generation on their family's values. Lachance's presentation has consistently received high ratings on program evaluations. A summary of Lachance's presentation on the preservation of family values is listed below:

Family wealth activity is the pursuit of collective financial planning, that allows an extended family to put resources into long term strategies. These plans are often made for periods lasting 50 years or more. The idea of family wealth development comes from the past experiences of families of great affluence, often thought of as family dynasties. Their strategies of long-term financial planning and legal counsel have been adapted for a much broader spectrum of families, including those that are interested in transferring rural land resources from one generation to the next. The goal of adopting these approaches is to sustain wealth and individual accomplishment over succeeding generations, including the retention of farm and timber land within the extended family. By careful planning, families can avoid financial loss, chronic indebtedness, and maintain a high regard for the family over time.

Family financial planning should begin by realizing that its members may include people beyond "family" as defined as parents and siblings. It can include cousins, spouses, in-laws, and even people with no blood or marital connections who share a common vision for sustaining a legacy over time. These people agree to come under some form of family governance structure for accomplishing long-term planning. Points of agreement within the group of people wanting to maximize family wealth will include a shared belief in the stated values and goals of the group, understanding of what is to be gained by aligning with others, accepting joint decisions across and within generations, agreeing to minimize disputes, and engaging in trans-generational activities. There is also a commitment to develop means of effective communication within the family, emphasizing the positive, and keeping criticism and blame to a minimum. Family members can certainly gain effective communication and decision-making skills by looking for opportunities to serve on civic and faith-oriented activities where joint decision-making is required.

People should strive to meet the following goals: identification of shared values, creation of a family mission statement, identification of each family member's talents and skills, conscious efforts to improve family relationships, and selection of competent legal and financial advisors from outside the family. Outside advice is needed because flaws are too often a part of family dynamics. Families are subject to hostility and non-communication, parents and siblings fighting over roles/control of family assets; spouses feeling themselves unheard; discomfort about and by family members with dysfunctional traits; individual's sense of lack of accomplishment; the lack of mental readiness by the inheriting generation and/or spouse; a sense of over-entitlement in some/all heirs and their spouses; sudden changes such as divorce, illness, and death; and the need to respect the charitable wishes of a donor.

From the onset, family members must be aware that wealth means much more than access to capital for business planning. A family's primary wealth rests with people's human capital, (i.e., the aptitudes that

individuals possess, and their intellectual wealth or what each individual knows). Money/capital needs to be seen as secondary wealth.

Is your family ready to discuss family wealth? Learn what are the potential risks of bringing everyone to the table by first assessing your family's unity and shared values. Then, take time to prepare for open discussions about finances, education, etc., by seeking out books and other media that can be shared with family members. An excellent example is the text *Family Wealth--Keeping It in the Family: How Family Members and Their Advisers Preserve Human, Intellectual, and Financial Assets for Generations* by James E. Hughes Jr.

### **Getting Started**

Assessment activities and audits of people's estates can get the process started. It is important to do careful planning prior to holding a meeting where wealth transfer issues are discussed. Announce the event to all family members and pay attention to the importance of selecting the right location. Someplace away from family member homes is often desirable. Explore strategies and exercises to start and broaden conversation, and determine who leads or facilitates the discussion; perhaps, someone from outside the family is better placed to lead the discussion. Make sure everyone gets a chance to speak and rules of civility are adhered to. Finally, acknowledge but avoid speaking about negative or uncomfortable aspects of the family, and agree on what each generation needs to know.

The most important factors for managing family wealth are developing and preserving high levels of trust and communication among family members, preparing heirs to think about wealth and taking responsibility, and reaching agreement on the mission of the family's wealth. With that done, a family's professional advisors can realize that the entire family is their client.

Here are some ideas to foster family wealth management: (1) Develop a mission for the family wealth, along with a strategies and roles to accomplish it; (2) Have family members prepare themselves as competent managers of all or part of the family business, charitable foundation, or other entity that represents a large amount of capital; (3) Develop standards, such as successful work experience outside the family as preparation for specific future roles, and (4) Do not overlook the assistance that can be provided by outside resources, such as your state's Cooperative Extension programs.

### **Defining Farm Transfer and Risk Management Planning**

"A process of decision-making that protects your farm's productivity while preserving family and enhancing community development."

**Process:** Protecting your farm and business from risk, and once documents are in place, they must be revisited over time.

**Decisions:** Choices and decisions must be made about how you will handle the distribution of income, management duties, and ownership of your wealth (farmland and/or business). Once made, the door can be left open for new decisions to be made (remember, it's a process).

**Protects:** Protecting what is important to you (a farm in the family, a business in the family, a resource in the community, your wealth) by putting the instruments in place to manage risk (e.g., insurance, a clear distribution in an estate plan, a business entity and good agricultural practices etc.).

**Preserves:** At the end of it all, how well your family gets along is what really matters, that is your true legacy. Unclear decisions about the distribution of land (or more directly, placing heirs in co-tenancy on that land) have a way of splitting families apart.

**Enhances:** The decisions made on a farm and the community around it are symbiotic (decisions based on opportunities in an area depend on that area's infrastructure and resources). Public support of your endeavor is related to its value to the community.

### **Planning the Future of Your Farm: A Suggested Process**

You and your spouse should ask yourselves three key questions:

- What do we want?
- What do we have?
- What do we need?

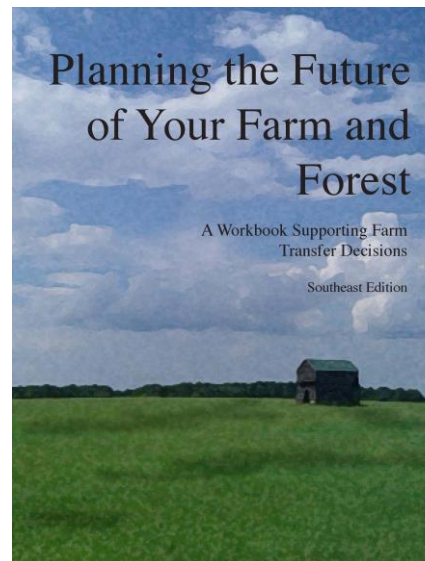

family

#### **What do you want?**

Create your own vision of the future and share that with your to get their input. But it is *your* vision. You must create a narrative that your family and your professional advisers can understand.

#### **What do you have?**

What resources – financial, farm, family, and community – are available to you?

Be realistic about what wealth you will need to retain for your retirement and care in later years. Secure income streams to cover expenses, and retain control over sale of assets in case income is insufficient. Also, what peace do you need to maintain in your family, and what are the needs of business or farm successors to help you see your vision through?

What is your property, your stuff, and how is it owned? How much is it worth? Do you have a viable business? Do you have available the natural, human and community resources to support that business or manage the land?

#### **What do you need?**

What tools do you need to order the transfer of your farm to accomplish your goals, to keep it in production, to be fair to your children? What income do you need to live comfortably?

#### **Planning the Future of Your Farm: Getting Started**

Take small steps if you have to, first getting your estate plan in order, or placing your business assets in a limited liability company for liability protection and more orderly management, obtaining insurance. You don't have to do it all at once, remember that it is a process.

What certainly helps is to engage with some knowledgeable advisers with whom you can build trust, can get to know you and your family and financial circumstances, and can support your business, at reasonable cost, along the way. Make sure your advisers understand what you want, be confident in your vision, and find someone who will help you minimize the risk to make it happen.

Always remember: "Help me" is more affordable than "Fix Me."

Program Impact

It has been difficult to gather information regarding the impacts of the farm transition programs that were held at African American churches. Pastors of churches that sponsored the farm transition programs have indicated that there is a great need for farm transition planning within the African American community. The pastors feel that many families are ashamed to discuss farm transition planning with their pastors and close family friends because the farms are owned by numerous heirs scattered throughout the country.

Many of these families must coordinate/commutate with numerous children and grandchildren across a large geographic area. The older generation left the farm to all their children jointly and in some cases without a will making clear title to real property difficult and expensive to establish. This is further complicated by two additional items:(1) some heirs left the farm as young adults and are not interested in ownership of the farm; (2) the structure of the farm (lack of profits) reduces the ability of the heirs on the farm to buy out the interest of the farm owned by their off farm siblings. Consequently, all the siblings retained ownership of the farm adding complications to farm survival.

Follow-up surveys indicated that some of the program participants have “tweaked” their estate plans by developing an inventory of farm and non-farm assets (e.g., resource inventory) and made plans for long-term health care. However, discussions with the pastors have indicated that they feel that there are few families who have made plans to transfer the farms to the next generation. Thus, they feel that there is a great need for educating African American families on strategies to transfer land ownership to the next generation and avoid selling the family farm. The follow-up surveys have indicated that there is a dire need for families to have individual consultations with attorneys to resolve legal issues on their farms.

Due to limited resources, many families are not able afford the legal services needed to explore and pursue legal options that will enable them to transfer ownership of their farms to the younger family members who are interested in operating the farm. The Virginia Tech Extension/Virginia State University Farm Transition Program has been funded by a grant from the Virginia Department of Agriculture and Consumer Services. Since public funding cannot be used to pay for individual legal consultations and creation of legal documents (wills, LLCs, trusts, etc.), a source of funding needs to be acquired to support the legal services needed to transfer their farms to the next generation. By having access the free legal services, limited resource families will be able to maintain ownership of their family farms by transferring the farms to the next generation in their families.

## **Session 2 D**

**Track/Session: Program Planning and Implementation/Successful Educational Programs Part II**

**The USDA NRCS Organic Initiative: Supporting Conservation on Organic Farms**

**Sarah Brown, *Oregon Tilth***

**The USDA NRCS Organic Initiative: Supporting Conservation on Organic Farms**

**Sarah Brown**



## Oregon Tilth, Corvallis, OR

### Introduction

Oregon Tilth has developed a strategic partnership with USDA's Natural Resources Conservation Service (NRCS) to improve their ability to provide technical and financial assistance to organic producers through the Environmental Quality Incentive Program's Organic Initiative (EQIP OI). Started in 2010, Oregon Tilth's national Organic Conservation Program (OCP) is aimed at building the capacity of the nation's conservation system to support organic farming. It provides a coordinated educational program that will increase organic producers' understanding of conservation funding and technical assistance available through NRCS, and enable NRCS staff to better assist these producers in implementing cost-effective, productive, sustainable conservation practices on their farms and ranches.

Since 2009, less than half of the annual \$50 million made available by NRCS for the implementation of conservation on organic and transitioning operations has been utilized. The EQIP OI has also been challenged by limited NRCS understanding of organic production practices and certification regulations, insufficient technical resources for conservation plan development, and inadequate coordination of NRCS, organic certification, Extension, and other agencies and programs. In all regions, conservation professionals have indicated the need for information and training specifically adapted for local ecosystems and production systems, for example, cover crops and buffer establishment for pollinator habitat.

The OCP fills an important need to apply systems-based conservation and organic agriculture research to professional development training and help the public conservation system advance the viability and enhance the benefits of organic farming.

### **NRCS EQIP Organic Initiative Program Details**

The 2008 Farm Bill included provisions for the use of EQIP to provide opportunities for organic producers to address natural resource concerns. This assistance helps producers plan and implement conservation practices to improve environmental sustainability. Some highlights of the Organic Initiative include:

- Assistance for conservation practices and planning related to addressing resource concerns as part of organic production
- Assistance is limited to \$20,000 per year and \$80,000 during a six year period
- Eligible applicants include :
  - Certified organic producers
  - Transitioning to organic production, or
  - Producers selling less than \$5000 organic products annually

The Organic Initiative provides financial assistance to implement a broad set of conservation practices to assist organic producers in meeting their resource concerns and fulfilling many of the requirements of the NOP regulations including, but not limited to assistance with:

- Developing a conservation plan
  - Establishing boundaries and buffer zones
- Improving soil quality and organic matter while minimizing erosion
  - Improving pest management
- Developing a grazing plan and improving grazing resources
  - Improving waste utilization and composting
  - Improving irrigation efficiency
- Enhancing cropping systems and nutrient management

NRCS Organic Initiative Website:

[http://www.nrcs.usda.gov/wps/portal/nrcs/detail/national/programs/financial/eqip/?&cid=nrcs143\\_008224](http://www.nrcs.usda.gov/wps/portal/nrcs/detail/national/programs/financial/eqip/?&cid=nrcs143_008224)

### **Figure 1. Organic Initiative Program**

#### **Objectives**

Oregon Tilth develops and implements educational programming designed to increase the usage of conservation practices that reduce soil erosion, increase water use efficiency, improve soil and water

quality, and increase pollinator and wildlife habitat on organic and transitioning farms. Working within the NRCS provides an opportunity to institutionalize organic agriculture expertise via practical applications of technical assistance as well as changing cultural misperceptions toward organic management systems within the agency. The project also aims to promote NRCS resources to organic producers and agricultural service providers in order to help improve conservation and production outcomes, which ultimately increases the number of successful organic farms. The project's success will reflect increased levels and enhanced support and resources for organic farmers in NRCS, and more broadly, in USDA.

## **Program Description**

### *Opportunities*

In order to meet 2012 NRCS requests for assistance with limited staff capacity, a survey was disseminated to prioritize the states and projects with the greatest need for assistance.

- 89 percent of states need some type of assistance related to the implementation of conservation on organic farms
- 85 percent of respondents reported needing assistance with outreach to organic and transitioning to organic producers
- Close to 60 percent of respondents identified the need for an intermediate or advanced level training while 30 percent need an introductory course.
- The development of organic technical resources continues to be a priority. Top practices needing assistance remain consistent: Integrated Pest Management (IPM), Nutrient Management, and Cover Crop Management.

### *Activities*

OCP provides training through regional one- and two-day workshops for NRCS staff on organic production and conservation practices for organic farms. Curriculum is adapted for relevance to local crops, conditions, and needs and is responsive to timely issues and emerging trends. Content emphasizes similarities and differences between the needs of organic and conventional producers for conservation assistance, general information on organic production, and key considerations for assisting organic and transitioning producers with planning and implementation of conservation practices. The workshops familiarize participants with the principles of organic conservation, increase their comfort level delivering the EQIP-OI, and bring them into a network of expertise, resources, and support for organic producers.

Additional activities include:

- NRCS EQIP Organic Initiative programmatic support
- Facilitation and coordination among partners
- NRCS EQIP Organic Initiative outreach strategy development and support
- Presentations and trainings to partner and producer audiences
- Annual NRCS Organic Webinar Series

### *Lessons Learned*

- Acknowledge consumer hype/myths regarding organic
- Recognize the spectrum of sustainability across different agricultural management systems
- Collaborate with local Extension, agricultural professionals, and organic certifiers
- Development of a national collaborative strategy helps maximize impact
- Have NRCS leadership ‘set the stage’ and lead by example
- Find articulate and educated farmer hosts/speakers
- Provide ‘safe space’ for NRCS participants to discuss farm tour
- Do not assume audience knows the basics (soil quality, mineralization, IPM)
- Organic producers need clear interpretations of NRCS language and terms
- Organic producers are hesitant to get involved with government programs

### **Results**

To date, OCP has delivered training, technical assistance, and outreach to more than 2,200 conservation professionals in all 50 states. Surveys from more than 250 conservation professionals have demonstrated significant increases in knowledge and expected ability to assist organic farmers in implementing conservation practices after participating in OCP trainings. Demand for the OCP is steadily increasing as conservation professionals and farmers request more information and assistance implementing effective organic conservation practices.

### **Future Plans**

Oregon Tilth is currently working with partners to develop a more robust strategy for providing support to transitioning to organic producers. This strategy draws on collaborations with Extension, non-profit partners, and NRCS to further develop technical and financial assistance. By working directly with organic producers, we are better able to format systems and services to meet their evolving needs. Regular needs assessments will allow us to support sound University-based research, which in turn, will be transferred back to producers and other agricultural professionals.

The OCP will continue to address underutilization of conservation programs by organic/transitioning producers, the lack of current capacity within the conservation system to increase organic participation in these programs, the shortage of expertise to assist producers in implementing and managing effective conservation practices, and the lack of coordination among conservation and organic agriculture programs.

### **Acknowledgements**

This project is partially funded by the USDA Natural Resource Conservation Service, Western Sustainable Agriculture Research and Education Program, and the McKnight Foundation. We would also like to acknowledge support from our partners; in particular, Oregon State University and members of the National Sustainable Agriculture Coalition.

For additional information on Oregon Tilth's Organic Conservation Program or NRCS programs for organic producers, please contact:

Sarah Brown  
Organic Conservation Program Manager  
Oregon Tilth  
Sarah.brown@por.usda.gov  
503-273-2433

## **Reducing Risk on Idaho Small Farms and Ranches through Innovative Whole Farm Planning Education**

*Cinda Williams, Ariel Agenbroad, Collette DePhelps, M. Lines, D. Green, Mary Rohlfing, and C. Madsen, University of Idaho Extension, Latah County*

## **Reducing Risk on Idaho Small Farms and Ranches Through Innovative Whole Farm Planning Education**

**Cinda Williams; Ariel Agenbroad; Colette DePhelps  
University of Idaho, Moscow, ID**

### **Introduction**

Cultivating Success™ Small Farm Education Program has been offering whole farm planning and business planning courses in Idaho and Washington for over 10 years. Courses have traditionally been taken by beginning farmers and people who are not currently farming, but are interested in starting a farm or ranch. One of the core Cultivating Success™ courses is Sustainable Small Farming and Ranching (SSFR). This course helps beginning farmers develop a whole farm plan and covers topics such as: resource evaluation, feasibility assessment for selected enterprises, market analysis, sustainable production practices and risk management. In response to requests from more experienced farmers, Cultivating Success™ recently developed an advanced whole farm and business planning course, Planning for Profit II, and began offering both courses online.

### **New Delivery Mode for Cultivating Success™ Courses**

In 2010, the Idaho Cultivating Success team was awarded a Western Center Risk Management Education (WCRME) grant to offer the SSFR course in an online format. This self-paced course provided an option for time-constrained and place-bound producers to gain whole farm planning knowledge and skills.

The 12-week on-line course was originally planned as a pilot for 15 people and at no cost. Students were asked to agree to help evaluate the course in return for the fee waiver. When over 60 people responded to our announcement about the course we quickly revised our plans and decided to let all those interested sign up. We originally had one experienced farmer instructor on our planning team and two more were asked to serve as instructor/mentors. Groups of 20 students were assigned to each farmer mentor; most were assigned to the farmer closest to their geographical region.

The online course participants were connected to experienced farmer mentors and course developers through a facilitated on-line Moodle format. Each week's PowerPoint presentations, readings, worksheets and discussion forums were accessed through Moodle. The weekly synchronous chat sessions with farmer mentors increased the interactive aspect of the class.

### **Evaluation of the New Delivery Method**

Besides a few technical glitches and dropout rate that was higher than we anticipated (largely due to personal life changes, some dissatisfaction with course content and the online platform), most course participants had high praise and were very appreciative of the course content and our efforts to serve place-bound and time-constrained producers. The participants of the pilot version provided the feedback that gave us the indication we needed to further revise and improve any subsequent online course offerings.

One of the challenges we encountered was a misunderstanding of the nature of the course. Despite our specific description of the course in the promotional materials, we had some who signed up thinking it was more for sustainable, subsistence farming rather than for a sustainable farm business. We had a couple drop out due to that reason and a few dropped out due to personal time conflicts and health issues. Over the last few weeks of the course, participation in the chat room and the number completing assignments decreased. We think that part of it was due to inability to keep up with the fast pace of the class and less commitment to complete assignments because they did not pay for the course.

Technology was definitely a challenge for some participants but most stuck with it and we were able to overcome some of the initial issues. Mac users were having difficulty downloading and viewing video files embedded within the PowerPoint presentations. We converted the video clips to links to YouTube videos that enabled Mac users to access them. Some students had trouble understanding the Moodle class platform; it was complex with three instructor chats and assignment upload sections. With time and technical assistance, they learned the workings of Moodle. In addition, most students and instructors had limited experience with chat rooms. Based on results of the mid-course evaluation, instructors implemented a more effective chat dialog utilizing established discussion topics and rules of conduct.

While the course was offered free because it was a pilot, many participants indicated we should have charged a registration fee in order to keep people committed. However, the no-cost offer was in exchange for a high level of required feedback and evaluation that proved very useful to the project team. The end-of-course survey indicated most participants (62 percent) felt we should charge between \$125 and \$175 for future course offerings. Farmer instructors kept track of their time and our plan is to access the total costs of offering the course to determine the funding needed for future offerings.

The SSFR end-of-course evaluation asked students to rate the effectiveness of the methods used to deliver the course content. The results indicated that 86 percent of participants thought that communication with the instructors was somewhat to very effective, while only 63 percent thought the chat sessions were somewhat to very effective. The most effective methods of information sharing were independent readings, written assignments and the online PowerPoint presentations.

### **Using Lessons Learned to Implement a Second Course**

Evaluation feedback and lessons learned from the SSFR introductory level whole farm planning on-line course were used in the development of a second, advanced whole farm and business planning course entitled Planning for Profit II. This 9-week advanced level course was funded by WCRME and taught in the spring of 2012.

In our advertisements for Planning for Profit II, we were very clear about the course content and that it was an advanced class. In addition, for the first time in offering a Cultivating Success course, we had a set of prerequisites for participation. Students had to be: 1) currently farming/ranching (for at least a year); 2) have taken one of our whole farm or business planning classes (or something similar); and, 3) have a farm, business, or marketing plan that they wanted to revise, expand, or complete. This ensured participants had the necessary background knowledge and materials needed to understand the course

content and undertake the more in-depth assignments which often included review and modification of existing planning documents.

More specific technology requirements for both PC and Mac computers were provided on the course website and sent to students when they registered. Students were required to complete a survey that provided information on their computer system and capacity. Almost all students talked to a project coordinator to confirm experience level and technology prerequisites before finalizing their registrations.

This course also used the Moodle format as the connection for readings and assignments but instead of PowerPoint presentations we introduced weekly 'live' webinars using GoToWebinar™. The webinars were 1½ hours with multiple instructors and/or guest speakers and PowerPoint presentations. Multiple speakers helped maintain student interest. We included Q&A sessions periodically during the webinar and also added participant polls (questions and results displayed during the webinar) for a more engaging, interactive learning environment. We eliminated the chat sessions because they scored so low in the SSFR evaluations. Instead participants could post to and respond via weekly discussion sessions to follow up on key topics or questions that arose during or after the webinar.

### **Evaluating Delivery of Webinar-based Course using Moodle Platform**

Thirty-two producers completed the advanced Planning for Profit II course with only one dropping the course due to computer hardware problems. Post-webinar and end-of course evaluations indicated a high level of student satisfaction in the course content and delivery method. In the end-of-course evaluations, over 85% of participants indicated independent readings, resource materials on the course website and webinars as being effective to very effective learning methods. A slightly lower percentage – 76 percent - rated course assignments as effective or very effective. Interestingly, the discussion forums, which were considered effective in the SSFR basic course, were rated as minimally to somewhat effective by Planning for Profit II participants. We believe this difference has to do with the efficacy of webinars as a learning method. When asked how easy or difficult using the on-line course platform (course website on Moodle) was for navigating the course, most participants found it easy to access the readings, assignments and YouTube links. There was slightly more difficulty accessing the webinar Window Media files and communicating via the discussion forums.

### **Evaluation and Impacts of the Course Content - SSFR**

The 2010 online SSFR course was an overall success as a pilot test. Despite a few technical glitches and a dropout rate that was higher than anticipated, end-of course (EOC) evaluations still indicated a high level of knowledge gain among participants.

As part of evaluating the online version of SSFR, we compared the knowledge gain and learning outcomes of the on-line version of SSFR with those of three in-classroom versions of the SSFR course (offered in fall 2010). Sixty-five students took the online version of SSFR and 29 students took the in-classroom version. Forty-one (63%) of the on-line students and twenty (69 percent) of the in-class participants completed the EOC.

The level of knowledge increase among students was 10-15 percent lower in the on-line course when compared to those attending in-person class sessions. For example, EOC surveys showed the following percentage of students indicating knowledge gain in the following topics: Purpose/importance of developing a whole farm plan (100 percent - in class; 87 percent on-line); innovative marketing strategies (95 percent - in class; 80 percent on-line); pest and soil management (100 percent in class; 83 percent on-line) and ways to improve farm profitability (95 percent - in class; 86 percent on-line). However, actions taken as a result of participating in either class were largely the same. For instance,



when asked about actions taken as a result of class, 89 percent of in class and 86 percent of on-line students had completed a whole farm plan.

### **Evaluation and Impacts of the Course Content – Planning for Profit II**

The Planning for Profit II (PPII) evaluation measured participant knowledge change; preparedness related to planning, financial analyses and risk assessment; and, business and whole farm planning steps taken as a result of participating in the course. Twenty-two students (69 percent) of course participants completed the EOC.

As a result of participating in the PPII course, over 90 percent of project participants reported an increase in knowledge in the following areas and 70 percent indicated a ‘significant’ increase in knowledge: how to assess the viability of a new farm/ranch enterprise; how to undertake farm/ranch financial planning; how to monitor and evaluate a farm financial plan; how to evaluate the potential of one or more direct or semi-direct markets; and, how to evaluate the profitability or potential of specific marketing strategies. There was a slightly lower increase in overall knowledge, 60-70 percent, in the areas of assessing labor, food safety and urban farming risk factors.

Over 75 percent of course participants indicated a high level of preparedness with respect to goal setting, testing decisions against goals, SWOT analysis, and exploring new markets. Participants also felt prepared to develop a record keeping system, create and use financial reports, assess labor options and evaluate risks for which they might need liability insurance. During the course, over 90% of participants developed, reviewed and/or improved their budgeting and financial record keeping; financial goals and marketing plan and 50% engaged in risk management and food safety planning.

#### **Impacts: Quotes from Students of Planning for Profit II:**

*Based on what we discovered during the holistic planning process, we know that we want to continue farming and have a good sense of why! We also know that in order to continue farming, we need to make some changes in time, money, and energy spent.*

*Our upcoming season will have a more honest and realistic assessment of expenses (including our time) and income.*

*We are also implementing a new strategy to keep farm yield records. We will have the data sheets already printed out and in a notebook, ready to go before the first harvest.*

*No more random pieces of paper, hand-scrawled notes everywhere....*

*We have assessed the possibility and reality of three new markets and decided to go for it! Minimal extra time, with lots of extra rewards.*

#### **Conclusion**

Offering Cultivating Success™ courses online has expanded beginning farmers, people exploring farming and experienced farmers’ opportunities for whole farm planning and business planning education. Our evaluation of the SSFR and Planning for Profit II courses shows that online learning is an effective educational method worthy of consideration and adoption by other small farm educators.

#### **Challenges for Improved Crop Insurance for Small Farms: The Case of Whole Farm Adjusted Gross Revenue Lite**

*Jeff Schahczenski, National Center for Appropriate Technology*

***Challenges for Improved Crop Insurance for Small Farms:  
The Case of Whole Farm Adjusted Gross Revenue Lite***

**Jeff Schahczenski, Agricultural Economist  
National Center for Appropriate Technology**

Can the lack of profitability within the small farm sector despite growing market demand for their products be explained in part because of the lack of adequate risk protection generally and because of inadequate crop and livestock insurance specifically? Achieving year-to-year profitability in farming is not easy, and most farms do not do so (Schahczenski, 2011). In particular smaller farms, as measured by gross annual income, are among the least profitable farms. In 2007, almost 900,000 farms with total gross annual cash income of \$10,000 or less also had negative operating profits (Hoppe, et. al., 2010). Profitability for smaller farms only seems to turn positive on average only when gross cash farm income exceeds \$50,000 (Hoppe, et. al. 2010). However despite the difficulties in farm profitability, the rise in local and regional specialty markets have provided new opportunities for smaller farms. For instance, direct marketing to consumer of farm products has been expanding where direct marketing of all types of was valued at over one billion dollars and has grown 105 percent in value from 1997 to 2007 (Diamond & Soto, 2009). With growing importance of this sector of the farm economy it is important to understand how risk management generally and crop insurance specifically can assist with improving farm profitability.

The Risk Management Agency (RMA) of the United States Department of Agriculture has offered a unique federally subsidized whole farm revenue insurance product called Adjusted Gross Revenue Lite (AGR-Lite) which has the potential to provide some protection for the smaller diverse farms<sup>1</sup>. Although still only available in 38 states, AGR-Lite is a significantly different approach to crop insurance which insures the historic average adjusted gross revenue of the farm regardless of the variety of products the farmer grows. Insuring whole-farm revenue, rather than buying individual policies for separate crops and livestock, is generally less expensive because the risks of loss are pooled across the various crops and livestock products. Despite this seemingly ideal form of insurance for smaller diverse farms, AGR-lite is not readily used with only 531 policies sold nationwide in 2011.

For the last four years the National Center for Appropriate Technology (NCAT) has work with RMA in several research and extension outreach efforts to improve understanding of AGR-Lite among smaller diverse, specialty and organic farmers. This work in included the development of a unique software assessment tool called the AGR-Lite Wizard which is widely available on-line (<https://www.agrlitewizard.com/>) or in a CD format for use on personal computers. While these efforts have brought greater national attention to the possibilities of whole farm revenue insurance for the smaller diverse farms, significant problems remain. There are three general areas of challenges that we

---

<sup>1</sup> There is also a federally subsidized product call adjusted gross revenue or AGR. This product is very limited in availability but is similar to AGR-Lite accept that the maximum level of coverage is much higher than the “lite” product.

have identified for improving crop insurance for the smaller diversified farmer, each are reviewed below.

**Federally subsidized whole farm revenue (AGR-Lite ) coverage levels need to increase so as to be at least equivalent to other types of single-crop insurance products.**

There are many forms and types of federally subsidized crop insurance policies available nationwide. However, most federally subsidized policies sold in the United States are for either revenue or yield protection for major commodity crops. Just five of these commodity crops—corn, soybeans, wheat, cotton, and rice—represent the bulk of crop-insurance coverage in the United States, accounting for over 77% of the total liability coverage purchased by farmers in 2010 (Schahczenski, *forthcoming*). These policies are crop specific and to the extent a farmer grows only a few these crops the cost of coverage is fairly low and the coverage quite good with effective coverage levels of up to 85% of the historic average crop revenue.

In our work with smaller diversified, specialty crops, and organic farmers who could potentially use the AGR-Lite whole farm revenue product, it is very clear that the effective coverage rate of 72% of the historic average adjusted gross revenue is insufficient coverage to make the product attractive to this segment of agriculture. Again because the insurance covers historic average revenue of the farm, the farmer could potentially suffer a 28% whole farm revenue loss before any insurance loss or indemnity payment kicks in. Thus it is hard for a farmer to justify the cost of a whole farm revenue product if they would have to first experience a 28% whole farm revenue loss before receiving any benefit from the policy. While this level of coverage is better than no coverage at all, it still is not sufficient coverage relative to its cost to be attractive to many potential diversified smaller farms.

The other type of insurance product that a smaller diverse farmers could obtain as an alternative to whole farm revenue insurance are generally known as “specialty” crop insurance. However, these policies are only available in a limited number of areas in the country where larger scale, often monoculture production of the crop already occurs and generally only offer yield and not revenue coverage. For example, there are yield protection policies for blueberry production, but they are limited to very few counties in the United States. Thus if a diversified farmer wants to incorporate blueberries into an already diverse farm operation with other horticultural and soft fruit production, the probability is low that an insurance option is available. Furthermore, the costs of buying individual policies for potentially dozens of different crops even if available would be great even if the coverage for each crop specific policy is better. Thus with the exception of whole farm revenue option, the more diverse or specialized the crops and livestock you grow, the more difficult it can be to obtain insurance to fully cover the value and risks of that production.

**Whole farm revenue (AGR-Lite) premium costs need to decline more significantly as farm crop and livestock diversity increases.**

AGR-Lite whole farm revenue insurance is unique in that because farm revenue is the object of insurance, the value of the products of diverse mixed livestock and cropping systems or even the higher valued products of organic production are protected up to the level of coverage offered. This generally lowers the premium costs then would otherwise be the case if individual policies were purchased for each product. However, the current AGR-Lite policy does not lower premium costs proportional to the number of crop or livestock products grown.

This finding came from our research efforts in interviewing farmers who used the AGR-Lite product. One interview with a farmer who had purchased an AGR-Lite policy aptly illustrates this issue well. This 1,700 acre farm was unique in that that it was an organic farm yet fairly conventional in terms of types of crops (e.g, corn, wheat, soybeans and hay) and livestock (sheep) products produced. The farmer’s original interest in AGR-Lite was because of his desire to be fully insured for the organic value of his crops which fetched significant premium prices. Under all other crop insurance options, this farmer would be required to pay a premium surcharge for most of his organic crops and could only cover them at their lower non-organic value. However after using the AGR-Lite Wizard tool developed in our project, he actually decided **not** to purchase another AGR-Lite policy. As this farmer stated on his evaluation of AGR-Lite, “If I had this tool to use when I was deciding whether or not to buy this insurance, I probably wouldn’t have bought it.” When asked what his reasoning was for this statement, his response was that that he felt that premium costs did not drop proportionally to the lowering of risk as additional crop or livestock enterprises were added to the farm, thus not providing ample coverage at a reasonable cost for all the products grown. This could easily be improved by the RMA.

**Application processes and information intensity for whole farm revenue (AGR-Lite) insurance should be minimized as much as possible.**

AGR-Lite requires that the historic farm revenue estimation be based on IRS tax records and by providing additional information on expected production and revenue for the insurance coverage year. Also the revenue reported on IRS tax records needs to be adjusted so as to limit added-value activities from being the basis of the insurance coverage, hence the reason the product is called “adjusted” gross revenue lite. This complexity arises because the data for historical revenue and premium estimation taken from IRS tax records don’t easily sort out the sources of revenue for a farm. So for instance if a farmer grows apples but also processes some of those apples for an apple cider product, the apple and apple cider revenue are often combined for tax purposes. Since RMA is in the business of using public money to subsidize crop insurance it does not want to also create a federally subsidized product that also insures an apple cider business. However, at what point do you “adjust” revenue to take out the revenue from value-added activities that do not strictly relate to the production of the crop or livestock product? For instance, if a farmer processes lettuce by washing and bagging the lettuce before sale to a consumer should this limited “processing” be considered adding value to the product and hence be excluded from the coverage level estimation? All of these issues have made application for and AGR-Lite policy paperwork and record keeping intensive for both the farmer and crop insurance agent. While the AGR-lite Wizard tool that NCAT created greatly helps with this paper work and record keeping intensity, as the number of crop and livestock enterprises on a farm expand the more cumbersome the policy application becomes.

One idea for simplifying the current AGR-Lite product could be to base premium estimation only on the actual revenue history of the whole farm by using historical sales records rather than on differing information from varying tax forms and the cumbersome delineation of every crop grown by the farmer. This change could conceivably provide whole farm revenue protection for any level of diversity of production. For example, if a CSA that had a five year average of producing a gross revenue of \$280,000 worth of agricultural products why not simply provide up to 85% of that average gross revenue in its current year’s production without having to provide extensive documentation of each crop? One could even call the product; whole-farm Actual Revenue History Lite (ARH-Lite). The point here is not to narrow the focus of AGR-Lite but rather to explore ways to broaden and simplify it.

**Whole farm revenue insurance (AGR-Lite) should be available nationwide and particularly in larger agricultural states like California where many diverse specialty crop farms that could utilize the product.**

There seems to be no logical reason why the product should not be available in every state. Other than the cost of developing the necessary actuarial data for the states where it is not currently being offered it could easily be made available nationwide. The lack of the availability AGR-lite in such a large agricultural state with many smaller diverse farms like California is a missed opportunity to assist many smaller producers in lowering their risks and improving their profitability.

### **Conclusion**

If increasing the likelihood of a more sustainable agriculture system in the future is a high public priority, then increasing efforts to provide whole-farm revenue-type policies to farmers can assure both an incentive for increased diversity as well as provide an excellent safety net for smaller farmers generally. In principle, whole-farm revenue insurance could be an alternative way to insure not only smaller diverse specialty farms but all crop and livestock production in the country. One key to sustainability is expanding crop and livestock diversity. Whole-farm approaches to insurance such as AGR-Lite will encourage greater diversity in production systems that in the longer-run will likely lead to increased sustainability and profitability.

### **References**

- Diamond, A. and R. Soto, 2009. *Facts on Direct-to-Consumer Marketing: Incorporating Data from the 2007 Census of Agriculture*. United States Department of Agriculture, Agricultural Marketing Service, Marketing Service Division.
- Hoppe, Robert a., James M. MacDonald and Penni Korb, 2010 Small Farms in the United States, Persistence Under Pressure. EIB-63. Economic Research Service. United States Department of Agriculture. [www.ers.usda.gov/publications/eib63/eib63.pdf](http://www.ers.usda.gov/publications/eib63/eib63.pdf)
- Schahczenski, J. *forthcoming*. *Crop Insurance Options for Specialty, Diversified, and Organic Farmers*. NCAT: ATTRA National Sustainable Agriculture Information Service.
- Schahczenski, J. 2011. *Planning for Profit in Sustainable Farming*. NCAT: ATTRA National Sustainable Agriculture Information Service. Available on-line at [www.attra.ncat.org](http://www.attra.ncat.org).

## **Session 2 F**

**Track/Session: Alternative and Traditional Enterprises/Niche Farming**

**Earth Healing with Bamboo – Ecoservices, Bioremediation, Agroforestry**

*Adam Turtle and Sue Turtle, Earth Advocated Research Farm*

## *Earth Healing with Bamboo*

*Adam Turtle and Sue Turtle*

**Bamboo Institute of Tennessee, Summertown, TN**

### *Introduction*

We, collectively, and "over-developed" societies in particular, are no longer living on the "yields" of natural systems. We have disrupted, degraded, and even destroyed many interrelated systems to the point that their essential services are no longer functioning. We are in what may be termed the "Esau Syndrome", that is, we are trading our (and, more importantly, our children's) birthright for a "mess of pottage". We are eating, which is to say -- consuming and/or degrading not only our seed corn, but also the topsoil, the clean water, even the quality of sunlight needed to produce future crops for future generations. We need to somehow disassemble the prevailing colonial paradigm, the Euro-American "success" model. We may try to salvage, in a modified form perhaps, those aspects that are fair and equitable, but we must somehow replace our consumptive and competitive behavior with a more communal and cooperative ideal – our children are at peril. Remember that war is the ultimate competition as well as our most consumptive and polluting act.

"Agroecology," "Agroforestry," "Alternative Energy," "Bioremediation," "Community Supported Agriculture," "Good Stewardship," "Land Reform," "Permaculture," "Plant-a-Row-for-the-Hungry", "Systems Thinking" – these are some of the newer "buzz words" indicating our growing awareness that the status quo ante is not sustainable. Each and all of the above concepts or disciplines have valid contributions to make in our quest for a more equitable and mutually viable future. However, for any or even all of them to truly reverse our social and ecological decline, we must first examine and revise the underlying attitudes and assumptions that led us to our current dilemma. The deadly combination of ignorance and arrogance implicit in our business-as-usual mind- set is increasingly unsupportable. Let us look into our hearts and minds seeking to find a sense of unity, realizing and acknowledging that we are all in this together. Only if so motivated can we build a better future for our children.

That awareness came to me in a vision 42 years ago, and included in that vision was the awareness that all life depends on plants. So I began my research in practical or applied ethnobotany with a focus on warm temperate climatic zones. In the late 70s I became aware that there were temperate as well as tropical bamboos so I began to study whatever literature was then to be found as well as acquiring extensive hardy taxa for field trials in USDA zone 6. In the early 90s, with a new wife and an established "palette" of over 200 species and forms of temperate bamboos representing 20 plus genera, we began use and application trials. Meanwhile we acquired training in ancillary disciplines such as erosion control, integrated pest management, permaculture and soil science that broadened the scope of our investigations.

Thus far, we are persuaded that the bamboos, where climatically suited, possess a larger and more varied suite of benefits, uses, and virtues than any other group of plants as we will seek to demonstrate here briefly.

The Plant

Bamboos are evergreen grasses and native to all continents except Europe, where they were extirpated during a recent ice age. They belong to the supertribe Bambusoideae, which is composed of both herbaceous and woody tribes. We are here concerned with the largest and most widespread tribe, the Bambusae or woody bamboos (members of which can naturally be found from sea level to 4,000 meters), more specifically, select members of the subtribes: Arundinariinae and the closely-related Shibataeinae, which might be termed the hardy or temperate runners. These can vary from ankle high ground covers (many of which have more mass below grade than above) to giant tree grasses of 20 meters or more. Bamboos' natural range is from 50° N. latitude in the Kurile Islands to 47° S. latitude in southern Chile. When introduced, many can semi-naturalize outside their original range in areas receiving at least 75 cm (30 inches) of rain annually. The larger and hardier heat and cold tolerant bamboos are mostly found in genus *Phyllostachys*. Many occur naturally as forest understory and/or as edge species, although most are quite tolerant of full sun. Actual height, diameter, wall thickness, wood quality, and frost tolerance vary with grove age as well as both species and site conditions. These factors need to be carefully matched for successful realization of their potential. The annually updated Species Source List published by the American Bamboo Society on their web site, [www.bamboo.org](http://www.bamboo.org), gives growth parameters, requirements, sources, and some of the uses for nearly 500 bamboo taxa currently available in the United States.

## Growth

Bamboos are the fastest growing plants on earth, up to 1.07 meters in 24 hours. The new shoots in spring emerge at their finished diameter and achieve their full stature in 60 days or less. At first they are soft, made firm only by hydrostatic pressure. They need to stand "on the root" for 5-years to become fully lignified and realize their optimal potential strength. Tropicals, with a longer growing season, mature in 3-years. Immature culms can be used for biomass, pulp, and/or weaving where compressive strength or stiffness are not needed. Multiple use management is possible – (e.g., shoots and poles). Establishment requires 5-10 years before first harvest, depending on end use, but is annual thereafter. Harvest can be culm-by-culm on an annual basis, similar to "high-grading" a forest, or a rotated swath cutting with a mixed age yield requiring hand sorting.

## Benefits, Uses, and Virtues

### Benefits or Services

Bamboos' function in the hydrologic cycle is of great value for future applications since there is essentially no rain runoff from an established grove except in the most torrential downpours. What little does seep out of the grove tends to be clear. Thus, managed bamboo groves minimize erosion as well as providing an ideal ground water recharge cover. Tall bamboos on high ground comb moisture and airborne soil from the atmosphere much as trees do, but bamboos tend to have a greater leaf surface area. On flood plains they slow the water and harvest silt. Their continuous high nutrient leaf drop makes them self-mulching, which quantitatively increases topsoil while improving its water holding ability. Bamboos

accumulate, improve, and protect soils as well as clean the air and raise the water table. And, they can do all this on a diet of municipal or feedlot effluents or any nutritious organic waste, thus providing a truly renewable and sustainable resource base.

Bamboo groves provide habitat for birds, small animals, invertebrates, and fungi ... and a great playground for children of all ages. The ecology of a bamboo grove can be quite diverse. Even large animals will bed or seek shelter in Bamboo. Management strategies, of course, vary with type of bamboo, site conditions, and intended product yield or end use.

## Uses

Bamboo-based cultures have evolved not only in Asia, but also in South America and Africa. The pre-European Indians of the southeastern United States made extensive use of "cane" (*Arundinaria gigantea*) our only native North American bamboo. And Early settlers, where possible, chose canebrakes because they could winter their stock in them; they were easy to clear and once cleared the soil underneath was deep and rich.

What cannot be made with bamboo might provide a shorter list than what can. For instance, symbiotic edible fungi can be cultured in the grove. The new shoots are a nutritious and currently pricey human food at \$3/lb, wholesale and \$4.50/lb, retail. A friend in the Seattle area realized \$35,000-\$45,000 annual return on 5 acres of bamboo managed for shoots – and it is an early spring crop when cash is short. The foliage furnishes a very palatable high-protein feed (up to 22 percent) for any grass-eating livestock which, by the way, must be excluded from growing areas. The cut culms are a good source of pulp for papermaking and can out yield pine 6 to 1. Or they can yield a high BTU biomass for low emission energy generation. Up to 37 long tons per hectare of annual biomass production have been reported. Mature bamboo wood quality is similar to other medium density woods and is superior to pine in strength. When sawn and laminated, bamboo can substitute in many applications. When used in the round, bamboos' unique form and its strength to weight ratio offers many advantages both architecturally and in applications such as piping for use in low cash flow remote areas. When treated with borates in a modified Boucherie treatment, bamboo is resistant to insects as well as fungi. Woven bamboo mat, when impregnated with an organic epoxy and vacuum molded, can assume almost any shape. Strength and weight compare favorably with fiberglass. A high quality cloth has recently been developed from bamboo fiber in China and is available in the U.S. Bamboo can even be substituted for carbon fibers in some applications. Bamboo plywood or "plyboo" as well as bamboo oriented-strand-board and laminated bamboo flooring are now being marketed. When used for durable applications, (e.g.,) furniture, architectural materials, concrete reinforcement, etc., bamboo use can provide significant carbon sequestration. Even when burned for fuel there is a benefit in that it is contemporary carbon rather than fossil carbon that is released.

The United States currently has a tremendous negative balance of trade even as we import over \$50 million a year worth of bamboo poles and products. We also have: massive unemployment, many underutilized or even abandoned small farms, overburdened landfills, organic waste disposal issues from concentrated animal feeding operations and municipalities. We have receding water tables and



diminishing water quality. We have severe soil erosion, material shortfalls, inequitable land distribution, worsening air pollution, etc., etc., etc. Domestic production of bamboo could favorably address many of these interrelated issues; and if given subsidies and incentives similar to the timber and mining industries, a "bamboo industry" could be very economically competitive as well as beneficial on many levels.

World bamboo trade has been estimated at over \$10 billion annually. This is not including domestic or in- country uses that might total as much as an additional \$50 billion. These figures are for use levels almost 10 years ago and do not reflect the potentials possible with new applications from bamboo substitution or new technologies. As a quick- growth, short- cycle feedstock for industrial applications, bamboo is peerless. And, being a high annual yield, short-rotation crop, bamboo could give small farms a renewed vitality and viability.

Besides lessening our "footprint," sensibly grown and utilized bamboo can greatly reduce our dependence on tree wood and to some extent it can substitute for and/or be co-fired with coal. Since bamboos are evergreen (above their species temperature threshold), they photosynthesize year round and should be an ideal feedstock for cellulosic ethanol distillation for fuel production. Bamboos have even been used like mild steel for concrete reinforcement.

## **Virtues**

The seven sages of Chinese lore are said to have valued life in a bamboo grove as it provided the tranquility needed for their contemplations. Part of the explanatory rationale for this lies in the gentle susurration or white noise made by the leaves. In addition to inducing emotional tranquility, a virtue in short supply in our hurried and harried society, bamboo is intellectually stimulating as any child fortunate enough to have played in a grove can attest. There are subtle symbolic attributes. Bamboo is known as "the gentleman", upright but able to bend and always willing to serve. Bamboo is hollow, lightweight and resilient illustrating that mass and rigidity are not the only paths to strength. Its evergreen beauty and calming effect, where known, are appreciated. As a colony organism, bamboos offer a model of mutual support and cooperation, as well as multiple benefits to their "guests" and neighbors. Bamboo's biggest problem seems to be that it is meant to be used. It is not a polite, neglect-tolerant backyard plant.

## **Conclusion**

Acknowledgement of the cumulative negative synergies of our extractive and wasteful practices would insist that we step off the treadmill of unsustainable economic growth that is made possible only by externalizing true costs (i.e., suppression of "others", not cleaning up our mess, etc.). Perhaps then we can jointly and mutually begin an integrated and holistic age of enlightened siblinghood. Toward and within this scenario we believe the temperate bamboos have gifts to offer, lessons to teach, and a prominent role to play. Bamboos contribute needed ecological services. They possess manifold agro-

industrial advantages and have desirable socio-political virtues. And bamboos can do this while providing a soothing and evergreen beauty.

## **Session 2 G**

**Track/Session: Marketing Opportunities/Collaborative Efforts**

### **Exploring Efficiencies in the Merger of the New Generation Growth Cooperative and Farmers' Market to Enhance Vibrant Rural Economies and National Food Security**

*Emmanuel I.S. Ajuzie, Lincoln University, Jefferson City, MO*

### **Exploring Efficiencies in the Merger of the New Generation Growth Cooperative and Farmers' Market to Enhance Vibrant Rural Economies and National Food Security**

**Emmanuel I.S. Ajuzie,**

**Lincoln University, Jefferson City, MO**

#### **Introduction**

Many university educators, Extension specialists, and others have supported all the niche marketing strategies for helping fruits and vegetables producers and farmers in general to sell their produce at a profit. These strategies include: farmers markets, road-side-stands, pick-your-own operations, and community supported agriculture (CSA). Through the USDA Agricultural Marketing Service's Farmers Market Promotion Program, the farmers' market niche has mushroomed all over the nation and has become the main channel for producers to sell directly to the final consumers, thus improving profit margins and avoiding the middleman.

However, as I travel around speaking with farmers, I find that there are many who would like to have additional markets where it would be faster for them to sell their produce, increase profit, and still have the time to participate in other life endeavors, such as taking care of their families and taking their kids to games. Because they have to be present in almost all the niche markets, they find it difficult to participate in these other activities. The limited acreage they have to operate allows them to produce small quantities of fruits and vegetables. Since this is hardly enough to sustain the family's financial needs, small farmers usually undertake off-farm jobs to supplement their family income requirements.

The question then is how do we help our small underserved and socially disadvantaged farmers increase their farm income, enjoy time with their families, and participate in other rewarding activities? Those who operate large farms do not have this dilemma because they have enough volume of fruits and vegetable, or whatever crop they grow, to fill big refrigerated trucks and ship long distances to sell at reasonable profits. They are freed from additional sales responsibilities to focus on growing their produce or indulging in these other additional family activities.

#### **Which Market Is More Efficient?**

From the title of the presentation, it is assumed that there are efficient market issues involved. Markets are efficient mechanisms for distributing resources. In order for this to take place, certain conditions must be met. Information must be widely available, property rights of individuals must be protected, contracts between persons and/or entities must be enforced, there must be very limited or no spillover effect from other actors, and there must be competition (Stone, 2008). If we take information as our example, we can easily see that the market for larger producers tends to be more efficient than the niche markets. Prices offered in the larger markets are quoted at different boards of trade, such as Chicago, meaning that people can easily find the prices for their produce before they ship them for sale. That would encourage the determination of the quantity to ship and how often to ship if the producer can control some factors involved in fruit and vegetable production, such as the perishable nature of produce.

Prices in niche markets are not determined similarly. Producers and consumers usually haggle for prices. The quality and appearance of the produce tend to determine the selling price. The number of persons in the niche market selling similar produce also determines prices paid. Examined from the price information requirement of efficient market, we can say that the markets open to larger producers tend to be more efficient than niche markets.

### **Opportunity Cost**

Another factor that tends to impact efficiency, which is not mentioned above, is opportunity cost. It is the alternative benefit foregone as one undertakes an activity. For example, when one goes to sell at a farmers' market and stays there for approximately 4 hours, the alternative activity he/she could have undertaken is the opportunity cost. If, for example, he/she were to work for those 4 hours and earn an income, that income is the opportunity cost. It is the income forgone as one sells at either the farmers' market, roadside stand, or any of the niche markets. The higher the opportunity cost is, the less incentive there is to continue the current activity unless it has the potential of increasing future income, such as acquiring college education. There is therefore greater opportunity to be more profitable in wider marketplaces than in niche markets (Ajuzie and Swartz, 2012).

Based on the two scenarios, price information and opportunity cost, we can conclude that niche markets are more inefficient than larger marketplaces. However, this type of conclusion does not take into account the fact that small farmers sometimes sell at higher prices in these niche markets. The down side is that they may not sell as much as they would in the wider market place. There is also personal interaction to consider. Some see the farmers' market as a place to get together and mingle with friends and well-wishers, a situation that can add to the wellbeing of individuals.

### **Merging a More Efficient Market with Farmers Market**

Can any good come out of the merger of the farmers' market with the more efficient marketplace? The answer to the question should be positive if we can find a way to help small underserved limited resource farmers gain access to the more efficient wider marketplace. In order for this to occur, small farmers must gain market power whereby they would have enough volume of produce to penetrate the larger marketplace. This could be done by creating marketing cooperatives for these farmers. This is a situation where small, limited-resource farmers produce fruits and vegetables and market them jointly.

Many of these cooperatives have been successfully formed in the past. They lasted for 10 years on the average and discontinued existence. In 1999, Lincoln University Cooperative Extension helped to start one for its clientele. Although the cooperative did very well, by 2005, it ceased to operate due to reasons that plague such organizations. The two most important reasons were: 1) the distribution of revenue from

sales and 2) the lack of adequate management. Because of how well the cooperative did before its dissolution, there was a need to start another one.

In 2010, a cooperative with an umbrella name of New Generation Growth Cooperative (NGGC) was incorporated with the State of Missouri. It was developed by the Agricultural Economics and Marketing Program of Lincoln University of Missouri. Its focus is on organizational perpetuity and longevity, which were lacking in earlier small farmers' cooperatives. Again, it provides the opportunity for small farmers to produce and collectively market for increases in income and profits on few acres of land. Larger marketplaces are contracted to buy from these cooperatives and, like large producers, these buyers take big refrigerated trucks to pick up produce from distribution centers where small farmers collect or pool their fruits and vegetables for shipment. Because of this marketing arrangement and its income generating potential, these small farmers have the incentive to produce more within a given acreage and also expand their operation. These lead to the attraction of new members to the cooperative in record numbers.

NGGC members will still sell their fresh produce in farmers markets. This is quality produce which, because of its bent shape and larger size, does not gain easy acceptance by big merchandize stores. The larger marketplaces are very particular about the specification of the produce they buy. Because of the increase in the quantity of produce grown, there is also bound to be significant increase in the produce that fail to meet specification but are still good quality. It means that there will be substantial increase in the quantity of produce that is taken and sold at farmers' markets.

In recent years, national emphasis has been placed on food security. Defined narrowly, food security refers to the situation when all people at all times have both physical and economic access to sufficient safe and nutritious food that "meets their dietary needs for an active and healthy life". In this age of uncertainties, it also refers to the ability of communities to provide and feed their citizens with healthy locally grown food. The vastly enhanced profitability of NGGC draws many small farmers to it and increases the volume of produce sold at farmers' markets. With a statewide focus of this program, the food security concerns of the State of Missouri will be met with time. More economic opportunities will be generated through entrepreneurial offshoot activities to be created throughout our rural communities. Small farmers will have the opportunity to increase their farm income and quality of life, leading to vibrant communities. The model is transferable to other institutions nation-wide.

## **Conclusion**

There is a misplaced belief that marketing cooperatives will hinder the growth of farmers' markets as the main niche for marketing fruits and vegetables by small producers. We have dismissed that fear by showing that, instead of being in competition with one another; the growth of farmers' markets is indeed enhanced by the existence of strong fruit and vegetable marketing cooperatives. The efficiencies in the larger marketplaces through which marketing cooperatives operate create the opportunity for small farmers to make more profit and produce more fruits and vegetables. The increase in production leads to greater quantities of fruits and vegetables that fail to meet larger marketplace specifications for merchandizing. Given that they are still good quality fruits and vegetables, they are taken to farmers' markets where they increase the quantity sold.

Meeting the food security requirements of the U.S. would take more than producing for farmers' markets. Despite the rate at which farmers' markets are growing, consumers still go in droves to our large grocery stores to buy fruits and vegetables. To verify this, all one needs to do is go into stores, such as Wal Mart, and watch carts loaded with food items. Most of these fruits and vegetables come from places outside the United States. Food safety means finding ways to flood these grocery stores with our locally grown healthy fruits and vegetables. This investigation shows that the harmonious collaboration between

farmers' markets and marketing cooperatives promises to be a creative vehicle that would help us to meet the food safety need of satisfactorily feeding our people with nutritious locally grown fruits and vegetables to meet their dietary needs.

#### Reference

- Ajuzie, Emmanuel I.S. and Helen Swartz. (2012). "Economics and Marketing of Lamb and Wool: The Case of Missouri" *The Banner Sheep Magazine*, 34(9):196-198
- Stone, Gerald W., *Core Economics* New York, NY: Worth Publishers, 14 Madison Avenue, New York, NY 2008.

## Session 2 H

### **Track/Session: Outreach to Underserved Communities/New and Beginning Farmers Part II**

#### **Using Business Plans to Empower Women Who Manage Horticultural Businesses in New Jersey and Turkey**

*Burhan Özkan, Akdeniz University, Antalya, Turkey, and Robin G. Brumfield, Jenny Carleo, Stephen J. Komar, April Lippet-Faczak, Jennifer Matthews, Meredith Melendez, Robert Mickel, Barbara O'Neill, and Nicholas Polanin, Rutgers, the State University of New Jersey, New Brunswick, NJ*

#### **Using Business Plans to Empower Women Who Manage Horticultural Businesses in New Jersey and Turkey**

**Burhan Özkan**

**Akdeniz University, Antalya, Turkey**

**and**

**Robin G. Brumfield, Jenny Carleo, Stephen J. Komar, April Lippet-Faczak, Jennifer Matthews, Meredith Melendez, Robert Mickel, Barbara O'Neill, and Nicholas Polanin**

**Rutgers, the State University of New Jersey, New Brunswick, NJ**

#### **Annie's Project in New Jersey, USA**

Twenty-two percent of New Jersey's 10,327 farms have a female principal operator as compared to 14 percent nationally (National Agricultural Statistics Service, 2010). As the number of women farmers in the United States continues to grow, Annie's Project successfully provides a comprehensive educational program and support network for women farmers by focusing on farm and family financial management, legal aspects of farming, marketing, managing human resources, and production planning.

(McKinney, 2012). The Rutgers Cooperative Extension team has offered farm business management programming to over 130 women farmers and business owners in New Jersey via Annie's Project beginning in February 2011.

Annie's Project New Jersey differs from Annie's Project in other states in five key areas: 1) the focus on creating a farm business plan throughout the training, 2) the use of social media education and adoption for marketing and business development, 3) the use of social media tools to assist the participants in networking that is sustainable and interactive, 4) using a unique combination of in-person education and distance learning opportunities to expand the audience within the program, and 5) recording the distance learning sessions for asynchronous education of participants and additional women farmers following the completion of the "live" course.

Innovations to Annie's Project New Jersey programs were the result of two focus groups that the project team conducted in late 2010 to inform the content of Annie's Project workshops and, in 2012, from reviewing evaluations from the three first year classes in 2011. While Annie's Project originated in the Mid-west where agronomic crops are the primary agricultural crops, New Jersey is the most densely populated state in the United States with higher land and labor costs and more regulations than other states. On the flip side, the state's comparative advantage over other states is that it has a higher percentage of high-income consumers. Thus, successful farmers in New Jersey are often horticultural producers and many are direct marketers; they need to produce high value crops and products to succeed in agriculture in New Jersey. With New Jersey farmers working in such a competitive environment, the project team decided that it would require every Annie's Project New Jersey program participant to complete a business plan.

We held Annie's Project New Jersey workshops for 3 hours one evening per week for seven consecutive weeks because many female farmers often had off-farm jobs during the day, or they were busy managing their farms during the day. We organized the workshops and topics around the five areas of farm risk identified by the United States Department of Agriculture (USDA): production, marketing, financial, legal, and human risk and tied these risk areas to different components of the business plan that participants were encouraged to complete. Each week, we gave program participants a section of their business plan to complete as their homework assignment. The next week, they shared these with other participants, and received feedback and encouragement. They used the University of Minnesota online business planning tool, AgPlan(2010), and project team members followed their progress on-line once they were selected by participants as reviewers.

A key component of the program was women networking with other women in the workshop and sharing ideas. (McKinney, 2012). Because over 40 percent of farmers in New Jersey are engaged in agritourism, the program had a strong focus on marketing, and included topics on social media as a marketing tool. In addition, the project team used Facebook™ (<http://www.facebook.com/Annie's-Project-NJ>) and Twitter™ (hash-tag #apnj) where Annie's Project New Jersey participants can network with each other.

The first year, we offered courses in three locations in New Jersey: South Jersey (Cape May Court House), North Jersey (Hackettstown), and Central Jersey (Bridgewater). Using an extraordinary combination of in-person education and distance learning via the Blackboard Collaborate™ platform, in 2012, Annie's Project New Jersey trained three more groups of women across the Garden State: Cumberland County (Bridgeton), Somerset County (Bridgewater), and Burlington County (Bordentown). We broadcasted and recorded the live sessions each week, allowing women to watch a lecturer from over 100 miles away. Once the 'live' course was completed, we posted edited videos and

the speakers' handouts on the Rutgers Farm Management website (<http://aesop.rutgers.edu/~farmmgmt/anniesproject.html>) as an on-going resource for Annie's Project New Jersey graduates as well as others who wish to broaden their knowledge on a specific topic, or learn something new about successful agricultural business management. The almost two dozen speakers included project team members, professors from Rutgers University, and farm industry professionals. The "live" location rotated among the three sites each week. Each site had a local facilitator who was responsible for local promotion, registration, course facilitation, including homework review, evaluation, and networking facilitation. The participants were encouraged to share how they have managed each issue lead by the site coordinator and homework was reviewed for the first 20 minutes of each session.

### **Suzanne's Project in Turkey**

In August 2011, Rutgers, the State University of New Jersey, and Akdeniz University in Antalya, Turkey formed a team with the goal of adapting the Annie's Project model to train Turkish women farmers on the best practices and basic skills necessary for them to sustain profitable agricultural businesses. The Antalya region was the focus as this Mediterranean region generates 33 percent of Turkey's agricultural exports and 50.9 percent of Turkey's greenhouse production (Yilmaz et al., 2005). Antalya is the main tourism region in the country, and off-farm opportunities are available; but, greenhouse production demanding a large labor force provides substantial employment opportunities. Women in Turkey have important roles in the agricultural sector, but they are less literate than men and they are also paid less in agricultural jobs compared to men (Uysal-Kolasin and Guner, 2010; Ediz, 1998). Furthermore, women farmers do not have as much access to agricultural resources including Extension services, credit, inputs, and productive assets as their male counterparts do, limiting their own progress in professional skills and societal status (Klaver and Kamphuis, 2006).

*Suzanne's Project* is aimed at helping Turkish women smallholder farmers develop technical, entrepreneurial and managerial skills through specialized training. The mission is to help realize their full-potential to operate and sustain profitable farms as small businesses and to gain self-confidence.

The Extension service in Turkey is not part of the university system as it is in the United States (Ozcatalbas et al., 2004). This makes knowledge transfer to women (and men) farmers difficult. Partners at Akdeniz University worked with Extension educators at Turkish Ministry of Food, Agriculture, and Livestock (MINFAL) which also includes the Turkish Extension Service to conduct a needs assessment and feasibility study to determine the scope and course content of the project. We interviewed Extension educators and women farmers in the villages of Elmali, Kumluca, and Korkuteli, and used the results to develop a pilot 28-hour course to train 40 women from small-scale citrus and greenhouse farms in Kumluca, Turkey from October 24 to November 18, 2011. The training included hands-on instruction in computer literacy, instruction in the technical aspects of citrus and greenhouse production, and business management topics. Technical topics included greenhouse construction and ventilation, soil productivity and plant nutrition, pesticide safety, plant protection and biological insect and disease control, sustainable production, and protection of soil and water resources. The business management topics were structured around developing a business plan using worksheets. As in New Jersey, the first 20 minutes of each class was spent reviewing their business plans. This networking helped build a sense of community and empowered the women as they gained confidence in sharing their plans and in helping each other develop their business plans. We created a Facebook page to post information and for participants to network with each other: (<http://www.facebook.com/Suzannes-Project>) as well as a website: ([http://aesop.rutgers.edu/~farmmgmt/suzannes\\_project.html](http://aesop.rutgers.edu/~farmmgmt/suzannes_project.html)).

As a result of the success of the first Turkish Suzanne's Project pilot, the municipality of Elmali funded a second pilot from February 16 to March 6, 2012 to train 20 more Turkish women farmers. Duzce University partnered with Akdeniz and Rutgers Universities to offer a workshop from September 23 to October 5, 2012 in Cilimli, Turkey.



**Table 1. Baseline characteristics of women farmers in the first class on risk management education held in New Jersey and Turkey in 2011.**

Item	Turkey	New Jersey
Number of respondents	40	30
Demographics		
Age	38.4	48.4
Marital Status		
Married	86.6%	80.0%
Single	12.8%	10.0%
Widowed	2.6%	3.3%
Divorced	0.0%	6.7%
Average Family Size - (Number of people)	4.3	3.7
Average Years Farming	18.7	13.5
Characteristics of the farms at the beginning of the course		
Gross Farm Income		
Under \$50,000	65.8%	63.3%
\$50,000-\$150,000	29.0%	6.7%
\$150,000-\$300,000	0.0%	6.7%
Over \$300,000	5.5%	6.7%
No Answer	0.0%	16.7%
Average size of farm		
Hectares	5.3	38.0
Acres	13.1	94.0
Percentage who carry crop insurance	20.5%	20.0%
Percentage who grow some crops under contract	13.2%	0%

As is illustrated in Table 1 many similarities exist between the two groups. The most striking differences are average age. The American producers' average age was 10 years more than the average age of the Turkish producers. Another notable difference is the average acreage or number of hectares farmed by the producers. American producers enrolled in Annie's Project New Jersey on average farmed 94 acres (38 hectares) versus their Turkish counterparts who farmed an average of 13.1 acres (5.3 hectares).

Table 2 illustrates the percentages of women who had positive attitudes and actions towards completing the various portions of a business plan. Annie’s Project graduates have used their business plans to add new enterprises, secure farm loans, and develop websites, Facebook pages, and point-of-purchase materials for their farms. It is possible that the reason a larger percentage of the Turkish women completed the more detailed portions of their business plans was due to the use of the unpublished workbook developed specifically for the Turkish producers. In future Annie’s Project New Jersey classes we will use a workbook adapted from the original one to American conditions.

**Table 2. Percentage of participants who completed, are in the process, or plan to complete sections of their business plans as a result of the 2012 courses.**

	Done prior to course	Do not plan to finish	Plan to finish	In process	Complete	Done prior to course	Do not plan to finish	Plan to finish	In Process	Complete
Components	Turkey					New Jersey				
Mission Statement	6%	0%	0%	0%	94%	4%	0%	2%	19%	76%
Goals	0%	0%	0%	11%	89%	0%	0%	4%	35%	62%
Farm Description	0%	0%	0%	0%	100%	4%	0%	6%	27%	64%
Production Plan	0%	0%	0%	0%	100%	2%	4%	24%	43%	28%
Marketing Plan	6%	0%	0%	0%	94%	0%	4%	20%	54%	22%
Financial Plan	0%	0%	39%	11%	50%	4%	2%	22%	61%	10%
Exec. Summary	0%	0%	0%	94%	6%	2%	8%	29%	39%	23%
Management Plan	0%	22%	6%	33%	28%	2%	4%	28%	45%	21%
Estate Plan	0%	67%	6%	6%	6%	10%	10%	44%	20%	16%

*Funding for Annie’s Project in New Jersey is provided by the Northeast Center for Risk Management Education, the USDA’s National Institute of Food and Agriculture Risk Management Agency, Farm Credit East, and Rutgers Cooperative Extension. Cooperating agencies include Rutgers, The State University of New Jersey; USDA; USDA’s Farm Service Agency; New Jersey Farm Bureau; New Jersey Department of Agriculture; and county Boards of Chosen Freeholders. In-kind support for*

*Suzanne's Project was provided by Akdeniz University, Rutgers Cooperative Extension, Antalya Provincial Directorate Food, Agriculture and Livestock, REEF Reports, the villages of Kumluca and Elmali, Duzce University and TOBB Association of Women Entrepreneurs.*

## **References**

Center for Farm Financial Management. (2010). *AgPlan*. University of Minnesota.  
<<https://www.agplan.umn.edu/>>

Ediz, D. (1998). "Enhancing women's participation in agricultural development: Turkish case".  
Research Report.

Ozcatalbas, O., R.G. Brumfield, and B. Özkan, B. (2004). The Agricultural Information System for  
Farmers in Turkey, *Information Development*, 20(2):97-105.

Klaver, D. and B. Kamphuis, B. (2006). *Horticultural Education and Extension in Turkey, Wageningen*.  
<[http://www.lei.wur.nl/NR/rdonlyres/919F1FCA-7748-434A-B8A7-E15E5A4841B5/41460/Turkey\\_Extension\\_Education\\_report4.pdf](http://www.lei.wur.nl/NR/rdonlyres/919F1FCA-7748-434A-B8A7-E15E5A4841B5/41460/Turkey_Extension_Education_report4.pdf)>.

McKinney, L. (2012). *Annie's Project Website*. Iowa State University Extension.  
<<http://www.extension.iastate.edu/annie/>>

National Agricultural Statistics Service. (2010). *2007 Census of Agriculture for New Jersey*.  
<[http://www.agcensus.usda.gov/Publications/2007/Full\\_Report/Census\\_by\\_State/New\\_Jersey/](http://www.agcensus.usda.gov/Publications/2007/Full_Report/Census_by_State/New_Jersey/)>

Uysal-Kolasin, G. and D. Guner, D. (2010) 4 million 742 thousand women are illiterate. Bahçeşehir  
University. Research Brief No. 085, August 19, 2010.

Yilmaz, I., C. Sayin, and B. Özkan (2005). Turkish greenhouse industry: past, present, and future.  
*New Zealand Journal of Crop and Horticultural Science*, 33: 233-240.

## **Session 2 I**

**Track/Session: Programming Planning and Implementation/Managing Agricultural Risks Part II**

## **Growing Farms Online: Comprehensive Education for Beginning Farmers and Ranchers in an Online Environment**

*Garry Stephenson, Melissa Fery, Amy Garrett, Melissa Matthewson, Kristin Pool, Nick Andrews, and Maud Powell, Oregon State University Small Farms Program, Corvallis, OR*

### **Growing Farms Online: Comprehensive Education for Beginning Farmers and Ranchers in an Online Environment**

**Garry Stephenson, Melissa Fery, Amy Garrett, Melissa Matthewson, Kristin Pool, Nick Andrews, and Maud Powell, Oregon State University Small Farms Program, Corvallis, OR**

#### **Introduction**

As current farmers and ranchers enter retirement age, a significant number of farms and ranches and an extraordinary amount of farmland will change hands. Fostering the next generation of farmers and ranchers will require specialized instruction and infrastructure. There are two challenges we face in Oregon that are likely shared with other states:

1. There are numerous beginning farmers and ranchers with geographic, service, and other barriers to accessing intensive face-to-face educational programs.
2. In light of decreasing or stagnant budgets, how do we create sustainable beginning farmer education consistent with staffing that lasts beyond the life of a grant?

#### **Beginning Farmer and Rancher Education should be Accessible**

In Oregon, the landscape and distribution of beginning farmers and ranchers is problematic. Population density varies widely, and geography, distance, and driving time can be an impediment for farmers and ranchers to access educational programs. For instance, the Oregon State University (OSU) Small Farms Program has delivered its 8- week face-to-face beginning farmer and rancher workshop series, *Growing Farms: Successful Whole Farm Management*, since 2007. Although the workshops are highly effective, they are limited logistically to several sites per year consistent with staffing service areas and budgets.

#### **Education providers need resources that are practical for budgets and staffing**

Resources for Extension education and non-profit outreach have declined over time. Almost two decades ago, Campbell (1995:73) noted the difficult challenge of “expanding the reach, quality, and effectiveness of instruction within the context of shrinking resources.” Others point out as education

providers continue to face shrinking resources, distance education is vital to the effectiveness and accessibility of its programs (Dromgoole and Boleman, 2006).

Creating multiple delivery options—including online courses—is an essential strategy to provide education to enhance the success of beginning farmers and ranchers that is practical for budgets and staffing and sustainable in terms of longevity.

### **Online education is effective**

Use of the internet for education is exploding. One recent study estimates that over 6 million college students were enrolled in an online course. This means nearly one-third of all students in higher education are taking at least one online course (Allen and Seaman, 2011). Online education is not just for college students. Other areas of outreach to agricultural producers are becoming more dependent on internet delivery. The *eXtension* network is a chief example. There are a growing number of non-credit online courses related to agriculture offered by universities and agencies. For example, an outgrowth of the Northeast New Farmer Network project Cornell University's Beginning Farmer Project currently offers online courses for beginning farmers. Other examples include: SARE Strategic Farm/Ranch Planning and Marketing Courses and AgriLIFE Extension of Texas A & M University.

### **Beginning Farmers and Ranchers are Technologically Ready**

Beginning farmers are described as “market wise, tech savvy” (Duffy, 2009). In addition, a survey of young farmers and ranchers (18-35 years of age) by the American Farm Bureau (2010) revealed that 99 percent have access to the internet; 80 percent have high speed or satellite access; 75 percent use social media sites; 10 percent micro-blog using Twitter. Age is not an issue for use of the internet. A 2006 Gallup poll showed no significant difference in use of the Internet based on age until over 70 years (Joseph, 2006). These statistics and the trend they reveal cannot be ignored. Education in the form of online courses is within the capability of beginning farmers and ranchers and is the most efficient way to reach remote audiences.

### **Converting the face to face *Growing Farms* workshops to *Growing Farms Online***

*Growing Farms Online* converts and expands Oregon's highly successful workshop series *Growing Farms: Successful Whole Farm Management* and includes several ground-breaking features. The course fosters holistic planning by integrating the physical, biological, family, and business components of farms and ranches. The course contains six modules that are fully online and capable of multiple modes of delivery including hybrid or blended online/face-to-face options, and self-guided and self-paced.

Content areas for *Growing Farms* have been refined in workshops since 2007. The curricular framework and titles are:

- **Dream It: Strategic Planning.** Defining family and farm values and assets to build a strong farm plan. Includes assessing soil and water capabilities to assist cropping system planning.
- **Do It: Farm Operations.** Planning for human and mechanical farm/ranch infrastructure, including matching efficient farm equipment and renewable energy options with the production system, the role of the family in providing necessary farm/ranch business skills and labor, and managing farm/ranch infrastructure for a successful production system.
- **Grow It: Production.** Managing the biological segment of the farm/ranch with the essentials of agro-ecology for annual and perennial cropping and livestock systems. Strategies to manage soil health, conservation biological control, and other approaches.
- **Manage It: Farm Finances.** Implementing sound financial planning for a successful business, including record keeping, production cost, and farm/ranch business structures.
- **Sell It: Marketing Strategies.** Planning for an array of wholesale and direct farm/ranch marketing options and the connection between crop production decisions and marketing channel decisions.
- **Keep It: Managing Risk.** Planning for sustaining the new farm or ranch, including integrating various risk management tools such as liability and crop insurance, licenses and entrepreneurship, and succession planning.

The process of converting content delivered face-to-face into a form for effective delivery online is challenging and time consuming. A group of faculty associated with the OSU's Small Farms Program has been producing the modules through forming topical production teams and working closely with an online curriculum specialist. Four of the six modules have been completed, and the project just completed its second year. The Project is also working closely with OSU's Professional and Non-Credit Education segment of *Ecampus*.

The online format uses a framework that accounts for different levels of motivation and education within our farmer and rancher audience, and also distinguishes content appropriate for an online course versus face-to-face activities that can provide greater depth, hands-on learning experiences, and interaction for use in hybrid delivery. The course utilizes high standards for navigation, learning objectives, assessments, instructional materials, learning activities, technical support, and ADA requirements. Developments in online learning technology now make it possible to create and deliver a very high quality educational product, one that is graphically rich, engaging, and that offers the opportunity for thought, reflection, action and further study.

Each online module consists of:

- Curriculum outline, goals, and learner objectives
- Educational content, including exercises, narrated presentations, video segments of farmer case studies, text based materials, and additional online and text references
- Optional assignments
- Optional quizzes with instant answer key and feedback

- Self-evaluation of learning
- Course evaluation form

### **Post-course resources to enhance success**

A crucial component to implementation of new concepts or technology is providing infrastructure for participants throughout the process (Brown, 1981). This project includes several important post-course resources to enhance the success of course participants. Incorporated into the course is training for use of Ecotrust's *FoodHub* a cutting edge low risk online marketing tool. Additional support and resource infrastructure are integrated into the course through electronic and face-to-face communities of practice.

### **Modes of Delivery**

For farmers and ranchers in areas easily served by face-to-face educational programs, a blended or hybrid online and face-to-face approach will be the preferred method of delivery. The approach decreases the number of face-to-face meetings (thus, decreasing staff commitments from 8 weeks to 3 or 4 weeks). In this instance, participants will use the online course for basic learning while face-to-face meetings will be used for discussions and hands-on learning during farm tours offer additional education and experience. For farmers and ranchers in regions lacking the critical mass for face-to-face educational programs, the course may be taken in a standard online format supported and facilitated by instructor(s). Some farmers and ranchers may prefer to take the course as unsupported self-directed study.

### **Impacts**

As with the face-to-face approach to this course, the online option will facilitate useful whole farm plans, improved decision making, effective marketing, and ecologically sound farming practices. With an emphasis on production of high value crops and value added processing on small and medium farms and ranches for local and regional markets, the course develops farms and ranches of this type and scale improving individual farm and ranch profitability. In addition, increased establishment of these farms and ranches counters the trend toward consolidation in agriculture and food processing, and develops the economy of rural as well as peri-urban and urban communities.

The project is supported by a USDA/NIFA Beginning Farmer and Rancher Development Program grant, and is a powerful partnership between non-profits Ecotrust, Mercy Corps Northwest and Oregon Tilth and Oregon State University's Small Farms Program and Austin Family Business Program.

### **References**

Allen, I. E. and Seaman, J. (2011). *Going the Distance Online Education in the United States*. Needham, MA: The Sloan Consortium.

American Farm Bureau. (2010). "Young Farmers and Ranchers Concerned but Express Optimism". American Farm Bureau (online), [Retrieved March 10, 2012].

Brown, L. A. (1981). *Innovation Diffusion: A New Perspective*. New York, NY: Methuen.

Campbell, J. R. (1995). *Reclaiming a Lost Heritage*. Ames, IA: Iowa State University Press.

Dromgoole, D., and Boleman, C. (2006). "Distance Education: Perceived Barriers and Opportunities Related to Extension Program Delivery." *Journal of Extension* [online], 44(5).

Duffy, M. P. (2009). "The Next Generation of Farmers, Young, Landless and Savvy". *The Journal of Northeast Agriculture*. 12 (2):6-11.

Joseph, C. (2006). "Internet Catches More American's Time". <http://www.gallup.com> [Retrieved January 10, 2006].

### **Education Webinar Enhancement**

**Mark Kepler**, Agriculture, Fulton County, **Steve Engleking**, Purdue University, LaGrange County



## **Educational Webinar Enhancement**

**Mark Kepler, Agriculture Extension Educator, Fulton County, Rochester, IN**

**Steve Engleking, Agriculture Extension Educator, LaGrange, County, Rochester, IN**

The Purdue University Small Farms Team has launched several programs via webinars and in person presentations to help small and beginning farmers. Several of these efforts have been geared to livestock farmers. Programs have been geared specifically to those involved or contemplating the meat goat industry.

In 2010 and 2011, a series of goat and sheep applicable webinars was produced. These programs utilized speakers from the following universities: Purdue, Kentucky State, Kentucky, and Iowa State. These series covered a variety of topics, including coccidiosis, parasites, foot rot, feeding, marketing, disease prevention and forages. These programs were available exclusively on Extension sites across Indiana and Kentucky.

Evaluation of these programs, done by surveying the participants, revealed very positive feedback for most of the presentations. A typical evaluation parameter response can be seen in one of our impact statements: Those surveyed indicated that after participating in the program they would be better able to diagnose and treat medical problems in their herds, 94 percent and increase the productivity and profitability of their herd, 93 percent.

However, one of the greatest changes is anticipating the outside factors that can ruin a presentation. Consistent negative comments were made about the audio/visual quality of the presentations. These factors could be blamed on both the speakers' unfamiliarity with this type of presentation and network problems.

With this in mind, a white paper was produced to enhance presentation performance of those who intend to use webinars for presentations.

### **Effective Webinars**

Webinars can be an effective way of communicating Extension activities to a large number of targeted audiences. We need to use effective means to utilizing this method to give these audiences the fullest educational information possible.

The following are some ways to enhance performance when using webinars.

1. Teach like you want to be taught. Do you want to sit for an hour listening to a monotone voice with endless slides of writing and no pictures? Be excited about what you teach. Capture some video ahead of time and incorporate it. Stay away from slides that are too colorful.
2. Never make excuses. Starting a program with an excuse only serves to lower the expectations of your audience. Do not say, "I have never done one of these before and this is not my preferred method."
3. Get some good equipment for broadcast. Excellent programs can be ruined by poor equipment. A quality microphone or head set that has been tested ahead of the program is best. If you use a microphone make sure it is on a stationary stand. Use ear buds with it to test compatibility. Check sound

levels ahead of time. Broadcast from the same equipment you have tested. Do not switch. Do not use wireless technology. Stay with the hard-wired. Some have a tendency to over project their voice and this causes a sound problem called clipping, making the voice sound choppy.

A good quality microphone is a Blue Snowball for around \$70. An excellent head set is a Plantronics Audio 550 DSP Ultimate Performance Headset for about \$60.

4. Learn how to use the webinar program so you know the proper methods of pointing and advancing the slides.
5. Have someone on hand to back you up on the technical problems. While you are presenting another person needs to be dealing technical problems. Keep your mind on the program.
6. Have a host or moderator. This person can be looking at the questions coming in and assemble multiple similar questions into one. That person can also eliminate poor questions or ones that are not on subject.
7. Wait till the end of your program to answer questions. These programs have an allotted time frame and you need to make sure that you have presented all of your information. Use your host.
8. At the end of your program and when it is time to take questions, a host will be interacting with you. Make sure you have turned on your speakers to hear them. You speakers should be off during the program to prevent feedback. Using a head set will allow you to hear without feedback.
9. Have presentation materials done a week ahead of time. There are a lot of reception sites that need to hand this material out to their audience. They need to have time for their staff to assemble this material.
10. Rehearse several days ahead. This will allow you to determine if you have equipment problems.
11. If you are presenting in a room with people, keep yourself focused on the microphone. In this situation a head set will follow your head and may be the best option over a stationary microphone.
12. This webinar is being done over Adobe Connect. Take some time to go through it to enhance your program.

Purdue Cooperative Extension Service—Fulton County

1009 West Third Street

Rochester, IN 46975 Phone: 574-223-3397

[www.ag.purdue.edu/counties/fulton](http://www.ag.purdue.edu/counties/fulton)

## **Session 2 J**

**Track/Session: Research and Extension Priorities/Enhancing Farm Opportunities**

## **Emerging Opportunities to Enhance Small Farm Viability in the Northeast**

*Anu Rangarajan, Violet Stone, Matthew Goldfarb, Erica Frenay, and Michelle Podolec, Cornell Small Farm Program, Cornell University, Ithaca, NY*

### **Emerging Opportunities to Enhance Small Farm Viability in the Northeast**

**Anu Rangarajan, Violet Stone, Matthew Goldfarb, Erica Frenay, and Michelle Podolec**

**Cornell Small Farm Program, Cornell University, Ithaca, NY**

## **Introduction**

In 2006, the Cornell Small Farm Program initiated a biannual New York (NY) Small Farm Summit to identify priorities for enhancing the viability of small farms in the state. At this first summit, the following priorities were put forth:

1. Marketing innovations to connect consumers with local and regional producers
2. Renewable energy technologies, energy crops, and energy conservation
3. Enhanced utilization of grasslands resources for economic development and environmental protection
4. Integrated farming systems using appropriate technologies
5. Improved processing regulations, infrastructure and technologies for small farm meat and dairy products
6. Beginning farmer support

In response, the Small Farms Program, with federal Smith-Lever and other state funds, supported five work teams to create strategic plans for each area. Each team identified key next steps to strengthen support for small farms in these areas. The teams were supported for 4 years, with the goal of creating improved networks and resources to support these five opportunity areas.

## **The 2012 NY Small Farm Summit**

In 2012, we hosted our fourth Small Farm Summit, with the goal of reviewing and updating the priorities. To expand the participation of farmers from around New York, we issued an online survey prior to the Summit. This survey was shared with our Small Farms mailing list (about 5,000 members). Individuals identified themselves as farmers, educators or community members. The respondents were asked to prioritize from a list of 16 items framed as “Opportunities to Enhance Small Farm Viability.” The list was generated based upon the efforts of 5 small farm work teams that had been conducting research and education in the state. Respondents were asked to choose only five items as high priority, and otherwise choose medium or low. We asked survey participants to take the “bird’s eye” view, and

consider how they would prioritize investment not only for their own farm or business, but also for their community and colleagues.

Of the 573 respondents to the survey, 92 percent were from New York, 59 percent were farmers, 18 percent were aspiring farmers, 16 percent were agricultural educators/service providers, and 7 percent were community members. Respondents provided county of residence, which allowed us to provide customized reports by New York region to reflect differences in agricultural enterprises, climate and other agricultural resources.

At the 2012 New York Small Farm Summit, 160 diverse stakeholders gathered in one of five possible regional locations. The summit was facilitated via videoconference, to reduce travel time and increase participation by small dairy producers and others who worked off the farm. These participants reviewed the survey results, and then clarified measurable outcomes that could be achieved within 2 years for the top six opportunities as ranked in the survey. Below is a summary of the top 5 priorities, as well as the full list (in rank order) of 16 opportunities to enhance small farm viability.

The Small Farm Summit has been a very effective method to identify statewide initiatives as well as build regional networking and collaboration to enhance small farm viability. The summit is unique in New York, as one focused strictly on small farms. By videoconferencing, we minimized the costs associated with travel to the conference, while facilitating regional networking and team building among educators and farmers. The videoconference format has also allowed us to include presentations from Cornell Deans and researchers, the Commission of Agriculture for New York and other regional Cooperative Extension educators and farmers. Individuals are able to share stories, results and experiences with a very diverse, and geographically spread audience.

Video from the 2012 Summit as well as more detail on the survey outcomes can be found at: <http://smallfarms.cornell.edu/projects/summit/> For more information on the Cornell Small Farm Program: please visit: <http://smallfarms.cornell.edu/> For additional resources from our project targeting Beginning Farmers, please visit: <http://nebeginningfarmers.org/>

### **What can Cornell and Cooperative Extension do to support the viability of small farms?**

The following is a summary of the top five statewide priorities selected by an audience of over 500 survey respondents and an additional 160 farmers, agriculture service providers, policy makers and other small farm supporters present at the 2012 New York Small Farms Summit. The Cornell Small Farms Program hosted the summit on February 29th, 2012, to evaluate emerging opportunities and prioritize investments to enhance the viability of small farms in New York. Example activities are also provided.

1. Develop FOOD DISTRIBUTION STRATEGIES (e.g., collaborative marketing, product pooling and trucking, food hubs) to expand small farm access to local and regional markets: Researchers, Extension, and economic developers need to identify bottlenecks in local and regional food purchasing and distribution, and create and evaluate strategies that increase farmer/distributor/ customer connections. Extension needs to provide support and education for new distributor businesses and farmer networks to increase the likelihood of long-term success.

2. DOCUMENT ECONOMIC IMPACT OF SMALL FARMS on their communities to increase investment in and support of small farm: Researchers, farmers, and Extension need to collaborate with

local communities in developing methodologies and measurements of small farm economic impact to inform future investment decisions at the county, regional, and state levels.

3. Develop new and/or expand existing **LIVESTOCK PROCESSING FACILITIES**: Technical schools, colleges, and Extension need to offer a variety of educational programs on how to open and manage small-scale slaughter and processing facilities and how producers and processors can work more effectively together. Rules/regulations for small producers/processors need to be clarified, streamlined, and scaled appropriately to serve the growing local meat industry.

4. Identify **ALTERNATIVE FINANCING STRATEGIES** accessible to small farms: Extension needs to collaborate with agricultural funders and banks to provide educational programs, materials and guidance to assist small farmers in navigating sources for traditional loans, such as banks, USDA-Farm Service Agency and non-traditional sources such as community investment funds (i.e., slow food) and venture capitalists.

5. Advocate for **GREATER INVESTMENT IN SMALL FARM SERVICES** (i.e., research, Extension and education): Researchers and Extension need to develop new techniques for more efficient small-scale production and marketing. Cornell should take a leading role in research and education on rebuilding the local food economy and economic issues that impact agriculture and distribution. Farmers are losing access to critical information because of defunding Extension services. Increasing funding for Extension will bring back critical services and result in increased farmer viability.

New York Statewide Priorities to Enhance Viability of Small Farms (in order of importance)

- 1) Develop **FOOD DISTRIBUTION STRATEGIES** (e.g., collaborative marketing, product pooling and trucking, food hubs) to expand small farm access to local and regional markets;
- 2) **DOCUMENT ECONOMIC IMPACT OF SMALL FARMS** on their communities to increase investment in and support of small farms;
- 3) Develop new and/or expand existing **LIVESTOCK PROCESSING FACILITIES**;
- 4) Identify **ALTERNATIVE FINANCING STRATEGIES** accessible to small farms;
- 5) Advocate **GREATER INVESTMENT IN SMALL FARM SERVICES** (i.e., research, Extension and education)
- 6) Develop and promote affordable **ENERGY, CONSERVATION, AND RENEWABLE ENERGY SOURCES** for small farms
- 7) Evaluate **LIVESTOCK PROCESSING REGULATIONS AND POLICY** for impact on small farms;
- 8) Evaluate and promote profitable **VALUE-ADDED PROCESSING OF MILK** (e.g., yogurt, cheese) to expand market opportunities for small dairies;

- 9) Conduct trainings on ALTERNATIVE LIVESTOCK PRODUCTION AND MARKETING STRATEGIES to overcome processing bottlenecks;
- 10) Develop strategies to expand on AGRICULTURAL LAND ACCESS
- 11) Expand GRAZING EDUCATION AND RESEARCH;
- 12) Recruit YOUTH, MINORITIES, AND MILITARY VETERANS into farming;
- 13) Expand SUPPORT FOR SMALL FARMS PRODUCING IN URBAN AREAS;
- 14) Conduct research and education on FOOD SAFETY RISKS of small farms;
- 15) Expand production and processing of LOCAL BIOMASS AND BIOFUELS for small farm; and
- 16) Identify novel technologies/practices to improve viability of SMALL DAIRY MILK PRODUCTION.

### **Additional Emerging Opportunities**

The following emerging opportunities were suggested by participants at the Small Farm Summit as critical to success

- .Develop REGIONAL FOOD PROCESSING FACILITIES for small producers
- Address TAX ISSUES for small farms
- Address SMALL FARM INSURANCE/RISK MANAGEMENT
- Address LABOR CONCERNS ON SMALL FARMS

Explore strategies for IMPROVING ACCESS TO AGRICULTURAL INPUTS

### **Soil Sampling to Direct Farm Management on Diverse Organic Farms**

*Doug Collins, Craig Cogger and Andy Bary, Washington State University*

### **Tillage Reduction and Cover Cropping for Enhanced Soil Quality and Weed Management in Western Washington Organic Vegetable Farms**

**Doug Collins, Chris Benedict, Andrew Corbin, Craig Cogger, Andy Bary, Carol Miles  
Washington State University, Pullman, WA**

### **Introduction**

Organic growers are inherently concerned with the quality of soil and certified organic producers must select and implement tillage and cultivation practices that maintain or improve the physical, chemical, and biological condition of soil and minimize soil erosion (USDA, 2010). High-value vegetable producers in the Pacific Northwest use tillage widely to manage plant residue, manage weeds, and

prepare the seed bed for planting. Increasingly, researchers and growers are weighing the agronomic benefits of tillage against potential deleterious effects on soil structure, soil erosion, soil compaction, excess fuel consumption, and contribution to greenhouse gases. Many growers are looking to incorporate reduced till systems onto their farms. The long-term goal of this integrated research and Extension project is to increase organic farmer economic and environmental sustainability in western Washington through soil conservation in reduced tillage systems. The specific goal was to evaluate how production methods that integrate cover crops and reduced tillage technologies affect soil quality, in-season weed pressure and seed bank populations on western Washington organic farms.

## **Materials and Methods**

**Field experimental design and agronomic activities** An experiment to evaluate cover crop phenology, biomass, and agronomic performance, weed management, and cash crop yield with different cover crop termination and reduced tillage ground preparation strategies was repeated at the Washington State University (WSU)-Puyallup Research and Extension and the Mount Vernon NW Washington Research and Extension Center. At WSU Puyallup we also compared soil health in low- and no-till vegetable production systems and a standard organic system throughout the growing season.

The experiment conducted at both Puyallup and Mount Vernon was a modified split-plot design with three replications, with cover crop as the main treatment and cover crop termination strategy as the first split. It was modified so that subplots were implemented onto only one or two of the main plots. The experiment included four cover crop varieties, Strider barley, OR09913 barley (Oregon State University), 'Lana' vetch, and 'AC Greenfix' chickling vetch, that were all seeded in fall 2010. All ground was prepped for seeding by disking, spading (Puyallup), or roto-tilling (Mount Vernon) as necessary. Target seeding rates were 100 lb/a for the barleys and 60 lb/a for the vetches. Cover crop maturation, biomass, percent N, and weed population data were taken from all of the main plots at both locations.

Five different combinations of cover crop termination and tillage strategies (subplots) were implemented in Spring 2011 in the 'Strider' main plots at both Puyallup and Mount Vernon: 1) flailing + no-till planting aid, 2) flailing + strip tillage, 3) rolling/crimping with no-till planting aid, 4) rolling/crimping + strip tillage, and

5) flailing + tillage. Cover crop termination and tillage treatments 1, 2, and 5 were also imposed on 'Lana' plots. Plots were 25 ft X 60 ft and subplots were 5 ft X 60 ft. Squash was transplanted into both the 'Strider' and 'Lana' plots at Puyallup, but only 'Strider' at Mount Vernon. 'Lana' plots at Mount Vernon were terminated 30 days after tillage activities due to excessive weed pressure. Weed populations were monitored in 'Strider' and 'Lana' at Puyallup and in 'Strider' at Mount Vernon.

Cover crops in the flailing + tillage treatment were flailed and then rototilled at Mount Vernon and flailed and spaded at Puyallup. The flailing + no-till planting aid and flailing + strip tillage treatments were flailed similarly to the tilled plots. A 2 m (6.5 foot) wide roller/crimper (I&J model 6FTCRO) was used to terminate cover crops in the roller/crimper + no-till planting aid and roller/crimper + strip tillage treatments. Following rolling/crimping or flailing, the strip-till treatment was imposed with a Yetter

model strip builder and the no-till planting aid treatment was imposed with a custom-built no-till planting aid consisting of a coulter and shank in-line.

In the subplots where tillage treatments were imposed, ‘Delicata’ squash was transplanted with 2 ft. in-row spacing and 5 ft. bed spacing. Fertilizer was provided through drip irrigation. The total application at Puyallup was 6 lbs N/ acre and the total application at Mount Vernon was 15.2 lbs/acre.

Cover crop maturity, biomass, and nutrient content. Cover crop maturity was monitored by recording development stage with the Zadok’s scale for barleys and by recording percent bloom for the vetch. Maturation stage was recorded four times from May 16 to June 6, 2011 at Puyallup and three times from May 16 to June 6, 2011 at Mount Vernon. Cover crop biomass and carbon and nitrogen content were calculated for each cover crop at both Puyallup and Mount Vernon (harvested on May 31, 2011). Biomass was determined by harvesting the total aboveground biomass from three 0.25 m<sup>2</sup> squares. A subsample of this composited harvest was analyzed for carbon and nitrogen content.

Soil chemical, physical, and biological analyses. Soil analyses were focused at the Puyallup site. Soil temperature was monitored hourly at 10 cm at both Puyallup and Mount Vernon with temperature probes and a data logger. Data logging occurred from June 29 to October 6, 2011 at Puyallup and from July 14 to October 20, 2011 at Mount Vernon. Earthworms were enumerated on July 15, 2011 at Puyallup using a ‘hot’ mustard (*allyl isothiocyanate*) extraction technique (Lawrence and Bowers, 2001) from the rolling/crimping + no-till planting aid, rolling/crimping + strip tillage, and flailing + tillage treatments. Two quadrants per plot (45.7 X 30.5 cm; 0.139 m<sup>2</sup>) were centered in the plant row. An additional two quadrants were taken 45 cm off center in the rolling/crimping + strip tillage, and flailing + tillage treatments. Earthworms were divided between anecic (deep burrowing and larger) and endogeic (transient in the soil and smaller) earthworms.

Weeding times and weed population dynamics. At Mount Vernon weed densities were recorded at four dates (July 7, July 20, August 4, and August 20, 2011) and at Puyallup on two dates (July 27 and August 10, 2011). Quadrants were placed over row middles during assessment. These “fixed” areas were left undisturbed (not hand weeded) throughout the growing season to capture true tillage effect on the weed population over time. Two biomass samples (1/4 m<sup>2</sup>) were taken from fixed areas (representing biomass accumulation from seasonal counts) and from one (1/4m<sup>2</sup>) area that had been managed [(hand-weeded)], weighed, then dried and re-weighed prior to squash harvest. A quick qualitative assessment, referred to as a weed map, of weed species was performed at both locations to outline species distribution.

Because light induces weed germination we measured light intensity (lumens ft<sup>-2</sup>) with light and temperature sensors (HOBO Pendant UA-002-08; Onset Computer Corp, Cape Cod, MA) placed at the soil surface and below cover crop residue throughout the growing season. Pendants were mounted with a rubber band on a small block of wood (7.6X 3.8 X 1.7 cm) to ensure the photo sensor was level. The mulch at the place where the sensor was to be installed was carefully removed and set aside. Using a hand trowel a hole was dug deep enough to bury the sensor so the soil would evenly reach the upper most plane of the pendant but leave the sensor exposed. The mulch was then replaced overtop of the



sensor to its original thickness, density, and structure. Data logging occurred from June 29 to August 30, 2011 at Puyallup (there was a gap between July 27 and August 10, 2011) and from June 27 to October 1, 2011 at Mount Vernon. To reduce weed pressure, timed hand-weeding events occurred at both locations; three at Puyallup (July 29, August 18, and August 29, 2011) and two at Mount Vernon (August 9 and August 25, 2011). Weeds were removed via hand pulling or with hand tools and total time spend weeding per plot, and number of people hand-weeding was recorded.

**Crop Yield and Maturity.** Squash was harvested on October 7, 2011 at the Puyallup site. There were very few mature fruits at the Mount Vernon site across all treatments so total above-ground biomass was measured by collecting three representative plants from each sub-plot on October 13, 2011.

**Statistical Analysis.** Both the statistical packages R and SAS were used for statistical analyses using the procedures AOV and GLM in R and SAS, respectively. Assumptions of homogeneity of variances were tested with visual observation (e.g., residuals versus fitted values) and with the Fligner-Killeen test. Earthworm values were log-transformed before analysis.

## Results and Discussion

Cover crop maturity, biomass, and nitrogen content. “Strider” and OR9913 followed similar phenological development at both Puyallup and Mount Vernon. Both crops were terminated at early dough development and termination was near 100 percent, though viable seed was produced. Flailing provided complete control of “Strider” and also prevented viable seed from forming. This is later than what others have considered optimum timing for rolling/crimping; Mirsky *et al.* (2009) found that rolling/crimping at the onset of flowering (60 on Zadok’s scale) provided greater than 85 percent termination in cereal rye. “Strider” produced around 4.5 tons/acre dry matter at Puyallup and 3.7 tons/acre at Mount Vernon with seeding rates of 76 and 120 lb/acre at Puyallup and Mount Vernon, respectively. OR09913 produced less biomass at both sites with 1.5 tons/acre at Puyallup and 2.2 tons/acre at Mount Vernon. “Lana” was terminated at 18 percent flowering at Mount Vernon and at 60 percent flowering at Puyallup. “Lana” produced 2.5 tons/acre at Puyallup and 3.1 tons/acre at Mount Vernon. When terminated, ‘Lana’ had 3.1 percent N content at both sites while “Strider” had 0.93 and 0.95 percent N content at Puyallup and Mount Vernon, respectively. Overwintering weeds were suppressed well by “Lana” and “Strider” at both Puyallup and Mount Vernon; total aboveground biomass was less than 15 percent weeds under “Lana” and less than 7 percent weeds under “Strider”. Weeds accounted for about one-third of the biomass with OR09913 at both sites. Chickling vetch was winter-killed at both sites.

“Delicata” Squash yield and soil nitrogen dynamics. “Delicata” squash yield was higher under “Lana” vetch (11.1 tons/acre) than “Strider” barley (2.2 tons/acre) at Puyallup. Since no roller/crimper treatment was included in the “Lana” plots we analyzed the influence of cover crop and three ground preparation strategies from both “Lana” and “Strider” together (Flail+PlantAid, Flail+StripTill, and Flail+Till). There was a strong cover crop effect ( $p=0.01$ ) and an insignificant tillage effect ( $p=0.16$ ). The increased yield following ‘Lana’ was likely due to increased N availability in soil from the legume cover crop. Fertilizer nitrogen input to the system was relatively low at both sites (6 and 15 lbs N/ acre at Puyallup and Mount Vernon respectively) and the added available N input from “Lana” was significant (estimated 70 lb/acre). A separate analysis of variance across the five cover crop termination

and tillage treatments in “Strider” found no significant difference in yield ( $p=0.32$ ). Mid-season soil nitrate averaged 26 ppm under vetch and 7.3 ppm under barley and no increase in nitrate availability was seen from type of tillage. Post-harvest nitrate values were also higher under “Lana” (6.7ppm) than “Strider” (3.6ppm). Cover crop termination and tillage treatment combinations did not significantly affect squash plant biomass at Mount Vernon following “Strider” ( $p=0.17$ ). A comment often voiced from those interested in adopting reduced tillage in organic agriculture is that without tillage the nitrogen from the cover crop will not be able to reach the cash crop. Our results indicate significant increase in both soil nitrogen and in cash crop yield in treatments where a legume was flailed and left on top of the soil. Biological decomposition and meso and macrofauna activity likely work together to increase soil nitrogen levels even in the absence of tillage to incorporate the residue.

Soil physical parameters. Soil temperature at 10cm was consistently 2-3 °F lower in no-till treatments compared to full tillage at the Puyallup site through mid-September. The same general trend was observed at Mount Vernon, though differences were not as great. The strip-till treatment did not affect soil temperature compared to the planting aid treatment. Soil drying and warming is an important benefit of tillage in the Maritime Northwest, and though we expected warmer soils to result in significantly greater yields, in 2011 the greatest differences in yield appear to be related to nitrogen input from the previous cover crop and not soil temperature.

Bulk density was lower in the flail + till treatment ( $p=0.001$ ) at both sites, but not different between planting aid and strip tillage. Infiltration was not different between treatments.

Soil biological parameters. In 2011, as in previous no-till trials, we saw a significant decrease in earthworm abundance and biomass due to tillage. Endogeic earthworms are worms that move horizontally through the soil. They are smaller but more abundant than anecic worms that form deep vertical burrows. The mean weight for an endogeic worm isolated was 0.6 g while anecic worms weighed an average of 4.8 g. Endogeic worms were negatively affected by both strip tillage and full tillage ( $p=0.001$ ) and there was no significant effect on anecic worms ( $p=0.30$ ) due to type of tillage.

To test the effect of strip tillage on earthworms in the strip tillage zone we isolated worms from the intra-row, or plant zone, and from the inter-row (45 cm off-center from plant row) in both strip tillage and tillage treatments. Location significantly affected total earthworm biomass in the strip-till treatment ( $p=0.02$ ), but not in the tillage treatment (tillageXlocation effect,  $p=0.05$ ).

One of the perceived benefits of strip tillage is that it disturbs only a narrow band of soil. Our results indicate that earthworms in the inter-row zone are “protected”; there was nearly 3 times the earthworm biomass in the inter-row zone in the strip tillage treatment compared to both the plant zone (i.e., strip tilled) and the inter-row zone in the full tillage treatment.

Weed dynamics and light intensity. Overwintering weed populations (within cover crops) were fairly consistent across locations, despite varying seeding rates and cover crop biomass. Weed density was significantly lower in reduced tillage plots when compared to tilled plots at both sites through mid-

August ( $p=0.01$ ; 44 and 60 days after transplanting (DAT) at Puyallup and Mount Vernon, respectively). No difference was observed between cover crops (“Strider” versus “Lana”) among reduced tillage treatments at Puyallup. Weed biomass samples exhibited no significant differences between treatments (fixed or hand-weeded) by 105 DAT. This suggests that while reducing tillage can reduce weed density, those weeds that do germinate, emerge, and survive accumulate greater amounts of biomass. When the weight/plant was calculated there was no significant difference within the fixed quadrant areas. At 105 DAT all reduced tillage plots had significantly lower weed density in areas that had been hand-weeded at the Mount Vernon site. Fixed plots had higher weed densities than hand-weeded plots in all reduced tillage treatments at both sites. At Puyallup, reduced tillage plots resulted in significant reductions in weeding times. “Lana” vetch flail + planting aid treatment was not significantly different than the conventionally tilled plots, though one replication had an unusually high weeding time. At Mount Vernon there were no observed differences in hand-weeding times.

Average daily light penetration remained consistently low below the mulch layer created by both flailing and rolling/crimping throughout the season in “Strider” at both sites compared to the till treatment. Flailed ‘Lana’ did not block light better than the tilled treatment in late August.

## **Conclusion**

We can conclude from these findings that organic reduced tillage systems can effectively suppress weed populations through the critical weed free period of a crop (first 30% of the crops life). The benefits of this early-season weed control are compromised by the inability to control weeds that do emerge with readily available cultivation equipment. Most cultivation equipment has been designed to be used in conventionally tilled systems, leaving hand-weeding as the most likely alternative currently. Further work is needed to identify potential cultivation tools that can be used in high residue systems.

## **References**

- Lawrence, A. P., and Bowers, M. A. (2002). A test of the 'hot' mustard extraction method of sampling earthworms. *Soil Biology and Biochemistry*. 34(4): 549-552
- Mirsky, S., W. Curran, D. Mortensen, M. Ryan and D. Shumway. (2009). Control of Cereal Rye with a Roller/Crimper as Influenced by Cover Crop Phenology. *Agronomy Journal*, 101, 1589-1596.

## **Session 2 K**

**Track/Session: Marketing Opportunities/Marketing Resources**

**Using Project Sign Post: A Direct Farm Business Regulation Outline and Farm To School FAQs to Assess Farm-to- School Readiness**

*Deborah Cavanaugh-Grant, Karen Bonsignore, Lissa Burt, Bill Cook, Justin Jacques and Nichole Meister, University of Illinois*

**Using Project Sign Post: A Direct Farm Business Regulation Outline and FAQs to Assess Farm to School Readiness**

**Karen Bonsignore, Lissa Burt, Bill Cook, Justin Jacques, and Nichole Meister  
MSLOC Program at Northwestern University,  
and  
Deborah Cavanaugh-Grant  
University of Illinois Extension  
Springfield, IL**

**Purpose of Project Signpost: Need & Concept**

Under the 2009 Local Food, Farms and Jobs Act, Illinois schools that spend at least \$25,000 per year on food are encouraged to purchase 10 percent of their food locally by 2020. As a first step toward achieving this goal, the State task force examined over a dozen obstacles that impede progress in local farming, including that farmers “have insufficient access to relevant and/or coordinated data.”

**Purpose of Project Sign Post: Value**

Despite high demand, promising economics, and the fact that four-fifths of Illinois is farmland, most locally produced food is not going to local markets, and the state has not yet been able to reach the target of 10 percent of food in Illinois schools being produced locally. According to The University of Illinois Extension “Guide for Planning Local Food Systems,” farmers cite various barriers to entering the school food supply chain. Barriers cited by growers include crop selection and production practices (61 percent); marketing and public relations (57 percent of growers); greenhouse growing and management (40 percent of growers); and business plan development (37 percent of growers).”

There are a number of websites, databases, and educational programs exist to support interested farmers in becoming a productive part of the school food supply chain. There are also existing programs and organizations that offer training, cost-sharing, and informational services to Illinois farmers. However,

these resources are not coordinated or centralized, making it difficult for farmers to access them and to effectively share knowledge and best practices. While this project has focused on Q&A around regulations, we anticipate that the model could be expanded for other question areas.

By organizing available resources to address the specific questions and concerns farmers have about supplying the school food system, we will enable farmers to take the first steps to meet the demands and requirements of the system in an economically viable way. Most importantly, we will provide access to resources that can assist them in the process. While initially educational, we expect that this will lead to economic value as farmers utilize the information and work to become part of the system. Our proposal also offers value to stakeholder organizations, like those of our client/partner organizations that want and need a hub for the various resources available to farmers. Finally, the Signpost Inventory will allow all stakeholders to identify gaps in the existing education and training resources available to farmers, enabling them to improve and expand their offerings.

### **Purpose of Project Signpost: Scope**

Scope:

While the design of the project was meant to plan for FAQs in other areas related to Farm-to-School sales, the specific scope of the project was limited to FAQ and regulations relating to the Farm-to-School process, for farmers in the state of Illinois selling vegetables (unprocessed), who were or wanted to sell to schools in Illinois. The project will leverage information and data that are publicly available, and will use existing institutions and organizational channels for delivery.

### **Overall Design: Design Criteria and Concept**

#### **Learning Theory:**

Ill-structured problem: The farm-to-school supply chain is an “Ill-structured problem,” and our goal was not just to compile information to farmers, but to provide them with a larger context for their role within the supply chain. We did this by:

- Defining two potential situations or “farmer-types” at the front of the deliverable. Not only did this offer a way for farmers to relate to the document, but it also forced them to acknowledge the other farmer-type and the potential implications of that. For instance, a farmer who has little-to-no experience with direct farm marketing learns just by selecting their farmer-type that setting up a direct farm business is a necessary first step to selling products to schools.
- Outlining the challenges of purchasing local food from the perspective of school food service personnel; this encourages the farmer to think outside their own experiences/challenges and to begin thinking about how they can help their customer, and therefore, help themselves.

- Outlining relevant supply chain specifics in the “what you need to know” sections, such as the different food service management models.
- By providing examples and case studies that outline successful models and introduce other “players” in the supply chain (wholesalers, distributors, food service management companies, etc.).

### **Skill, Will, and Hill:**

In looking at the farmers’ individual performance within the farm-to-school supply chain, the farmers (presumably) have the necessary farming skills and knowledge, or the “Skill” elements. The “Will” elements are largely taken care of by the demand for local food and the associated financial benefits “extrinsic motivation.” However, the “Hill” components are a problem. We learned through our research that farmers are lacking the information, resources, and other external factors necessary for success. Therefore, we decided that based on our “sphere of influence” and time constraints that compiling information and organizing it specifically for the farmer audience would be the most useful way to put a dent in the “Hill” barriers.

### **Self-Efficacy:**

Our research revealed that many farmers are overwhelmed by the obstacles associated with selling their produce to schools. So, we included as many examples and case studies as we could find to provide a type of “vicarious learning.” Our hope is that by learning about peers who have succeeded in selling their products to schools, the farmers would experience an increased self-efficacy associated with their own ability to successfully navigate the farm-to-school supply chain.

### **Usability Goals**

- Relevancy making it searchable and indexed so farmers can go directly to the areas they are interested in.
- Intuitive Navigation requires very little direction or instruction for a farmer to use the tool.
- For practicality, provide checklists that farmers can use to monitor their own progress through the tool

### **Growth & Sustainability**

- Flexibility in adoption and sustainability (see Sustainability Recommendations below) some ideas are provided for how to use this information. From a design perspective, tools were used that everyone had access to (for example, the basic information is kept in WORD rather than in a database), so that the content could be easily migrated to whatever form best fits the clients use.

- Structure: While only a limited scope of information currently populates the tool, the structure allows for other topic areas to be built, within the structure.

## Overall Design: Information Structure

As described previously, the design is for two different audiences: farmers who are not yet set up to sell farm direct, and those who are already set up to sell farm direct but want to sell to the specific market of schools.

Part One: Because farm-direct sales have a wider audience group, there are more resources currently available. A decision was made not to make these comprehensive, but to provide a checklist, some key considerations to be aware of, and then provide references to available resources.

Part Two: Farmers who self-select to go to Part Two have met all the criteria for farm-direct sales. Note that while many of the FAQs listed are relevant for farmers regardless of product, the tool focuses only on vegetables where regulations differ by product. A summary of the design is shown in Figure 1

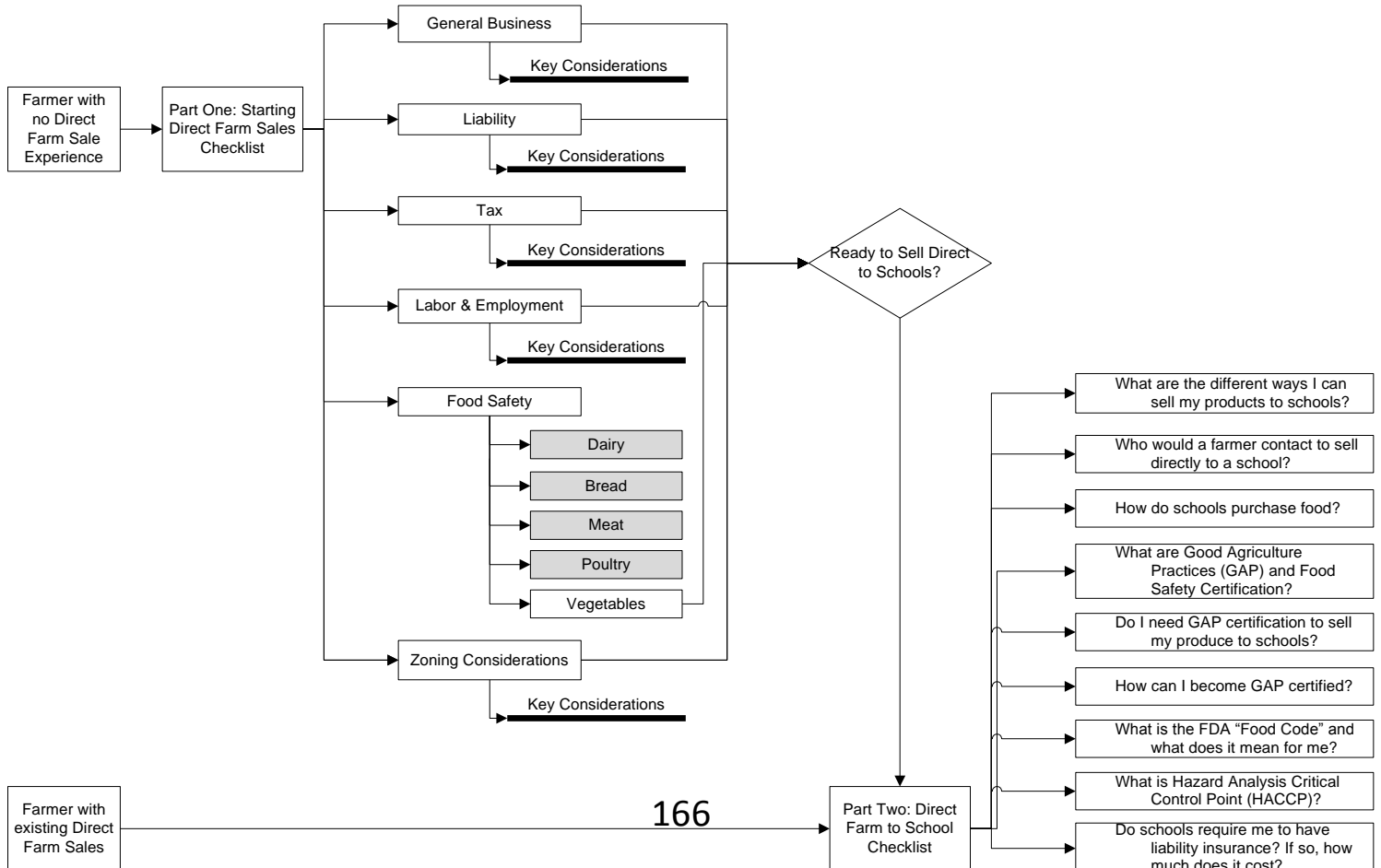

## **Figure 1. Design of the Farm-to-School Supply Chain**

### **Adoption: Suggested Applications for Use**

As a handout for farmers:

- Add to reference materials in class
- Stock, as available, with other reference information, or include in downloadable files online (PDF only)

As content and/structure for additional formats:

- Classroom learning – paired with practical examples, it could be used as a basis for a webinar
- Website – the information flow is designed to be hyperlinked, and could be easily transitioned to a website, so that users could navigate back and forth between topics of interest, and outside resources.

### **Direct Online Marketing of Food Specialty Products: A Resource for Business Owners and for Educators**

*Connie Hancock; Jay Jenkins; Jennifer Nixon, University of Nebraska – Lincoln; Glenn Muske  
North Dakota State University; Mary Peabody, University of Vermont*

### **Direct Online Marketing of Food Specialty Products: A Resource for Business Owners and for Educators**

**Connie Hancock; Jay Jenkins; Jennifer Nixon  
University of Nebraska – Lincoln**

**Glenn Muske**



## North Dakota State University

Mary Peabody

University of Vermont

### Key Workshop Points Covered

Starting a food-based business is often thought to be a great opportunity for many small farmers. The idea of adding value, and thus increasing one's return, seems like a natural fit. Plus it is not uncommon to have friends and family encouraging such possibilities.

Yet the old adage, "build it and they will come", remains a stubborn myth among these small business owners. The reality is that after meeting local community demand for the product, finding additional markets often proves to be a greater challenge than expected. Word-of-mouth only goes so far in continuing product demand.

Direct marketing online of food specialty products offers potential for small business owners. This workshop will introduce attendees to a new online curriculum designed to help small business owners examine direct online marketing. No longer is an online presence an option; it is a necessity. Yet each business owner needs to determine just what and how much online presence they need and can maintain.

The curriculum discusses:

- Should your business be online?
  - Short answer – YES!
- Tips on how to get your online presence started including a look at various online tools and how each can fit into the owner's marketing plan.
- The importance of branding and steps you can take as an owner to brand your business
- Unique challenges of selling food products online
- Website development
  - And once built, the challenge of getting found. It is not "build it and they will come."
    - Includes:
      - Search engine optimization
      - Key words
      - Meta tags
      - Titles
      - Headings
      - Image tags
- The importance of claiming your place on various online mapping tools

- Using social media in your online efforts
- Measuring the effectiveness and impact of your online efforts using various analytical tools
- Future trends

Ecommerce continues to be a growing trend with greater and greater numbers of people using the Internet to purchase goods and services more often and in larger amounts. As individuals become more familiar and comfortable with the technology and as security issues are alleviated and discussed, the use of online marketing will only increase in importance.

## Workshop Handout –

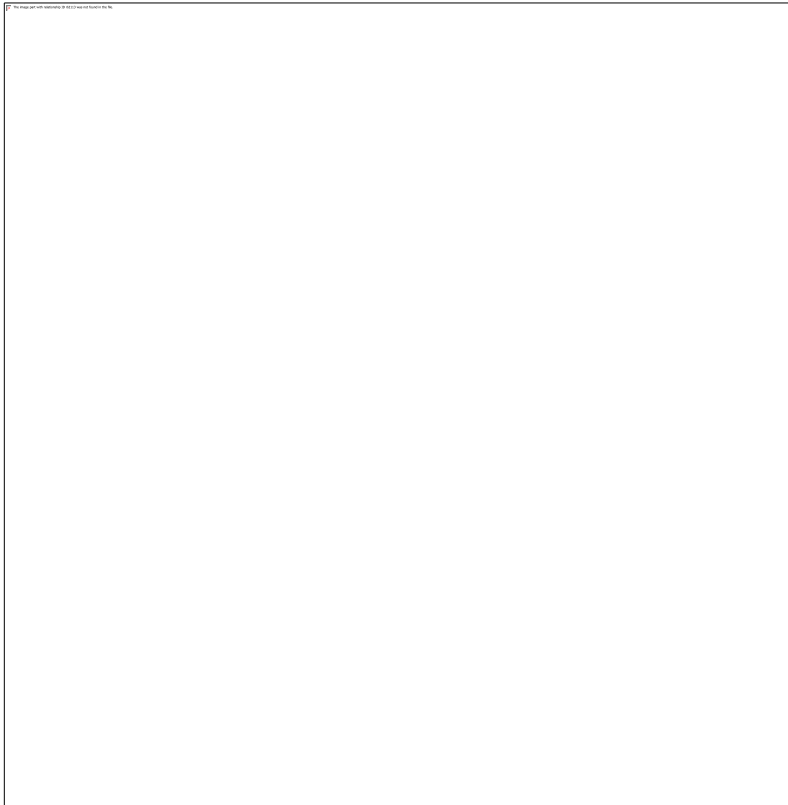

To access: <http://go.unl.edu/DirectMarketingFood>

Designed to provide business owners with strategies and tools to help sell directly to consumers. This online curriculum can be utilized by business owners 24/7.

The self-directed program allows business owners to:

- \* Evaluate the role of technology in the business
- \* Examine how to weigh the costs and benefits of technology
- \* Understand online marketing tools
- \* Learn how to build an online presence

## Session 2 L

### Track/Session: Outreach to Underserved Communities/Management Strategies Part III

#### Working with Small Farmers Promoting Sustainable Livestock Production System

Uma Karki, Nar K. Gurung, Jeffery Moore, and Alphonso Elliott, *Tuskegee University, Tuskegee, AL*

#### Working with Small Farmers Promoting Sustainable Livestock Production System

Uma Karki, Nar K. Gurung, Jeffery Moore, and Alphonso Elliott

Tuskegee University, Tuskegee, AL

#### Introduction

Ruminant livestock species are important in Alabama agriculture. Alabama has 1.23 million cattle and calves, which accounts for the second topmost farm commodity with cash receipts of \$395.8 million (NASS, 2011). Meat goats are another important livestock species for limited resource producers in Alabama, with 53.5 thousand head in January 2012 (NASS, 2012). Most of the cattle and goat producers are small-scale, limited resource producers with 76 percent of the cattle producers having herd size less than 50 (NASS, 2007), and the median meat goat herd size 18 with average pasture acreage of 10 (Karki et al., 2011a). Both of these livestock farming are based on pastures. To do well in livestock business, producers need to have a good pasture that is productive throughout the year. However, most producers, especially the limited resource producers, in Alabama have warm-season grasses dominated with bahiagrass and bermudagrass that produce from April to October (Ball et al., 2007; Karki et al., 2011b). This situation gives rise to a ‘winter slump’ period from November to March, when producers need to invest in supplementary feedstuffs to sustain their livestock. Sustaining livestock on supplementary feeds for long periods each year is not cost-effective for limited resource producers. To mitigate this situation, Tuskegee University Cooperative Extension Program (TUCEP) is working with livestock producers with the following objectives:

- 1) To educate livestock producers for improving and sustainably managing their pastures and grazing lands;
- 2) To provide the livestock producers with experiential learning opportunities by involving them in “year-round pasture production and grazing management” demonstration program
- 3) To identify the suitable forages for goats through on-farm research and disseminate the findings to goat producers for improving their pastures.

#### Methods

**Objective 1:** The education program was initiated in 2009 by developing training curricula on “year-round pasture production and management” and conducting training for field Extension personnel using the curricula for the very first time at Tuskegee University. Since then, the training is conducted

annually at different locations targeting livestock producers and field extension personnel. USDA representative are invited in each training session to deliver information on the available USDA support for livestock producers for improving their pastures and grazing lands. Information obtained from on-farm research was incorporated in the training program.

**Objective 2:** Demonstration program began in 2011 by involving interested, lead livestock producers who were already trained in “year-round pasture production and grazing management program” as mentioned under Objective 1 in this section. This is a partnership program where producers are responsible for all operations and inputs, except forage seeds, required for pasture improvement and grazing management. TUCEP provides technical support and forage seeds for up to five acres of pasturelands for three years. Producers are encouraged to work with USDA field offices (National Resources Conservation Service, Farm Service Agency, and Rural Development) and obtain possible support to develop facilities necessary for controlled grazing (fence, water). This program provides with the experiential learning opportunities to the participant producers on improving the existing pastures and sustainably managing the improved pastures by adopting an appropriate grazing system. By going through this program, producers gained the required skills and were encouraged to improve and sustainably manage the remainder of their pastures. Moreover, these sites were used to conduct hands-on training, field days, and study tours to educate other livestock producers from the local areas and beyond.

Objective 3: On-farm research on winter forages is ongoing at the farms of two cooperator goat producers each from Selma and Phenix City, AL. The study was set up as a randomized complete block design with three replications in each site. Each replication contained six equal strips, where the selected treatments and a control were randomly allocated. Five treatments: mixtures of Marshall Ryegrass (*Lolium multiflorum*) and one of the selected cool-season legumes (arrowleaf clover, *Trifolium vesiculosum*; berseem clover, *Trifolium alexandrinum*; crimson clover, *Trifolium incarnatum*; hairy vetch, *Vicia villosa*; and winter peas, *Pisum sativum*) and a control of sole Marshall Ryegrass were tested in the study. Seed rate for all grass-legume mixtures contained 60 percent grass and 40 percent legume seeds. Perimeter and cross fencings were established to develop each replication as a paddock for rotational grazing. Continuous water supply was made available to each paddock for the grazing goats. When forages were well established and reached the grazing height, three biomass samples from each strip were clipped to 5 cm within 0.25 m<sup>2</sup> quadrats before each rotational grazing began in each replication throughout the 2012 cool-season growing period (January to April). After sample collection, goats were allowed to graze the paddocks rotationally. Goats used in this study were mostly Boer, and few Kikos and Nubians in Selma, and Boer and crosses of Boer, Kiko, or Spanish in Phenix City. Forage heights both before and after grazing were measured. During the cool-season growing period, samples were collected three times (sampling sequence 1-3) in Selma and twice in Phenix City study site. Forage biomass data were analyzed using the Mixed model (SAS 9.3) with block as “random” and sampling sequence as “repeated” factors without specifying any covariance structure as this produced the best “fit statistics” for the data set (Littell et al., 2006). Treatment and sampling sequence were the main sources of variation. Alpha probability level for rejection of the H<sub>0</sub> (null hypotheses) in favor of H<sub>a</sub> (alternative hypotheses) was set at 0.05.

## **Results and Discussion**

### **1. Educational Programs**

Nine field Extension personnel and 98 livestock producers were trained on “year-round pasture production and grazing management” since the program was initiated. Trainees’ knowledge on soil test,

lime, and fertilizer applications, forage selection and establishment, and sustainable grazing management was increased by 43 percent after the training. Sixty-five percent of the trainees expressed that they were very likely to test pasture soils regularly and apply necessary lime and fertilizers, plant suitable grasses and legumes to improve their pastures, and manage their pastures with rotational grazing system. Seven of the trainees are currently participating in “year-round pasture production and grazing management” demonstration program, learning by doing, and improving their pastures. The demonstration program provided the participant producers with experiential learning opportunities.

## 2. On-Farm Research

Average grass and legume forage dry matter production in Selma study site is presented in Table 1. There was no treatment effect on grass dry matter production. However, treatment showed significant effect on legume dry matter production with the highest values for crimson clover Marshall ryegrass and hairy vetch Marshall Ryegrass treatments (Table 1). Goats readily consumed forages from all treatments throughout the cool-season grazing period, except winter peas at the very first grazing. From the second grazing, winter peas were also readily eaten by goats. Both grass and legume forage heights after grazing were significantly reduced compared to the heights before grazing for all treatments (Table 2). Unlike in Selma, the Phenix City site had scarce legumes; so, treatment effect on forage production was not manifested. However, the forage consumption patterns of goats remained similar to that in Selma.

**Table 1.** Average grass and legume forage dry matter production (LS means  $\pm$  SE) from different treatments during the 2012 cool-season growing period, Selma, AL.

Treatment	Forage dry matter (ton ha <sup>-1</sup> )	
	Grass	Legume
Arrowleaf clover ( <i>Trifolium vesiculosum</i> )-Marshall ryegrass ( <i>Lolium multiflorum</i> )	0.79 $\pm$ 0.000	0.27 $\pm$ 0.007 <sup>‡b</sup>
Berseem clover ( <i>Trifolium alexandrinum</i> )-Marshall ryegrass	0.77 $\pm$ 0.000	0.10 $\pm$ 0.005 <sup>c</sup>
Crimson clover ( <i>Trifolium incarnatum</i> )- Marshall ryegrass	0.58 $\pm$ 0.000	0.77 $\pm$ 0.010 <sup>a</sup>
Winter peas ( <i>Pisum sativum</i> )-Marshall ryegrass	0.64 $\pm$ 0.000	0.31 $\pm$ 0.008 <sup>b</sup>
Marshall ryegrass	0.87 $\pm$ 0.000	0.03 $\pm$ 0.006 <sup>d</sup>
Hairy vetch ( <i>Vicia villosa</i> )-Marshall ryegrass	1.02 $\pm$ 0.000	0.49 $\pm$ 0.007 <sup>a</sup>

<sup>‡</sup> LS means for forage dry matter within a column with different superscripts are different (\*P < 0.05).

**Table 2.** Average grass and legume forage height (LS means  $\pm$  SE) before and after grazing different treatments during the 2012 cool-season growing period, Selma, AL.

Treatment	Forage height (cm)			
	Grass		Legume	
	Before	After	Before	After
ArrowleafRye <sup>†</sup>	19.7 $\pm$ 0.99 <sup>‡b</sup> <sub>x</sub>	8.7 $\pm$ 1.55 <sup>b</sup> <sub>y</sub>	13.7 $\pm$ 1.78 <sup>c</sup> <sub>x</sub>	6.6 $\pm$ 2.78 <sup>c</sup> <sub>y</sub>

BerseemRye	18.4 ± 1.07 <sup>b</sup> <sub>x</sub>	9.9 ± 1.55 <sup>b</sup> <sub>y</sub>	19.6 ± 1.91 <sup>b</sup> <sub>x</sub>	6.7 ± 2.78 <sup>c</sup> <sub>y</sub>
CrimsonRye	19.6 ± 1.03 <sup>b</sup> <sub>x</sub>	10.7 ± 1.55 <sup>bc</sup> <sub>y</sub>	24.7 ± 1.85 <sup>b</sup> <sub>x</sub>	12.5 ± 2.78 <sup>bc</sup> <sub>y</sub>
PeasRye	20.5 ± 1.07 <sup>b</sup> <sub>x</sub>	13.8 ± 1.27 <sup>a</sup> <sub>y</sub>	36.9 ± 1.91 <sup>a</sup> <sub>x</sub>	23.0 ± 2.28 <sup>a</sup> <sub>y</sub>
Marshall Ryegrass	19.4 ± 0.92 <sup>b</sup> <sub>x</sub>	8.7 ± 1.55 <sup>b</sup> <sub>y</sub>	-	-
VetchRye	23.9 ± 0.03 <sup>a</sup> <sub>x</sub>	12.8 ± 1.55 <sup>bc</sup> <sub>y</sub>	36.9 ± 1.85 <sup>a</sup> <sub>x</sub>	16.9 ± 2.78 <sup>ab</sup> <sub>y</sub>

† ArrowleafRye = Arrowleaf clover (*Trifolium vesiculosum*)-Marshall Ryegrass (*Lolium multiflorum*)

BerseemRye = Berseem clover (*Trifolium alexandrinum*)-Marshall Ryegrass

CrimsonRye = Crimson clover (*Trifolium incarnatum*)-Marshall Ryegrass

PeasRye = winter peas (*Pisum sativum*)-Marshall Ryegrass

VetchRye = Hairy vetch (*Vicia villosa*)-Marshall Ryegrass

‡ LS means for forage height within a column with different superscripts, and within a row under grass or legume category with different subscripts are different (\*P < 0.05).

## Conclusion

Educational programs were quite effective to increase the skills and knowledge of livestock producers in improving the existing production system. On-farm research results showed that crimson clover Marshall ryegrass and hairy vetch Marshall ryegrass mixtures were the most productive among the selected treatments. Moreover, the findings indicated that any mixture of Marshall Ryegrass and selected legumes could be planted to improve goat pastures although goats require some time to get used to winter peas. Findings of this study will be very useful for goat producers in Alabama and neighboring states for enhancing pastures and reducing production costs, which will eventually promote the sustainability of goat farming. Future study plan includes the assessment of production costs and animal performance associated with the improved pastures.

## Acknowledgements

Authors acknowledge the Southern Sustainable Agriculture Research and Education Program for funding the on-farm research, and goat producers Mr. Gregory Scott and Mr. Nimrod Stephens for their cooperation while conducting the research.

## References

Ball, D.M., C.G. Hoveland, and G.D. Lacefield. (2007). Southern Forages, 4<sup>th</sup> ed. The International Plant Nutrition Institute (IPNI), Norcross, GA.

Karki, U., N. Baharanyi, D. Moxey, A. Elliott, J. Moore, A. Jackson, and W. Baldwin. (2011b). Extension education and research needs of livestock farmers in Alabama. 16<sup>th</sup> Biennial Research Symposium, Association of Research Directors, Inc., April 9-13, Atlanta Marriott Marquis, Atlanta, Georgia. (Abstract and poster presentation)

Karki, U., N.K. Gurung, A. Elliott, L.B. Karki, and O. Bolden-Tiller. (2011a). Current Situation and Further Training Needs: A Case of Master Goat Producers. American Society of Animal Science -

ADSA-ASAS 2011 Joint Annual Meeting, July 10-14, 2011, New Orleans, LA (United States).  
(Abstract and poster presentation)

NASS. (2007). Cattle and Calves Herd Size by Inventory and Sales: 2007. 2007 Census Publication, Volume 1, Chapter 1, State Level Data: Alabama. National Agricultural Statistics Service, U.S. Department of Agriculture.

[http://www.agcensus.usda.gov/Publications/2007/Full\\_Report/Volume\\_1,\\_Chapter\\_1\\_State\\_Level/Alabama/st01\\_1\\_014\\_016.pdf](http://www.agcensus.usda.gov/Publications/2007/Full_Report/Volume_1,_Chapter_1_State_Level/Alabama/st01_1_014_016.pdf) Accessed on August 9, 2012.

NASS. 2011. Alabama agricultural statistics. 2011 Bulletin 53. National Agricultural Statistics Service, U.S. Department of Agriculture.

[http://www.nass.usda.gov/Statistics\\_by\\_State/Alabama/Publications/Annual\\_Statistical\\_Bulletin/2011/2011AlabamaAgricultureStatistics.pdf](http://www.nass.usda.gov/Statistics_by_State/Alabama/Publications/Annual_Statistical_Bulletin/2011/2011AlabamaAgricultureStatistics.pdf) Accessed on August 9, 2012.

NASS. 2012. Sheep and goats. National Agricultural Statistics Service, Agricultural Statistics Board, U.S. Department of Agriculture.

[http://www.gov.mb.ca/agriculture/statistics/livestock/nass\\_sheep\\_and\\_goats.pdf](http://www.gov.mb.ca/agriculture/statistics/livestock/nass_sheep_and_goats.pdf) Accessed on August, 2012.

### **Responding to the Needs of Socially Disadvantaged Livestock Producers**

*Niki Whitley, Michelle Eley, John O' Sullivan, Roberto Franco, Keesla Moulton, Keith Baldwin, James Hartsfield and Amanda Hatcher, North Carolina A & T State University*

#### Responding to the Needs of Socially Disadvantaged Livestock Producers

Niki Whitley, Ph.D., Michelle Eley, Ph.D., John O'Sullivan, Ph.D., Roberto Franco\*, Ph.D.

Keesla Moulton, Ph.D., Keith Baldwin, Ph.D;

North Carolina A&T State University, Greensboro, NC

James Hartsfield, Sampson and Duplin County Cooperative Extension, Clinton, NC and  
Kenansville, NC

Amanda Hatcher, Duplin County Cooperative Extension, Kenansville, NC

#### Introduction

**In North Carolina, sales of livestock represent 75 percent, or 7.7 billion, of the total market value of products sold (USDA Ag Census, 2007), and the majority of farms in N.C. are less than 50 acres in size. Because small-scale, socially disadvantaged livestock producers are often late-adopters of technologies needed for successful production and profitability, the Cooperative Extension Program at North Carolina Agricultural and Technical University developed a program focused on these groups. The overall goal of the small scale pasture livestock production program is to provide training to field staff and others to address the needs of socially disadvantaged and limited resource producers. The program objectives include increasing the number of producers participating in USDA programs/grant funding opportunities and increasing the number of best management practices used to support farm profitability and sustainability.**



## Program Description/Methods

The small-scale livestock production program consists of Extension faculty and staff at the State and County levels in agriculture and natural resources as well as community resource development. It provides up-to-date, research-based education and training for field staff and other agricultural professionals as well as livestock producers. Youth development events are occasionally incorporated as well. Collaborators include USDA and state governmental organizations, community- and faith-based groups and other universities. A whole-farm, interdisciplinary approach is used and various training methods are incorporated, including presentations at regularly held growers' schools, conferences, workshops and seminars, hands-on experiential learning activities, cooperative development and organizational leadership assistance, demonstration site development and farm tours. Professional development support is provided to field staff and producers.

Resources provided include topical handouts, fact sheets and other materials, and presentations and evaluation tools for trainers to use. One example is a biosecurity "tool kit" including a biosecurity plan template, forms with a clipboard for farm visitors to sign and biosecurity signs that producers could immediately use on their farms after training.

Immediate increases in knowledge, skills and abilities are often evaluated by an electronic polling ("clicker") type training system, the use of which increased survey response rates from 20 percent to 100 percent (SNAP™, Audience Response Systems, Inc., Evansville, IN). Needs assessments are conducted using the same system, surveys or discussion groups and changes made to programming based on impacts and assessments. Mid- to long-term impacts are measured using surveys designed for agents to fill out during farm visits with input from the producer.

Marketing approaches include use of the online extension management learning system for N.C. field staff, demonstration site farm social media sites (i.e. Facebook), presentations at field staff in-service and strategic planning council meetings, poster and oral presentations at national and regional meetings, and field staff marketing using newsletters, fliers and local media outlets.

## Results

The N.C. Natural Hog Producers Association, a marketing cooperative selling just at or above \$1 million worth of pigs each year, was developed in 2006 and has expanded. Working with the Association, 30 producers nearly doubled their gross income from hog sales.

The swine marketing group requires producer members to have several certifications. Examples include Pork Quality Assurance (PQA) and Transport Quality Assurance (TQA) as well as Animal Welfare Approved (AWA) certifications. Extension program staff helps the members attain the proper certifications through education and technical support.

Eight farmer-owned demonstration sites were developed and used for training at least 15 Extension and NRCS field staff so far. Fifty or more farmers also participated. An additional 12 Extension field staff were trained at other events such as field days and conferences. North Carolina A&T State University holds an Annual Field Day at the University Farm with livestock education included; Small Farm Week educational events at the University have also focused on local livestock production and marketing. The Cooperative Extension Program at NC A&T State University is also a partner in the Center for Environmental Farming Systems at the Cherry Research Farm in Goldsboro, N.C. Livestock training events are also held at CEFS as a part of the livestock program.

**A follow-up survey conducted with producers who had participated in the program at least two years indicated that technologies and best production practices have been incorporated into their farms (Table 1).**

**The survey also indicated that after training, 62% of participants applied to a USDA program or increased use of farm insurance, 83% treated for parasites more often or differently, 57% changed animal breeds and 50% applied for grant funding.**

**Table 1. Percentage of producers using specific best production practices before and after participating in the small scale livestock program focused on socially disadvantaged farmers.**

**Demonstration farm tours have been conducted for two years. A survey was provided to participants to evaluate short term impact. Respondents indicated an increase in knowledge about best management practices (Figure 1). A longer-term impact survey was provided to participants nearly a year after the farm tours and of those responding, 71.4% had used their knowledge to make changes to create a more environmentally– and/or animal–friendly farm. Cited changes included planting more forages and rotating animals, adding new pastures and shelters, giving pigs more space and moving pigs away from streams/other water sources.**

**Figure 1. Percentage of respondents indicating they increased their knowledge of specific best management practices during demonstration site farm tours.**

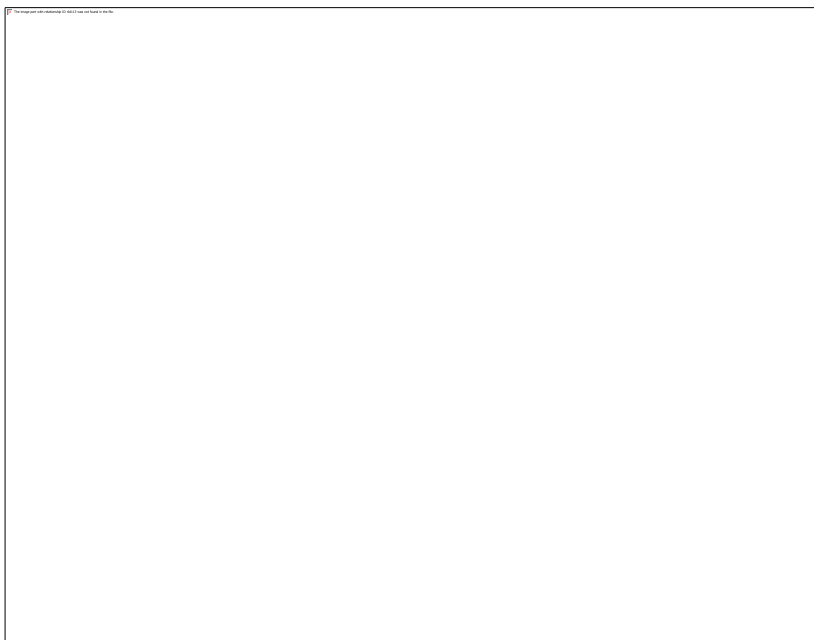

Summary/Future Plans

**The small scale livestock production program working socially disadvantaged and limited-resource audiences resulted in positive changes made on farms. These changes support local farms, communities and a healthy environment.**

**Because of the success of the demonstration sites, additional farms will be added and tours conducted.**

**Educational material drafts have been developed and will be published for widespread use. Needs assessments and trainings will also continue.**

**with**

## **Session 2 M**

## **Track/Session: Research and Extension Priorities/Economic Analysis**

### **Economic Based Decision Support to Promote Sustainable Livestock Enterprises**

*Joan Fulton, Anna Lee Allcorn, Nicole Olynk, Purdue University*

#### **Economic Based Decision Support to Promote Sustainable Livestock Enterprises**

**Joan Fulton, Nicole Olynk Widmar, Anna Lee Allcorn**

**Purdue University, West Lafayette, IN**

Small scale livestock operations are attractive to individuals who have a small amount of land or financial capital to invest, have other employment, or simply want to get involved in agriculture. Individuals looking to begin a part-time agricultural endeavor or existing farmers looking to diversify could find value in small scale livestock operations. Alternatively, their motive might just be their love of animals or to provide their children lessons in responsibility.

The output of this research/Extension assists individuals evaluating across multiple objectives make small scale livestock enterprise entry decisions through a Comparative Decision Support (CDS) tool package. Included in the tool package are selected enterprise budgets, a decision matrix, and a profit/loss model. Enterprise budgets based on small scale production decisions were developed for cow-calf, dairy steer, sheep, goats, and turkeys. These budgets were used as the quantitative base to develop the CDS matrix. The CDS matrix allows the user to compare and contrast enterprise alternatives using multiple decision criteria. To supplement the matrix is a profit/loss model to conduct sensitivity analysis such as best/worst case scenarios and input local market expectations. The CDS tool package provides expectations for a small scale livestock enterprise by displaying both quantitative and qualitative information and individualized output based on user input parameters. A producer from each represented enterprise was interviewed to determine production assumptions and assure realistic and usable parameters. The CDS tools are easily modified for local Extension audiences and are accessible to the general public on the website.

#### **Let us take a closer look at the CDS tools:**

##### **Comparative Decision Support (CDS) Matrix**

The CDS matrix is an interactive tool that incorporates the users resources (the amount of initial investment the user plans to spend and the acreage expected to devote to the enterprise) to return individualized financial information. Enterprise budgets based on small scale enterprises for cow-calf, dairy steer, sheep, goat, and turkey serve as the quantitative base of the CDS matrix. The CDS matrix allows the user to compare and contrast financial, time, and qualitative characteristics of alternative enterprises using multiple decision criteria.

### ***Enterprise Definitions***

Prior to using the CDS tools it is important to understand how each enterprise is defined. Additionally, the enterprise budgets used to create the CDS assumed small scale production practices based on a specific scale. For this reason the CDS will not return financial information for units greater than the upper bounds. The scale of an enterprise affects many of the production decisions and the impact of fixed costs on a per unit basis. The CDS is a starting point for planning, but further analysis into the actual scale of your enterprise should be conducted. The scope and scale of the enterprises used in the CDS is summarized in Table 1.

**Table 1. Enterprise Definition and Scale**

Enterprise	Definition summary	Budget Scale	Upper Bound
Cow-Calf	Hay and pasture, calves sold at 500 lbs.	50 cows	100 cows
Dairy Steer	Starting weight 350 lbs, market weight 700 lbs.	25 head	200 head
Sheep	Ewe flock, lambing Jan-Feb, market weight 125 lbs.	150 ewes	300 ewes
Goat	Does kidding for meat goats, market weight 80 lbs.	100 does	300 does
Turkey	Hens, poults purchased at 1 day old, marketed at 14 weeks	3,000 birds	4,500 birds

### ***Investment and Acreage***

The CDS asks the user to provide investment and acreage parameters, which are used to return the maximum number of head that could be supported initially. Remember that the investment is what would need to be paid up front to begin the enterprise; the CDS will return an estimate of operating expenses per year based on the maximum number of head from your input. All numbers found in this tool package are based on 2011 national data; therefore, it is important that the user study their local market prices prior to investment. The user can update numbers in the interactive CDS tool package on the prices tab in order to personalize the tool to their local situation.

### ***Interpretation***

The CDS matrix returns information to provide potential expectations of each of the enterprises. Numerical information provides a potential scale that may be attained based on the users investment/acreage requirements. Total time (how many hours to devote in a production cycle/year) and frequency of time (how many days per week) are included along with ease of entry and exit. The user should consider their time availability and willingness to work in year round production and compare to the CDS output. Also they should think about their access to different market types and permanent structures (buildings used in the enterprise). This may be a constraint to choosing some enterprises. Finally, the user should think about why they want to begin a small scale livestock enterprise.

### **Expectations for Individual Situations: CDS2**

In the CDS matrix, returns are estimated from the financial information for the maximum number of head the user could potentially support based on their initial investment and acreage. Then, the CDS2 allows the user to select the scale of the enterprises and returns an estimate of the profit/loss on the

enterprises. In addition to choosing the scale of the enterprises, the CDS2 allows the user to change input and sale prices from those provided as a base.

### *Uses for CDS2*

The CDS2 can be used to reflect the user's local market prices. For instance, the user may be able to get hay for \$100 per ton instead of the assumed \$150 per ton which would impact the profitability of the cow-calf, sheep, and goat enterprises.

The CDS2 is also useful for doing a best case/worst case analysis. Consider returns using the lowest price the user could buy inputs and the highest price for livestock in their local market. Then the user could compare the profit/loss to the highest priced inputs and lowest priced livestock they foresee. The CDS2 is also useful when the user is thinking about the level of risk they are willing to take in their livestock enterprise. Can they handle the worst case scenario? If not, the user should consider changing the scale of the enterprise or not choosing that livestock enterprise.

If the user is considering a niche marketing opportunity, they can enter the price they think they will be able to get to see the impact on profit/loss. It is important that the user remain aware that they may have to change production practices that will impact the cost of raising animals sold in a niche market. This will impact the enterprise profit/loss, with the potential to impact both costs and revenues.

Finally, the user can use the CDS2 to reflect the impact of the value of their time. In the CDS it is assumed that their time is worth \$14 per hour. The user can adjust the value of their time in the CDS2 to reflect a higher value or to reflect a zero value since the value of time may not actually be impacting the cash flow of the enterprise. If the user is planning to hire labor for the operation they can also adjust the labor expense to reflect the estimated wage rate of the labor.

Now let us look at some example situations to better understand the application of the tools that have been discussed.

#### Example: Motivated by Lifestyle

A couple is interested in beginning a small scale livestock enterprise because they desire the lifestyle characteristics inherent in a rural based operation. Each individual in the household has an off-farm income source that will continue at the current level. The couple has 40 acres, \$25,000 initial investment, existing permanent structure, urban and traditional market access, and 20 hours per week to devote to the livestock enterprise.

Comparative Decision Support Matrix					
Criteria	Livestock Enterprise				
	Cow-Calf	Dairy Steer	Sheep	Goat	Turkey
Maximum Number of Head	<b>16</b>	<b>56</b>	<b>92</b>	<b>78</b>	<b>4500</b>
Initial Investment Needed	<b>\$ 24,752.00</b> \$1547 investment/unit	<b>\$ 24,714.76</b> \$441.34 investment/head	<b>\$ 24,748.00</b> \$269 investment/unit	<b>\$ 24,882.00</b> \$319 investment/unit	<b>\$ 17,310.00</b> \$3.85 investment/bird
Acreage Used	<b>39.2</b> 2.45 acres/unit	<b>28</b> 0.5 acres/head	<b>18.4</b> 0.2 acres/unit	<b>23.4</b> 0.3 acres/unit	<b>9</b> 0.002 acres/bird
Operating Expenses	<b>\$ 14,069.00</b> \$879.31 cost/unit	<b>\$ 42,774.79</b> \$24192.03 in Year 1 \$763.84 cost/head	<b>\$ 23,678.96</b> \$257.38 cost/unit	<b>\$ 12,065.87</b> \$154.69 cost/unit	<b>\$ 61,318.27</b> \$54883.27 in Year 1 \$13.63 cost/bird
Feed Cost as a % of Operating Expenses	<b>57%</b>	<b>36%</b>	<b>49%</b>	<b>38%</b>	<b>63%</b>
Estimated Profitability	<b>\$ (1,857.80)</b> \$-116.11 profit/unit	<b>\$ (8,886.39)</b> \$-158.69 profit/head	<b>\$ 586.09</b> \$6.37 profit/unit	<b>\$ 6,472.86</b> \$82.99 profit/unit	<b>\$ (10,693.27)</b> \$-2.38 profit/bird
Total Labor Hours	<b>128</b> 8 hours/unit	<b>112</b> 2 hours/head	<b>460</b> 5 hours/unit	<b>156</b> 2 hours/unit	<b>720</b> 0.16 hours/bird
Permanent Structure	- Not important	- Not important	<b>o</b> Feed Storage	<b>o</b> Feed Storage	<b>+</b> Important
Labor Intensity	<b>Low</b> 2-3 times/week	<b>Medium</b> Almost everyday	<b>Low</b> 2-3 times/week	<b>Low</b> 2-3 times/week	<b>High</b> Everyday
Ease of Entry/Exit	<b>High</b> 180 days/ \$1,082 breeding stock	<b>Low</b> 150 days/ \$0 breeding stock	<b>Medium</b> 160 days/ \$159 breeding stock	<b>Medium</b> 252 days/ \$154 breeding stock	<b>Low</b> 98 days/ \$0 breeding stock
Niche/Urban Market Access	- Not important	- Not important	<b>o</b> Sometimes Important	<b>o</b> Sometimes Important	<b>+</b> Important
Livestock Market Access	<b>+</b> Important	<b>+</b> Important	<b>o</b> Sometimes Important	<b>o</b> Sometimes Important	- Not important

**Decision:** After going through the CDS, this couple decided to begin a cow-calf enterprise.

**Why:** The couple felt that having a herd that would be consistent from year to year would provide enjoyment. Additionally, the couple liked the flexibility of the low labor intensity associated with cow-calf because of their off-farm employment. The use of all 40 acres was important to the couple since they really wanted to get back to their rural roots and use their land in the operation as it had been used in their childhood memories.

It is important to note that the estimated profitability is an estimate that reflects very specific production assumptions and national prices. These estimates may be on target for the user's region or they might be higher or lower than what they could expect. Prior to beginning an enterprise, the user should delve further into the enterprise budgets, update prices, and change input quantities and investments to reflect the production decisions they plan to make.

## Session 2 N

**Track/Session: Marketing Resources/Ethnic Markets**

**Meat Processing Plants: Opportunities and Constraints for Tennessee Goat Producers**

*Clarence Pongo, Enefiok Ekanem and Mary Mafuyai-Ekanem, Tennessee State University*

**Meat Processing Plants: Opportunities and Constraints for Tennessee Goat Producers**

**Clarence Pongo, Enefiok Ekanem, Fisseha Tegegne, Surendra Singh**

**Tennessee State University, Nashville, TN**

**Mary Mafuyai-Ekanem**

**LaRun & Associates, Greensboro, NC**

## **Introduction**

Value addition in goat meat production involves the addition of value to the meat through processing that allows regular goat meat to be processed into more value added-products. As more value is added, prices increase enhancing the income of producers. Goat meat markets present good growth potential, due to the high demand for quality goat meat that is being driven by the influx of immigrants and growth of religious groups (Pinkerton et al., 1994). However, these markets lack the level of organization prerequisite to improving the supply of quality goat meat to the national market (Madruga et al., 2011). Value-added agriculture is, therefore, paramount in helping farmers gain a larger share of the consumer food dollar through value added processes and the creation or adoption of new technology or business processes that serve as an additional unit or an extension of the existing farm business with the development of local economies and job creation as by products. Several possibilities exist to process goat meat in order to make it more diversified and appealing to the market (specific cuts, products processed for functional and tertiary use, typical products, etc.), and there is currently knowledge available to fulfill these goals (Madruga et al., 2011).

The objectives of this paper are (1) to present a profile of Tennessee's meat processors, (2) to assess the capacity of Tennessee processing plants for handling goat meat, (3) to examine conditions under which plants would be willing to process goats in their facilities, and (4) to identify the constraints and opportunities facing goat meat processing plants in Tennessee.

## **Methodology**

Secondary data for this paper were collected from existing USDA, (Economic Research Service (ERS), National Agricultural Service (NASS), and Census of Agriculture and other available publications. Additional data will be collected using surveys and observational visits to facilities. Surveys would be administered through email, telephone interviews, and personal interviews. Primary data is still being collected. Statistical analysis tools such as SPSS, STATA and Excel will be used to run analysis on data collected.

## **Results**

Although this research is currently ongoing and data is still being collected, secondary data and literature collected from the published sources are presented in the brief discussion that follows. Table 1 shows the number of meat goats and other goats in Tennessee and the U.S. from 2009 to 2012. The data shows a slight decrease in numbers both in Tennessee and the U.S.

**Table 1. Number of meat goats and other goats in Tennessee and the United States**

Year	2009	2010	2011	2012
Tennessee	134000	125000	115000	121000
United States	2,549,000	2,538,000	2,464,000	2,356,000

**Source: USDA, NASS (2012)**

Literature reviewed shows that that meat processing facilities are grouped into three main categories: custom processing facilities, USDA-inspected processing facilities, and processing facilities credentialed for both (Bruch, 2010). Custom processing facilities are those that harvest animals for meat intended for personal use (not for sale) and are permitted by the Tennessee Department of Agriculture (TDA), Custom exemption, for both animal slaughter and meat processing, exempts processors from the requirements of federal inspection because they are being paid for the service of converting a meat animal into a meat product (Carr et al., 2011).

There are distinct requirements under this exemption, which are:

- Custom slaughter must only be for the personal use of the owner of the animal.
- The resulting product must be marked “Not for Sale.”
- The operator must maintain accurate production and business records.
- The animal and/or product must be prepared or processed in a sanitary manner.

USDA inspected processing facility harvest meat intended for sale. Since 1971, Tennessee and 25 other states have opted out of state-inspection meat programs and rely totally on federal inspection (Holland et al., 2003). To obtain federal inspection, the establishment must apply to the USDA Food Safety and Inspection Service (FSIS) for a “grant of inspection” to become an “official establishment” for meat, poultry, or both. In addition, the applicant must specify the meat processing activities that need inspection (i.e., slaughtering, boning, fabricating, curing, formulating). Slaughtering, processing, and boning are the terms used to describe the distinct stages for which inspection is provided. That is, meat entering commerce must be inspected at each of these stages, and facilities providing these services must be specifically inspected for each stage. A facility must apply for inspection for each specific operation that it wants to perform. USDA approval is granted independently for each function/operation. For example, a facility may be inspected for slaughtering but may not be an inspected facility for processing and boning. However, such a plant could still provide processing and boning services on a custom-exempt basis. In such a case, exempted activities performed must be specified on the application for inspection (Holland et al., 2003).



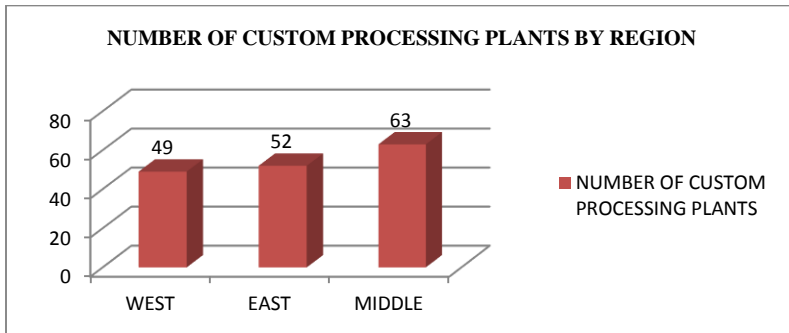

**Fig 1. Number of custom processing plants in Tennessee**

Source: Generated by author using figures from University of Tennessee (UT) Extension (2010)

From Figure 1 and Table 2, it can be seen that, there is a higher concentration of facilities in middle Tennessee compared to the eastern and western areas of Tennessee. A reason for this could be the fact that middle Tennessee has a larger number of livestock producers hence the higher number of processing plants located in Middle Tennessee.

**Table 2. Distribution of Custom processing facilities by counties.**

West Tennessee		Middle Tennessee		East Tennessee	
County	Number of Facilities	County	Number of Facilities	County	Number of Facilities
Benton	2	Bedford	1	Blount	1
Carroll	1	Cheatham	1	Bradley	3
Chester	1	Clay	1	Campbell	3
Crockett	1	Coffee	2	Carter	6
Decatur	1	Davidson	1	Claiborne	2
Dyer	3	Dekalb	2	Cocke	1
Fayette	1	Fentress	3	Cumberland	3
Gibson	3	Franklin	7	Grainger	1
Hardeman	4	Giles	4	Greene	5
Hardin	4	Grundy	1	Hamblen	3
Haywood	3	Hickman	2	Hamilton	2
Henderson	2	Lawrence	4	Hawkins	1
Henry	4	Lincoln	2	Jefferson	3

Lauderdale	4	Macon	1	Johnson	1
Madison	1	Marshall	4	Knox	2
McNairy	3	Maury	3	Loudon	2
Obion	3	Montgomery	3	Marion	1
Shelby	4	Overton	1	McMinn	1
Tipton	1	Perry	2	Meigs	2
Weakley	3	Putnam	3	Monroe	2
		Robertson	3	Roane	2
		Smith	1	Scott	1
		Sumner	2	Sequatchie	1
		Warren	1	Union	2
		Wayne	2	Washington	1
		White	2		
		Williamson	1		
		Wilson	3		

Source: Table generated by authors using data from Center for Profitable Agriculture (2010).

Table 3 shows the number of livestock slaughtered at USDA inspected facilities and other commercial slaughter facilities between December 2010 and December 2011 in the State of Tennessee. It can be seen that, there is a gradual increase in the number slaughtered.

**Table 3. Livestock Slaughter: Tennessee**

Species	Number Slaughtered		Total Live Weight		Average Live Weight	
	2010	2011	2010	2011	2010	2011
	1,000 Head		1,000 Pounds		Pounds	
Cattle	3.9	4.6	3,213	3,853	848	853
Calves	0	0.1	0	38	0	468
Hogs	53.5	66.2	24,760	29,546	463	447
Sheep and Lambs	0.7	0.6	54	44	78	74

Source: USDA, National Agricultural Statistics Service (2011)

## Discussion

Goat producers in Tennessee are faced with a number of challenges, including lack of slaughter capacity, the resistance by white Americans to goat meat, the difficulty in getting fresh goat products into retail stores, and the difficulty in meeting commercial dairy standards that were originally designed for cow dairies (USDA, 2013). A study by (Holland et al., 2003) found that, there were a limited number of USDA-inspected slaughtering facilities in Tennessee. According to data from the USDA, there are currently four meat processing plants in Tennessee approved to receive immediate slaughter animals (USDA, 2013). The study by (Holland et al.) also found, that all the slaughtering facilities in Tennessee did not slaughter a mix of animals and concluded that, this would prove a challenge to value-added meat entrepreneurs in the setting up of their businesses in some locations. A recent study has however shown that there are a high number of custom meat processing facilities that are not necessarily USDA-inspected (Bruch, 2010). The availability of these facilities provides meat goat producers with the needed incentives to add value to their products in to increase their market share and also draw in new customers.

### **References**

Bruch, M.L. (2010). List of custom meat processing facilities in Tennessee. Center for Profitable Agriculture publication no. CPA Info 171.

Carr, C., Eubanks, L., Dijkhuis, R. (2011). Custom and retail exempt meat processing. Florida cooperative extension service publication no. AN204, Gainesville, Florida.

Holland, R., Dalton, A., Hubbs, S. (2003). A review of USDA- inspected livestock slaughtering facilities in Tennessee. University of Tennessee Extension publication no. PB1727, Knoxville, TN.

Madruga, M. S., Bressan, M. C. (2011). Goat meats: Description, rational use, certification, processing and technological developments. *Small Ruminant Research* 98:39-45.

Pinkerton, F., L. Harwell, W. Drinkwater, and N. Escobar. (1994). Consumer demand for goat meat. Oklahoma cooperative extension service publication no. m-04, Langston, OK.

### **Factors Influencing Ethnic and Immigrant Demand for Goat Meat in Tennessee**

*Damilola Giwa, Enefiok Ekanem and Mary Mafuyai-Ekanem, Tennessee State University*

### **Factors Influencing Ethnic and Immigrant Demand for Goat Meat in Tennessee**

**Damilola Giwa and Enefiok Ekanem**

**Tennessee State University, Nashville, TN**

**Mary Mafuyai-Ekanem**

## **Introduction**

The meat goat industry is the fastest growing animal industry in the United States. Previous studies have considered it to be an infant industry with substantial growth potential. There are numerous breeds of goats and they have been categorized according to their ability to produce meat, fiber, and dairy products. The consumption of goat meat has become increasingly popular in the United States with most of its demand for goat meat steaming from the Southeastern region. Data from the USDA, (2011), showed that Tennessee is ranked second in goat meat production with the total number of 115,000 meat goats as of January 1, 2011. However, the growth in Tennessee's meat goat industry can be attributed to a growth in the U.S. ethnic population and the desire for a healthy diet. Over the past decades, the United States has experienced an influx of diverse ethnic population. Majority of these immigrants are Hispanics, Asians, Africans and people from the Caribbean. These groups of immigrants have a dietary preference for goat meat. In addition to that, the tendencies to retain food preferences and the persistence in maintaining cultural practices have increased the demand for goat meat.

However, the type and weight of carcass purchased also differs among these immigrant populations. Hispanics tend to prefer young kids weighing 15-25 pounds live weight or young goat that yield a 25 pound carcass. Muslims prefer a slightly heavier goat than Hispanics; they consume male goats that weigh about 70 pounds live weight. People from the Caribbean, Africans, Jamaicans and African Americans have a preference for mature goats. An additional source of demand comes from health conscious consumers who now consume goat meat as a gourmet food item and because of its nutritional attributes. Goat meat is said to have better nutritional attributes than other red meats. It is lower in cholesterol, fat, and high in protein and iron. In spite of the increase in consumption, the United States does not have an adequate supply of goat meat to meet the increasing demand for the product. In 1991, goat meat imports rose from 1,361 metric tons to 1,749 metric tons exceeding exports which were 709 metric tons thereby making the United States is a net importer of goat meat.

## **Objectives**

The main objective of this paper is to identify the factors that influence demand and the constraints that reduce the consumption of goat meat by the ethnic and immigrant population in Tennessee.

## **Results**

The following section reports on the findings from a review of secondary literature. A study by Nelson and Liu (2005) examined the demand for goat meat and its potential increase in Southern states. The study analyzed data from an extensive consumption survey that sampled a maximum of 257 household respondents in each of the Southern states. The study identified that socioeconomic, demographic and geographic factors influenced previous consumption and willingness to consume more goat meat. Econometric models were used to estimate goat meat demand. Results generated from the current demand model indicated that household income influenced consumption patterns and low-income households were more likely to demand goat meat than high-income households. The results of the increased demand from new consumer model showed that demographic and geographic variables plays an important role in goat meat consumption. However, there is increased consumption of goat meat among new goat meat consumers in each of the Southern states. The results of the seasonal demand model showed that consumers who ranked meat prices as important tend to adjust consumption pattern in different seasons.

Additionally, high-income households consumed more goat meat seasonally than low-income households. The result of the occasional demand model is similar to that of the seasonal demand model. Here, impacts from race, gender, and age were observed. The observed results showed that Hispanics and other multi-racial populations are more likely to consume goat meat occasionally than other ethnic groups. Additionally, young consumers tend to consume goat meat occasionally. The study concluded that ethnic and immigrant population is the key factor in goat meat consumption. Although the demand for the product still remains seasonal and occasional, the willingness to buy more goat meat by current goat meat consumers and the possible entry of new consumers into the goat meat market tends to increase the demand for goat meat. Race, age, real income and the consumption of other meat among others are factors influencing the demand for goat meat. Although the demand for goat meat tends to be seasonal and consumption is centered on religious and cultural holidays, previous research suggests that the demand for goat meat is influenced by consumers' income, geographic factors, ethnic and religious practices, age and education.

### Conclusion

The goat meat industry in the United States is still in its infancy stage with a fast expanding market. However, the need to adopt a cost effective method in goat production is a necessary condition for increased output. Additionally, more emphasis should be placed upon product quality. Due to the persistence in maintaining cultural practices, the demand for goat meat among these ethnic and immigrant population is expected to be relatively inelastic (Nelson & Liu, 2005; Simons, 2012; Pinkerton, Harwell, Drinkwater, & Escobar, 1994). However, it is projected that by 2025, the U.S. population will increase by 44 million due to the influx of ethnic and immigrant population, many of which will have a dietary preference for goat meat (Knight, 2005). Therefore, further increase in the demand of goat meat is expected as the size and purchasing power of the ethnic and immigrant population grows (Okpebholo & Kahan, 2007). Goat producers servicing the ethnic market must adopt management skills that will optimize the profit of their operation.

### References

- Gipson, T. A. (1999). Demand for Goat Meat: Implication for the Future of the Industry. *14th Ann. Goat Field Day* (pp. 23-30). Langston: Langston University Goat Research Extension. Retrieved from Langston University Goat Research Extension: [http://www.luresext.edu/goats/library/field/goat\\_meat\\_demad99.htm](http://www.luresext.edu/goats/library/field/goat_meat_demad99.htm) [not in text]
- Knight, E. (2005). Evaluation of Consumer Preferences regarding Goat Meat in Florida. Florida: University of Florida, Gainesville, FL?
- Nelson, M. C., and Liu, X. (2005). Demand Potential for Goat Meat in Southern States: Empirical Evidence from a Multi-State Goat Meat Consumer Survey. American Agricultural Economics Association Annual Meeting, [Do not italicise]Providence, RI
- Okpebholo, F., and Kahan, T. (2007). Opportunities and Challenges for Developing Small Ruminant Systems . Tallahassee, FL Official newsletter of the Florida Meat Goat Association.
- Pinkerton, F., Harwell, L., Drinkwater, W., & Escobar, N. (1994). [http://www2.luresext.edu/goats/library/fact\\_sheets/m03.htm](http://www2.luresext.edu/goats/library/fact_sheets/m03.htm)
- Simons, M. (2012). Kentucky State University Cooperative Extension Program. <http://www.extension.org/pages/62566/marketing-meat-goats-the-basic-system>

Solaiman, S. G. (2007, October). *Future outlook of meat goat industry for the U.S small farms*. Retrieved from <http://www.agmrc.org>:  
[http://www.agmrc.org/media/cms/USGoatProductionFinal\\_E1367962C32D1.pdf](http://www.agmrc.org/media/cms/USGoatProductionFinal_E1367962C32D1.pdf)

## **Meat Goat Enterprises as an Alternative Source of Income for Tennessee Small Farmers**

*Azubuike Ezeadum, Enefiok Ekanem and Mary Mafuyai-Ekanem, Tennessee State University*

### **Meat Goat Enterprise as an Alternative Source of Income for Tennessee Small Farmers**

**Azubuike Ezeadum**

**Enefiok Ekanem**

**Tennessee State University, Nashville, TN**

**Mary Mafuyai-Ekanem**

**LaRun & Associates, Greensboro**

#### **Background**

Raising livestock has emerged as a lucrative system of farming in the United States. Primarily meat goat production has become today's favourite. Compared to other livestock, goats are easier to manage and cheaper to maintain. They require less medical attention and less environmental protection. They also require less acreage for start-ups, minimum investments. Not much supplemental feeding is needed since goats like shrubs and they feed on grass, helping in landscape management. Goats are raised for variety of reasons; examples are: Angora, Cashmere goats for fiber production; Alpine, Nubian goats dairy products such as milk, cheese; Boer, Kiko goats for meat production. Fiber goats account for 6 percent of all goats in the United States, while milk goats account for 12 percent, and meat (plus other) goats account for 82 percent (Figure 1). Goat milk products increased slightly from 2007 to 2011, while fiber and meat production were relatively stable. Goats are also used for Agro-tourism, pets, and other purposes. Goats are reproductively efficient with a gestation period of 150 days on average when compared to cattle which is about 285 days on average.

In recent years, meat goat production in the United States has been on the increase as well as goat meat consumption. U.S. Census of Agriculture (2007) recorded a total of 3,140,529 goat inventory in the States, a 24 percent increase over 2002 Census (Table 1). This implies that more farmers have moved into goat business haven seen the numerous opportunities that lie within. Also, according to Food and Agricultural Organization (FAO) trade figures in 2007, imports of goat meat (chevon) increased to 10,166 metric tons valued at \$37.047 million from 142 metric tons valued at \$.256 thousand in 1987.

Figure 1: Distribution of goat inventory by type of goat, January 1, 2011

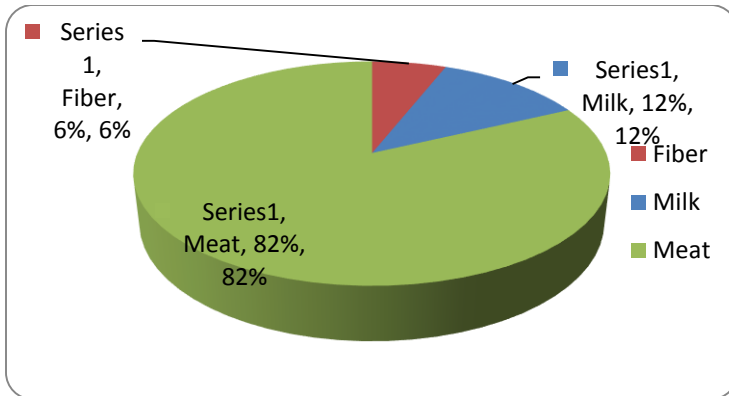

Source: USDA National Agricultural Statistics Service 2011

Table 1: U.S. goat inventory 2007

Goat	Number	Percent
Fiber	204,106	6.4
Milk	334,754	10.7
Meat	2,601,669	82.9
Total	3,140,529	100.0

The market for meat goat is proliferating as a result of the increasing number of immigrants who prefer goat meat to other red meats. In 2004, more than 32.4 million of the population in the United States or about 12 percent, were foreign born. These populations are Asians, Africans, Caribbean, and people from the Middle East. These numbers are expected to grow annually, and thus, there will be more market for goat farmers. Increase in ethnic household disposable income is another factor contributing to increase in goat meat consumption. For the health-conscious consumer, goat meat is proven to have health benefits that surpass beef, pork, or chicken. Research has shown that goat meat contains fewer calories, less fat, and still good protein content (USDA, 2001). The U.S. goat industry is still developing since goats are not popular in this part of the world. Most goat populations are scattered across the southern United States, with Texas leading the chart. Texas has the highest number of goats due to its dry climate and suitable forage species. Tennessee ranks second in the number of meat goats in 2007 (Table 2). The total number of meat goats in Tennessee as of January 1, 2012, was 121,000 head (USDA, Tennessee farm facts, 2012). This number increased by 4,000 head from 2007 results. Milk goats were 9,000 head, which is an increase of 1,500 head from 2011. The above statistics can be justified by the diversity of the state's population. U.S. Census Bureau of 2010 estimated the population of Tennessee to be 6,356,897 inclusive of 288,993 foreign born immigrants. A study conducted in Botswana by Panim and Mahabile (1997) revealed that goat enterprises in the surveyed region provided a return of 34 percent on capital invested. Also, it contributed 15 percent to total household income of the surveyed farmers.

## **Objectives**

The objectives of this paper are to: (1) review the literature on the role of goat production as an alternative enterprise for small farmers in Tennessee, (2) develop a profile for a successful goat enterprise model for Tennessee small farms, and (3) examine how meat goat producers develop strategies that help promote networks in different areas of their operations.

## **Methodology**

A mail questionnaire was used to collect information from Tennessee meat goat producers. Goat producers belonging to various meat goat associations were specifically targeted for recruitment as participants. This is the first of a two-part strategy to collect information needed to complete this research. In the second survey, producers from all counties in Tennessee will be selected; however, actual participation will be restricted to producers with at least five head of goats. Data will also be collected by telephone, personal interviews and use of “Survey Monkey. “ Also surveys will be sent by mail to goat producers who subscribe to the mailing list maintained by the Tennessee Extension small ruminant specialist. Information regarding farm size, herd size, input and labor costs, output prices, medical expenses, income, etc ., will be collected. The number of animals and quantities of their products sold, consumed, or given away will also be assessed. The returned data will be analyzed using standard statistical methods with Microsoft Excel, SPSS, and Stata. Sampling errors will be calculated to produce reliable statistical estimates.

## **Results**

Since this is an on-going research, the results from the first part of data collected will be reported. Observations from data collected, so far, will allow for conclusions that are partly based on previous research conducted elsewhere. Since the literature revealed an increasing immigrant population and an increasing demand for goat meat, it is expected that the goat is indeed a lucrative system of livestock production. Goat meat and cheese are gaining popularity among Tennessee farmers as more farmers move into the business, either for fun or for economic gain. Findings from the survey conducted as part of the current research is briefly discussed in this section. Expectations of industry trend may adequately predict expectations of profits for producers in Tennessee. Three specific questions were analyzed: (1) what has been the trend in the profitability of your goat operation in the last 3-5 years? (2) With respect to potential growth, what do you expect of your business within the next 5 years? (3) What percentage of your household income comes from selling goats? The results showed that farmers were expecting moderate to strong gains in business expansion and profitability. There was an increase in total farm profit for most of the farmers. (Table 3) Also, these profits were compared to total household income of the surveyed farmers. Goat enterprises contributed a sizeable percentage to farmers’ household income in 2011 (Table 4).

## **Conclusion:**



Goat meat is a healthy type of meat with lesser calories and lesser fat content s. The more people know about this, the more likely they are going to switch to goat meat, and that means more market for it. There is not much research on meat goat production, because it is not as common as beef, pork or poultry. This research is to explore the economic benefits coming from goats as a whole and to encourage farmers who have less acres of land to invest in goat farming. Thus, it will require government involvement to assist the small farmers, and help develop more policies to guide and support them as well as potential goat farmers.

Table 2: U.S. top ten states for number of meat goats in 2007

	Meat Goats	% of total	% of 2002
United States	2, 400, 000	100	124
Texas	1, 090, 000	45.4	116
Tennessee	117, 000	4.9	109
California	100, 000	4.2	163
Georgia	95, 000	3.9	144
Oklahoma	81, 000	3.4	110
Kentucky	74, 000	3.1	120
North Carolina	70, 000	2.9	119
Missouri	68, 500	2.8	183
Florida	65, 000	2.7	180
Alabama	48, 000	2.0	101

Source: USDA, NASS Overview of Sheep and Goat industry; September, 2007

Table 3: Farmer profits increase from selling goats and goat meat

Potential Growth or Decline in Business	Farmers	Percent
Major growth	7	15.9
Major decrease	2	4.5
Moderate increase	24	54.5
Stay the same	5	11.4
Don't know	6	13.6

Total	44	100
-------	----	-----

Table 4: Contribution of goat enterprise to farmers' total household income in 2011

Household Income	Frequency	percentage
0% - 24%	41	93.2
25% - 49%	2	4.5
50% - 79%	0	0.0
75% - 100%	1	2.3

## References

Bhaskar R., Scopiliti M., Hollmann F. and Armstrong D. (2010). Plans for Producing Estimates of Net International Migration for the 2010 Demographic Analysis Estimates. Population Division, U.S. Census Bureau. Working Paper No. 90

Brandt's & Hoach's Alpine Dairy Herd. 2008. Available online at:  
<http://www.brandtsandhoachsalpines.com>

Community American Reports Survey (2012). "The Foreign-Born Population in the United States: 2010"

Panin A. and Mohabile M. (1997). Profitability and household income contribution of small ruminants to small-scale farmers in Botswana. *Journal of Small Ruminant Research* 25:9-15

Pinkerton, F. and K. McMillin. (2006). "Meat Goat Production Economics": The Influence of Annual Doe

Maintenance Cost and Reproductive Performance on the Break-Even Selling Price/Pound of Slaughter Kids. Proceedings of the 2006 Tennessee Meat Goat Field Day. University of Tennessee Extension and Tennessee State University Cooperative Extension Program. Nashville, Tennessee.

Spencer, Roberts. (2008). "Overview of the US Meat Goat Industry" Alabama Cooperative Extension System.UNP-104, December 2008.

USDA, National Agricultural Statistics Service. (2002, 2007). Census of Agriculture, NASS, Washington, DC

USDA, National Agricultural Statistics Service. (2007, 2011). Overview of U.S. Sheep and Goat Industry, NASS, Washington, DC

United States Department of Agriculture, National Agricultural Statistics Service. (2012): Tennessee farm facts.

US Census Bureau. 2011. Tennessee Quick Facts: U.S. Department of Commerce, Economics and Statistics Administration. Washington, DC. Available at: <http://www.census.gov>.

USDA. 2001. Nutrient Database for Standard Reference, Release 14, Washington, DC

## **Session 2 O**

**Track/Session: Program Planning and Implementation/Enhancing Farm Opportunities**

**Organic Certification: History, Roles, and Process**

*Sarah Brown, Oregon Tilth, Corvallis, OR*

### **Organic Certification: History, Roles, and Process**

**Sarah Brown**

**Oregon Tilth, Corvallis, OR**

#### **Introduction**

Oregon Tilth Certified Organic (OTCO) has been offering organic certification services to the industry for over 30 years. Helping to develop the National Organic Standards of USDA, Oregon Tilth was one of the first to gain accreditation and begin offering organic certification under USDA organic regulations. Oregon Tilth offers certification services to producers, manufacturers, food handlers and

more, both nationally and internationally. Oregon Tilth is one of the largest certifiers in the country and (OTCO) is an internationally recognized symbol of organic integrity.

### History of Organic Certification

Date	Event
1990	U.S. Congress passes Organic Foods Production Act (OFPA) as part of Farm Bill of 1990. Authorization for National Organic Standards Board.
1998	USDA publishes proposed National Organic Program standards, allowing use of GMOs, sewage sludge, and irradiation. Consumers respond with over 275,000 comments
December 2000	USDA publishes National Organic Program (NOP) Final Rules (7 CFR Part 205).  Describe standards, procedures, labeling provisions, accreditation of certification agents and enforcement.
October 2002	Full implementation of the National Organic Program (NOP).

USDA’s NOP defines organic as “a labeling term that indicates that the food or other agricultural product has been produced through approved methods that integrate cultural, biological, and mechanical practices that foster cycling of resources, promote ecological balance, and conserve biodiversity. Synthetic fertilizers, sewage sludge, irradiation, and genetic engineering may not be used.” The federal standards have led to more consistent usage and definition of the term “organic”. Consumers can be assured that the organic label means the same thing, regardless of where they are in the country. Organic farmers, recognizing a higher premium for food grown to these standards, have consistently increased in number since the NOP began.

**Figure 1 shows the number of USDA Organic Certified Operations.**

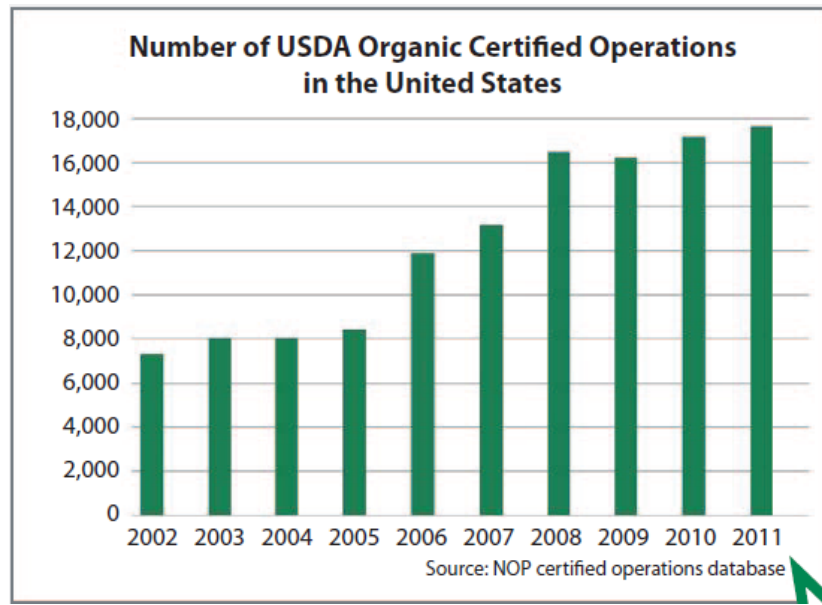

### **Roles in Organic Certification**

- The National Organic Standards Board
  - 15 member advisory board to the Secretary
  - Four farmers, two processors, one retailer, one scientist, three consumer/public interest advocates, three environmentalists, and one certifying agent.
  - Assist in developing standards for substances and materials
  - Advise on other aspects of implementing the NOP
  - Host two annual public meetings
- The National Organic Program
  - Accredite certifying agents (domestic and foreign)
  - Responsible for compliance and enforcement
  - Disseminate new and amended regulations
  - Collaborate with foreign governments
  - Does NOT certify operations
- Certifying Agents
  - Third-party certifiers of NOP regulations
  - Follow procedures established in NOP regulations
  - Maintain accreditation
- Inspectors
  - Work for certifying agents

- Conduct annual on-farm inspections of organic operations
- Organic producers & handlers
- Any operation that produces or handles crops, livestock, or other agricultural products that are intended to be sold as “organic” must be certified.
- *Exemption:* A production or handling operation that sells agricultural products as “organic” but whose gross agricultural income from organic sales totals \$5,000 or less annually is exempt from certification and from submitting an organic system plan, but must comply with the applicable organic production and handling requirements.

## **Process of Organic Certification**

**(As described by USDA’s NOP)**

**To become certified, an operation must apply to a USDA-accredited certifying agent. They will ask for information, including:**

- A detailed description of the operation to be certified.
- A history of substances applied to land during the previous 3 years.
- The organic products grown, raised, or processed.
- A written Organic System Plan describing the practices and substances to be used.

Organic Certification Process:

- Producer or handler adopts organic practices; submits application and fees to certifying agent
- Certifying agent reviews applications to verify that practices comply with USDA organic regulations
- Inspector conducts an on-site inspection of the applicant’s operation
- Certifying agent reviews the application and the inspector’s report to determine if the applicant complies with USDA organic regulations
- Certifying agent issues organic certificate

## **Resources**

- USDA National Organic Program (NOP), [www.ams.usda.gov/OrganicInfo](http://www.ams.usda.gov/OrganicInfo)
- Oregon Tilth, [www.tilth.org](http://www.tilth.org)
- USDA NOP Cost-share, <http://www.ams.usda.gov/AMSV1.0/NOPCostSharing>

## **Bridging the “Digital Divide” of Small Farm Families and Limited-Resource Farmers Through Computer Literacy and Technology**

*Courtney T. Owens, Cooperative Extension Program, North Carolina A & T State University*

### **Bridging the “Digital Divide” of Small Farm Families and Limited-Resource Farmers Through Computer Literacy and Technology**

**Courtney Owens**

**North Carolina A&T State University, Greensboro, NC**

#### **Introduction**

In general, farmers have been slow to adopt and benefit from technological innovations like personal computers. The reasons for this late adoption of technology include the cost of the computer, time required to learn to use it, and lack of knowledge about its capabilities; technology adoption is also dependent upon level of education of farmers and size and type of farming operation (Bowen and Escolme, 1990; Perry and Johnson, 1999). A majority of small farmers still experience these challenges today in the agriculture industry. To further explain the “digital divide” and the effects that it has on small-scale farming, researchers have identified the following factors: 1) small-farm educational programming; 2) small-scale agricultural enterprises and production practices; 3) alternative marketing; and 4) risk management. Furthermore, marketing, value added processes, enterprises that generate income in several ways (e.g. tourism plus direct sales, etc.) as well as many of the “sustainable community” or “smart growth” issues address economic viability directly (Perry, and Johnson, 1999).

Farmers need these necessary tools to adopt new technologies to compete in the overall global marketplace. Many agricultural operations are short on information technology (Findlay, and Zabawa, 1993). For example, less than 20 percent of farms throughout the southern states purchase agricultural inputs over the Internet (Figure 1), or conduct marketing activities over the Internet (Figure 2). However, to sustain their agribusiness, it is imperative for all small-scale and/or limited-resource farmers to adopt current computer literacy tools.

**Figure 1: Purchase Agricultural Inputs Over Internet - 2011**

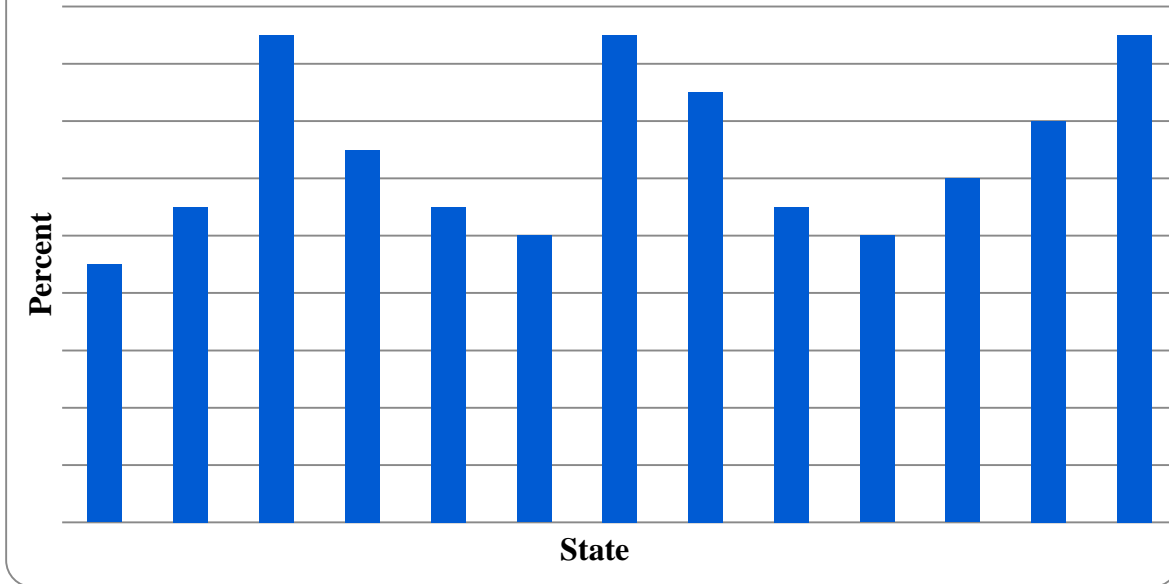

**Figure 2: Farmers Conducting Agricultural Marketing Activities Over the Internet - 2011**

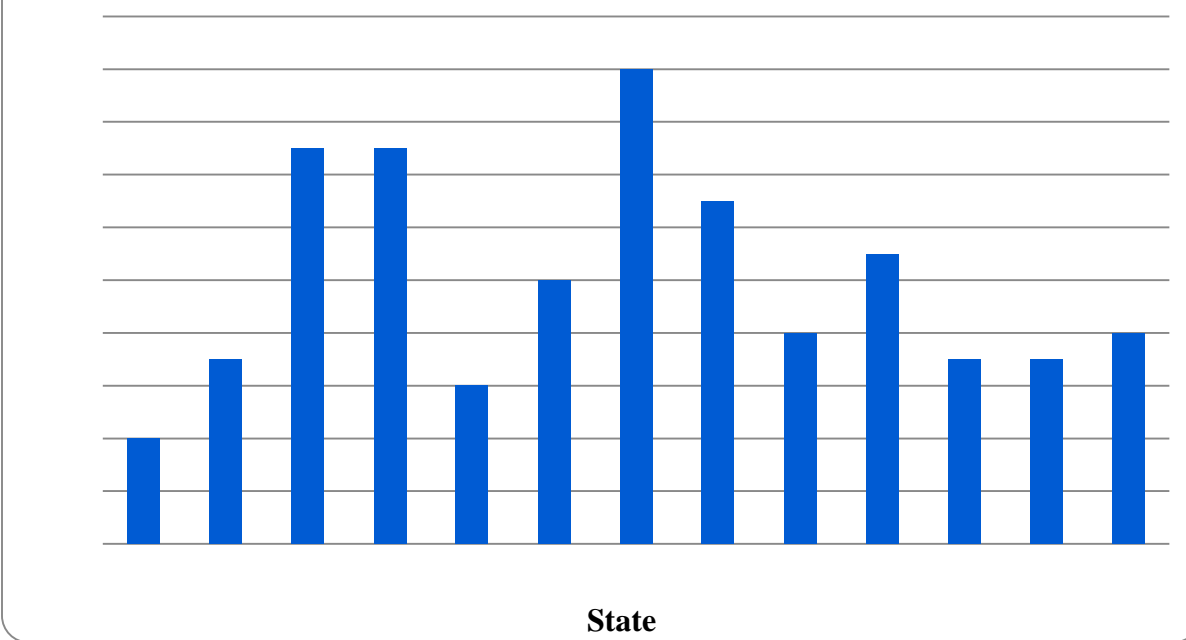

The Farmers Adopting Computer Technology (FACT) program, created in 1998 by The Cooperative Extension Program at North Carolina Agricultural and Technical State University as part of a 2501 Outreach Project, provides technical education and training resources for small, part-time and limited-



resource farmers who seek to improve their computer skills and to better manage their farm operations. In 2003, the FACT program expanded with a partnership between NC A&T State University and selected North Carolina Community Colleges to meet the computer technology needs of limited-resource farmers.

### Goals and Objectives

The goals of this program are to introduce the computer as an updated method of keeping farm management records, teach farmers how to maintain accurate farm records, teach farmers how to reach new markets and suppliers, and to support the acquisition of affordable computers by small-farm households.

The following objectives support the program's goals: 1) Assist farmers and their families through training to develop computer skills including spreadsheet and word processing software use as well as e-mail and Internet use. 2) Develop partnerships with North Carolina Cooperative Extension, local Small Business Centers, and Human Resource Departments at Community Colleges to help train limited-resource audiences. 3) Promote participation of small and limited-resource farmers in computer training offered at community colleges and other training sites. 4) Improve small farm families' decision-making skills through computerized programs. 5) Increase small farmers' competitiveness in the marketplace through the use of technological innovations.

### Justification

The FACT Program is a performance-based learning tool that uses specific trainings to develop and heighten computer literacy among small-scale farm families to improve their record keeping and farm business management skills. The primary audience is small scale and limited-resource farm families across North Carolina. Computer illiteracy, low levels of education, lack of managerial ability, and lack of electronic buying and marketing skills are all issues that have reduced some North Carolina small farmers' ability to obtain loans and legal settlements. Information from a survey and field observations revealed "that farmers had poor record keeping/filing systems and kept receipts and records on the dashboards of trucks, under truck seats, shoeboxes, paper bags, etc." Also, as a result of economic hardships, some farm families are forced to seek off-farm employment to sustain their farming operations. Some of these jobs required some level of computer literacy and technology skills.

### Program Structure

The FACT program name was altered in 2010, changing the "T" from "training" to "technology," to reflect a shift in both purpose and training methods. Individual one-on-one "training" was supplanted by broader-based classroom instruction offered through community college partnerships. This shift enabled the FACT program to reach a greater number of farmers and fulfill the goal of showing farmers how technology positively affects their bottom lines.

In 2011, The Cooperative Extension Program at A&T teamed up with the NC Community Colleges State Human Resource Development Director to restructure the course and hours for the FACT program. Two new courses were created: Technology Awareness and Economic Literacy. These courses provide employability skills training for unemployed and underemployed farmers. The curriculum framework is designed to help participants understand real-life economic concepts and economic ways of thinking in agriculture that will enable them to make better informed decisions to sustain profitable farms. Program participants receive a certificate of completion at the end of the 88-hour course schedule. Farmers can take classes twice within a five-year period. The cost of the program is provided at low cost or no cost to qualifying participants.

## Impacts

Fifteen (15) of the farmers completing the FACT program have gone on to serve as North Carolina Small Farmers of the Year, an annual recognition bestowed by The Cooperative Extension Program at NC A&T State University. From 2003-2011, farmers received instant savings averaging from \$120 for one course to \$480 for four courses, depending upon the number of classes taken during the program. There is a 31 percent increase of farmers in North Carolina acquiring computer literacy skills since 2009. In 2009, there were 467 farmers in the program. To date, we have 614 farmers in the program. The number of small farmers utilizing the general store website at North Carolina Department of Agricultural & Consumer Services to market their agricultural goods and services to maintain a web presence for Internet marketing also increased.

## Concluding Remarks

There continues to be an increase in small-scale, limited and part-time farmers participating in computer technology. Farmers are now venturing out to become more computer savvy marketing their agriculture product on social media and other online markets. USDA studies show that there is a constant need for farmers to examine these new technologies. The FACT program will continue to educate and innovate new techniques to improve Extension programming for socially disadvantaged farm families.

## References

- Bowen , Blannie E. and Escolme, Kathleen M. (1990). "Computer education of farmers." *Journal of Agricultural Education*, XXXI: 39-45
- Findlay, H.J. Zabawa, R., Morris C.E. and Oben, M. (1993). Computer awareness among limited-resource farmers. *Journal of Extension* [Online]. 31(1) Available at <http://www.joe.org/joe/1993spring/a8.html>.
- Perry, J. and Johnson, J. (1999). Off-farm-Income, Technology Adoption, and farm Economic Performance/ERR-36 Economic Research Service/USDA
- Taylor, Mark T., Hoag D.L., and Owen, MB. (Year). "Computer Literacy and Use." *Journal of Extension* [Online]. xx(x) Available at <http://www.joe.org/joe/>

## Session 2 P

**Track/Session: Research and Extension Priorities/Beginning Farmers**

### Sustainable Development

*Jennifer Taylor, College of Agriculture and Food Sciences, Florida A & M University*

Sustainable Development

Jennifer Taylor  
StateWide Small Farm Programs  
College of Agriculture and Food Sciences  
Florida A&M University,  
Tallahassee, FL

## **Introduction**

A key issue within global agricultural research and development is the need to positively focus on the sustainable development of small farmers, resource-poor farmers, and their families. Though these farmers make up to 90 percent of the world's farmers, often they have not had equal access and participation in programs and training designed to assist large producers and agribusinesses.

Generally, agricultural research and Extension have sought out medium and large farmers thought more successful, innovative, and readily able to adopt technology and contribute to growth and development. A recent USDA Census indicated that about 91 percent of all farms in the United States are small farms. Small farms represent over 90 percent of all farms in Florida.

### **FAMU StateWide Small Farm Program**

It is important to ensure local food security with agricultural management strategies that enhance sustainable agroecological production, encourage local food systems, and embrace the benefits of local and global small farm populations. Florida A&M University's (FAMU) StateWide Small Farm Programs is an active participatory capacity building program designed to assist and equip underserved farming populations and their families toward a thriving sustainable development. The Program uses a participatory, multidisciplinary integrated systems approach to provide relevant education, hands-on training, and technical assistance to underserved farming populations.

The overall goal of FAMU StateWide Small Farm Programs is to equip small farm populations toward a thriving sustainable development. FAMU StateWide Small Farm Program works with farmers and their surrounding communities to enable the capacity to change. As a result of the holistic approach, there are growing numbers of local small farms and garden-farm leaders producing food sustainably using agroecological organic farming methods, and providing their produce directly to the community through local markets and community-supported agriculture operations (CSAs). Several small local community markets were developed and are affiliated with this sustainable development program. Capacity building sessions provide participatory education and hands-on training, technical assistance in specific relevant areas. Workshops and learning farm tours encourage awareness of local food resources, healthy eating, community food networks, and the delights of a local sustainable table. Several of the capacity building sessions provided include:

- Integrated Agricultural Systems Workshop - information and examples of hydroponic systems, organic hydroponic management strategies, organic integrated management for greenhouses and high tunnels, and farm tours of hydroponic heirloom tomato small farm. Hands-on session. On-farm workshop.

Sustainable Living Fruit production and Management Workshop- information and hands-on training in growing Zone 8 fruit, including field preparation,

- Pest management, grafting, etc.; organic fruit including blueberries, pears, peaches, blackberries, and strawberries, etc. On-farm workshop.
- Transitioning to Organic Production Workshops- information and training on organic production and management system and strategies that support the agro-ecological system, organic system plan, USDA regulations, farm tour, etc. On-farm workshop.
- Eco-farms are the Viable Solution Workshops- information on successful eco-farm management systems, organic method strategies, farmer leadership, and identification of goals, possible solutions, and networking. On-farm workshop.
- Farming in Small spaces, examining Urban farming- information to encourage building sustainable innovative communities centered about integrated agro-ecology urban farming systems, including concepts of aquaponics, alternative energy, compost, vermiculture and community support. Hands-on workshop.
- Sustainable Living: How to control squash bugs and other pests- technical assistance and organic integrated pest management preventative strategies to control insect pests and disease. Hands-on training collaboration with USDA's Agricultural Research Service On-farm workshop.
- Sustainable Living: Healthy Meat Systems Workshop- farmer-led participatory discussions on organic pasture management of beef cattle, sheep, goat, and poultry, and sustainable ranch tour. On-farm workshop.
- Farmer Nutrition Program- required information and training for farmers interested in participating in the Department of Agriculture and Department of Health Program Food Coupon Program. Program: Farmer participants receive certification, which allows farmers providing produce at farmer's market to receive coupons from customers. Allows customers to save fuel, purchase locally grown, organically grown produce, and encourages healthy sustainable living for communities that may not otherwise have access.
- Learning farm Tours – On-farm learning for participants; builds awareness of local food resources, enables community to meet local small farmers, and encourages interest for beginning farmers. Participants included students, farmers, and public/community.
- Teaching and Learning: Developed and implementing an integrated learning paradigm focusing on participatory capacity building strategies that encourage small local sustainable organic methods farms and encourages the local community food systems. Identified issues/needs, developed outcome/solution, relevant content, alternative strategies, and evaluation: Developed and implementing the Growers' Market

Model and Approach for underserved farming populations. A participatory value-added alternative education - market strategy. The community markets served as educational networks providing consumer information about local food resources: local farms/farmers, local eating/healthy eating, building your local sustainable table, and local farm strategies. The farmers receive assistance in farmer-to-consumer setting. Educational workshops and educational cooking demonstrations were held during market hours for consumers and farmers. Additionally, a primary focus is to provide a local resource for small farmers to provide fresh sustainably grown and organically grown produce to the community.

- Developed and implementing Innovative Biofuels Research and Demonstration Sustainable Small Farm Model: The Whole Farm Sustainable Small Farm Biofuels Project began in 2006 with capacity building sessions that provided information and hands-on training in making biodiesel from waste vegetable oil. This is a participatory community project. The project serves as a sustainable small farm biofuels model for the region. Learning sessions on how to grow oil seed crops and press to make biofuels have also been provided to the farming population and community. The farm runs off of biodiesel including all farm equipment, tractors, and farm vehicles. This knowledge and skill can be used in the design of sustainable innovative communities and is important as we examine the alternative energy mix capable of sustaining small farms and communities. Recently, in 2012, when our area suffered severe flooding and power outages for several days, the small farm alternative energy demonstration project was able to power the whole farm off-of-the-grid.
- Leadership development- information and assistance to farmers interested in USDA programs, and grant opportunities.
- Interdisciplinary exchange, and academic and professional development. 2012 Florida State University Fellows Society Forum “Journey to the Table: A Discussion of the Food System,” participant. J. Taylor presented information on the FAMU StateWide Small Farm Program’s capacity building strategies used to equip small farm populations and their communities. <http://gradschool.fsu.edu/Fellows-Society>
- Participant/Speaker in the 2012 Leon County Sustainable Communities Summit. J. Taylor addressed global and local small farm development, FAMU StateWide Small Farm Program’s capacity building strategies to enhance sustainable development and encourage sustainable food systems.
- The United Nations General Assembly endorsed a decision to accredit several organizations to the 2012 United Nations Conference on Sustainable Development. These accredited organizations were found to exhibit the necessary attributes of an organization demonstrating expertise in an area of sustainable development relevant to the UN Conference. FAMU Statewide Small Farm Programs was one of the organizations that received distinction and accreditation to participate in the global 2012 United Nations Conference on Sustainable Development.

**Selected comments from participants follow:**

“I am particularly grateful for the opportunity to purchase fresh, organic produce grown by farmers in my community. Not only is there a wide assortment of fresh fruit and vegetables from which to choose, but also there are fresh eggs, herbs, freshly-baked bread. . .”

“How fortunate we are in Tallahassee to have such a marvelous resource in our community. Fortunate for those who want to buy locally-grown organic food for their families, and fortunate for the organic farmers to have a market place for selling heir food.”

"A wonderful program that touches and heals the community with health, diversity and a chance to change one's health for the better."

Several students from China, Libya, Kuwait, Brazil, Venezuela, Indonesia, and the United States participated in an on-farm learning session and farm tours reported, “. . . what a wonderful experience this was for . . . the students. It broadened my students' knowledge of organic farming and also gave them an opportunity to see small-farming in a realistic, interesting way. I do hope we can continue our collaborations in the future as it is mutually beneficial.”

"I personally got a lot of benefits after going to the farming areas and listening to some explanations from Dr. Jennifer Taylor. She delivered a new perspective of how to farm organic plants and getting benefits from the plants. . Therefore, if someday I want to grow organic vegetables in my own lawn, I can implement the basic principles of growing organics. I applied the experience on the farming area to my research paper as extra information. Furthermore, the experience actually gave me a good understanding of the real organic farming process. Before I go to the farming areas, I understood about organics only from articles or journals which are always some pros and cons about organics. "

"We have already used (built) the greenhouse construction which has been very beneficial for square foot gardening that we have chosen to use as well as container gardening. We now have 2 (two) greenhouse constructions in use."

“The farm tour was very important. We learned how to prune trees, also a lot about treating different diseases that affect plants. We will use all of the info we learned here today. We also learned how to graft; this is something I’ve always wanted to do.”

“I was in attendance at your workshop this weekend. I just wanted to take the time to contact you and express my sincere appreciation for facilitating such an awesome and informative workshop. I am new to farming and have recently reactivated my family’s property in Gadsden for the purpose of becoming an aquaculture farmer. Although I've attended a lot of meetings with regard to preparation and operation, your workshop has by far done the most as far as providing me with a visual representation of the functionality and potential success of aquaponics farming. All of the information was practical and easy

to understand, and we appreciated with reading materials to continue our education about aquaponics farming. Additionally, the visual aids (on-site greenhouse construction, the various aquaponics scenarios and the tomato greenhouse tour) assisted by actually showing me useful and successful examples of aquaponics farming.”

“Just wanted to reiterate how your work has changed my life. . . I have changed my entire vision and method of how to grow food using all organic procedures. We have implemented just about everything we learned, and already I have seen incredible results. This is the first term where we created (composted) our own dirt and fertilizers. The results are astounding. Last year, we were unable to produce spinach with our methods, I have posted a few pictures to show you what happened in just a few weeks this year when we used our own soil. . . Thanks again for your efforts. I know others have benefited as well.”

### **Success Story**

A local conventional farmer participated in our capacity building efforts and received information about organic farming strategies including how to convert from conventional farming to organic systems. The farmer gained knowledge and changed farming practices to organic farming system methods, including benefits of organics, seed selection, alternative field preparation, enabling beneficial insects, trap crops, pest management strategies, fertilizers, amendments, etc. The farmer began selling organic produce at the local market. The farmer developed several items that were provided under the Cottage Food Regulation. Success of these items and additional information enabled the farmer to build a licensed kitchen through which he produces products and provides them to local natural food stores, and continues to grow produce using organic methods and organic pest management strategies.

### **Conclusion**

We are still learning what works and how to engage our small farm populations, students and community toward a thriving sustainable development.

### **Sierra Nevada Foothills Beginning Farmer and Rancher Training and Networking Project: Methods, Successes, and Lessons Learned**

*Cindy Fake, Trina R. Filan and Roger Ingram, University of California Cooperative Extension  
Placer & Nevada Counties, Auburn, CA*

### **Sierra Nevada Foothills Beginning Farmer and Rancher Training and Networking Project: Methods, Successes, and Lessons Learned**

**Cindy Fake, Trina R. Filan and Roger Ingram**

**University of California Cooperative Extension**  
**Placer & Nevada Counties, Auburn, CA**

**Introduction**

The farmer and rancher population across the United States is aging, and the lack of a next generation of agriculturalists has become critical in many areas. Burgeoning local food movements have been accompanied by a resurgence of interest in farming and ranching by those with no production agriculture experience. Most of those currently getting started in agriculture do not have farm or ranch backgrounds. They need to learn basic skills and understand the physical, social, and economic environment in which farming or ranching occurs. As a result, beginning farmer training programs have become much more widespread in recent years. (Niewolny and Lillard, 2010; Ochterski and Frenay, 2010). A variety of beginning farmer and rancher training programs has emerged across the United States, many of them funded by the U.S. Department of Agriculture (Ahearn and Newton, 2009). These programs take a variety of forms; including classroom or online instruction, short-term hands-on learning, and long-term apprenticeship and mentoring projects (see Niewolny and Lillard, 2010, for a detailed examination of many of these programs).

Cooperative Extension programs throughout the United States have developed beginning farmer and rancher training programs. In California, the University of California Cooperative Extension (UCCE), in Placer and Nevada counties has been at the forefront in offering this type of programming. Over the years, UCCE Placer/Nevada has adapted its training to accommodate the wide variety of interests and needs of the beginning farming population in the region. This paper presents a case study of UCCE Placer/Nevada's Beginning Farming programs, which have been in operation since 2004.

The first section of this paper describes the beginning farmer and rancher population, as well as the status of agriculture, in Placer and Nevada counties. The second section describes the evolution of UCCE Placer/Nevada's Beginning Farming programming. The third section details the methods used in gathering the survey data and the results of our survey of beginning farmers. The final section will discuss the implications of our results and how they might shape the future of beginning farmer and rancher outreach in Placer and Nevada counties.

**Beginning Farmers and Ranchers in Placer and Nevada Counties**

Placer and Nevada counties are located northeast of Sacramento in the Sierra Nevada foothills and are home to a diversity of small farms and ranches. According to the 2007 Census of Agriculture (USDA, 2009), there are 2,178 farms and ranches in the two counties. The majority of farms and ranches are small-scale, with 78 percent of farms under 50 acres in size and more than 87 percent generating less than \$25,000 in annual sales. While total land in farming has declined, the number of small farms increased by 6.9 percent from 2002 to 2007.



The structure of farming in the foothills has changed over the last forty years, moving from large-scale, commodity-oriented farms toward smaller-scale, more diversified, scattered farms and ranches. These changes are primarily due to development pressures. Placer County was the fastest-growing county in California between 2000 and 2009 (ERS, 2010), and Nevada County has seen an influx of new residents in the last several decades. The burgeoning population has provided a ready market and demand for local products, while creating economic and operational difficulties for some producers because of the price and fragmentation of land.

The average age of a farmer in these counties is over 56 years. According to the 2007 Census of Agriculture (USDA, 2009), only 1 percent of farms in Nevada County and 3 percent of farms in Placer County are operated by someone under 35 years of age. Conversely, 39 percent of farms in Nevada County and 46 percent of farms in Placer County are operated by someone 60 years of age or older. Few of the younger generation of farm families are interested in continuing their farming/ranching operations. Given this generation gap, recruiting and training new farmers and ranchers are critical. Without a new generation with strong connections to the farming and ranching communities, the sustainability of agriculture in Nevada and Placer counties is in doubt.

According to the 2007 USDA Census of Agriculture data (2009), more than one-third of farmers and ranchers in Placer and Nevada counties have been farming for 10 years or less (38 percent and 36 percent, respectively). This qualifies them as “beginning farmers and ranchers,” under the USDA definition. Actual numbers are probably considerably higher. More than half of these beginning farmers and ranchers are considered limited resource because of the scale of their enterprises, limited off-farm income, and lack of investment capital.

Local agricultural production is diverse and includes fruits, nuts, vegetables, flowers, ornamentals, and a variety of livestock. The strengths of the area lie in this diversity; an involved agricultural community; and the flourishing direct market economy created by rapid population growth over the last twenty years. Despite these strengths, the future of local agriculture is uncertain due to development-driven land prices, an aging producer population, and lack of agricultural infrastructure.

The demand for local agricultural products is very high in this region, and direct sales are the primary source of income for small-scale growers. Area residents access local food through farmers’ markets, on-farm sales, Community Supported Agriculture operations, meat buyers’ clubs, restaurants, and retail outlets. The current supply of local agricultural products lags behind consumer demand. The lack of a new generation of farmers and ranchers means that supply will remain short of demand, unless new producers can be trained and provided with the tools to reach an economically viable scale of operations.

Finally, without a new generation of farmers and ranchers being trained on farms by family members, a great deal of knowledge is being lost. Most people getting started in agriculture are not from farming or ranching backgrounds, and lack basic agricultural skills. Beginning producers often lack the knowledge to choose crops or species, appropriate production skills, financial resources, in addition to practical experience. A number of studies show that many farmers, whether beginning or experienced, lack the

financial and business skills needed for success (Ibendahl et al., 2002; Griffith, 1991) and place great value on the cultivation of those skills as they build their operations (Trede and Whitaker, 1998; Suvedi et al., 2000).

Given this situation, it is imperative to train a new generation of farmers and ranchers; providing them with the tools they will need to succeed in competitive and ever-changing markets. Educational approaches emphasizing experiential activities for adult learners must focus on critical topics such as economic analysis and financial planning; and market analysis and growing for market in addition to hands-on production skills. A practical understanding of these is vital to developing the foundation on which these new agricultural businesses will be based. Training must include interactive, participatory presentations that include real world perspective from farmers and ranchers. Providing beginning farmer and rancher training is a key element of the UCCE Placer/Nevada mission.

### **UC Cooperative Extension Placer/Nevada and Beginning Farmers and Ranchers**

In 2007, a group of Placer County farmers, ranchers, and agricultural advocates, including UCCE farm advisors, formed the Placer Ag Futures Project with the goal of taking concrete steps to ensure the existence of a viable and sustainable agricultural community in the foothills in 30 years. Among the objectives established by the group was that of farmer training. In addition, the project identified mentoring and internship opportunities as key methods for knowledge transfer to a new generation of farmers and ranchers.

UCCE Placer/Nevada has offered targeted programming for beginning farmers and ranchers since 2004, expanding and intensifying efforts in 2008 in order to meet increasing demand. Programming includes crop production and livestock husbandry, business assessment and planning, small-farm economics, risk management, marketing and market analysis. Networking and mentoring opportunities that connect beginning farmers and ranchers to more experienced growers have become integral to the training over the past five years.

Over the years, curriculum and logistics have evolved to a 20-hour, 2-day intensive Beginning Farming Academy. The intensive course is favored by both participants and organizers because it involves a less extended time commitment. Since its inception, 223 would-be producers have participated in Beginning Farming training, and 19 percent have begun commercial operations.

There are several key elements responsible for the success of the Beginning Farmer training program offered by UCCE Placer-Nevada. The first element is reality-based training, focused on conditions in the Sierra Nevada foothills with local information and real examples from the agricultural community. The second element is the participation of experienced local producers as an integral part of the training team. The third element is an educational approach that is collaborative, participatory, and focused on helping beginning farmers and ranchers develop realistic expectations without dampening their enthusiasm.

Beginning Farmer training is developed and delivered by a team of two UCCE farm advisors, four to six experienced farmers and ranchers, and the general manager of the Foothill Farmers' Market Association. This partnership is the foundation for the success of the training. While team teaching can be complicated, the variety of perspectives and realistic view of small scale agricultural production in the foothills is critical for the neophyte producers. Producers share information on their own operations, including marketing and business strategies, as well as economic analyses.

UCCE's Beginning Farmer training is personal, participatory, and hands-on. Most training classes are limited to 15 participants so that each individual receives feedback from trainers and other participants on their plans and ideas. The training consists of a series of interactive presentations by members of the training team interspersed with discussion, opportunities to network, action planning, and visits to a local farm and a farmers' market for in-field and hands-on experiences. Participants are actively involved through presentations of homework assignments and peer-to-peer feedback. The effectiveness and appeal of this mix of learning opportunities for adult learners is supported by Strong *et al.* (2010), who found that reliance on lectures alone makes Extension programming unappealing to Extension clientele.

From the beginning, UCCE's Beginning Farmer training has had two major foci: marketing and business planning. The training highlights the importance of understanding marketing including market research, producing appropriate products for target markets, emphasizing quality rather than quantity, and selling the story as well as the product. Developing a realistic start-up plan, including a business plan, and really understanding what is involved in operating a small agricultural business are critical to success for new producers. This is critical because many new farmers focus on production and lifestyle considerations and do not look at their operations from a business perspective.

Crop production and livestock husbandry training is delivered through separate, but complementary on-farm/ranch workshops. The Academy is one component of a comprehensive program that offers an array of production, husbandry, risk management, and marketing workshops throughout the year. Annually, UCCE Placer/Nevada offers about 220 hours of training for Beginning Farmers and Ranchers.

Understanding small-scale farm economics is fundamental to the training. Participants learn the importance of "knowing their numbers," learning to analyze enterprises, and understand costs and returns. They are encouraged to develop realistic start-up plans, and seriously consider the long-term implications of capital cost decisions. The idea that profit is critical to a sustainable business is a cornerstone message, as well as understanding that the goal of making a profit does not mean one needs to sell out one's philosophical motivations for entering agriculture. Participants are also introduced to the concept of operational scale and its relationship to economic viability.

Fostering a connection and responsibility to one's agricultural community are also central to UCCE's training. Training is supported by a mentoring program, internship opportunities, networking breakfasts,

a listserv and regional workshops which encourage visits to other farms and ranches. The Foothill farming website at <http://ucanr.org/sites/placernevadasmallfarms/> also provides a wealth of relevant, information appropriate to foothill agriculture.

There are very few opportunities in the foothills for this type of training other than through UCCE Placer/Nevada, which is involved in most of the agricultural education available to beginning farmers and ranchers in Placer/Nevada. Producers from surrounding counties regularly attend UCCE's workshops and educational events because there is nothing similar available to them in their home counties, which often serve larger-scale commodity producers.

## Research Questions

We undertook a survey of Beginning Farming training participants for several reasons. First, we wanted to understand which aspects of the program have been particularly important in assisting beginning farmers and ranchers in reaching their goals. Second, we will continue to refine this training, and build it into the continuum of programming that serves both beginning growers and growers who are ready to scale up their operations. Thus, we wanted to know whether aspects of the training should be changed. Third, we wanted to characterize the Beginning Farming population in Placer/Nevada and learn about the status of their operations. Although we realize this characterization does not encompass the total beginning farmer/rancher population in these two counties, it does give us an idea of the progression of start-up operations and what aspects of the training are most useful to the new farmers and ranchers.

## Methods

The primary method used in this case study was an electronic survey distributed via an e-mail listserv of Beginning Farming participants from 2008 to 2012. After culling for redundant e-mail addresses and bounce-backs, the population sampled included 140 e-mail addresses, each of which may represent one or more beginning producers. This purposive sampling precludes a variety of statistical analyses (Ramsey and Schafer, 1997; Bernard, 2000) but does provide insights into the experiences of this segment of the beginning farmer/rancher population.

The survey was created and managed through Survey Monkey, an online survey construction and distribution engine. Numerical data were analyzed with simple statistics, and responses to open-ended questions were analyzed using textual analysis and data coding to pick out broad themes. The total survey response was 32 of 140 potential respondents, a rate of 23 percent. The survey completion rate was 22 of 32 respondents, or 69 percent. Self-selection bias was unavoidable because of the way the survey was structured, limiting the ability to generalize from these data. Despite these limitations, some interesting results were obtained that can inform future beginning farmer and rancher training and outreach. Information from participant evaluations from Beginning Farmer trainings from 2010 to 2012 will also be included in the discussion.

## Results

Neophytes in agriculture often are attracted to it for lifestyle or philosophical reasons, such as a desire to grow good food for people. Indeed, our survey data show that most respondents entered farming for just these reasons (Figure 1). Many people who think they want to start a farm or ranch operation are unprepared for the business, production, and marketing planning that must be done in order to successfully launch an agricultural enterprise. Many also have not considered the economics of running a small-scale operation and the infrastructure that is necessary to get a farm or ranch started (Ochterski and Frenay, 2010).

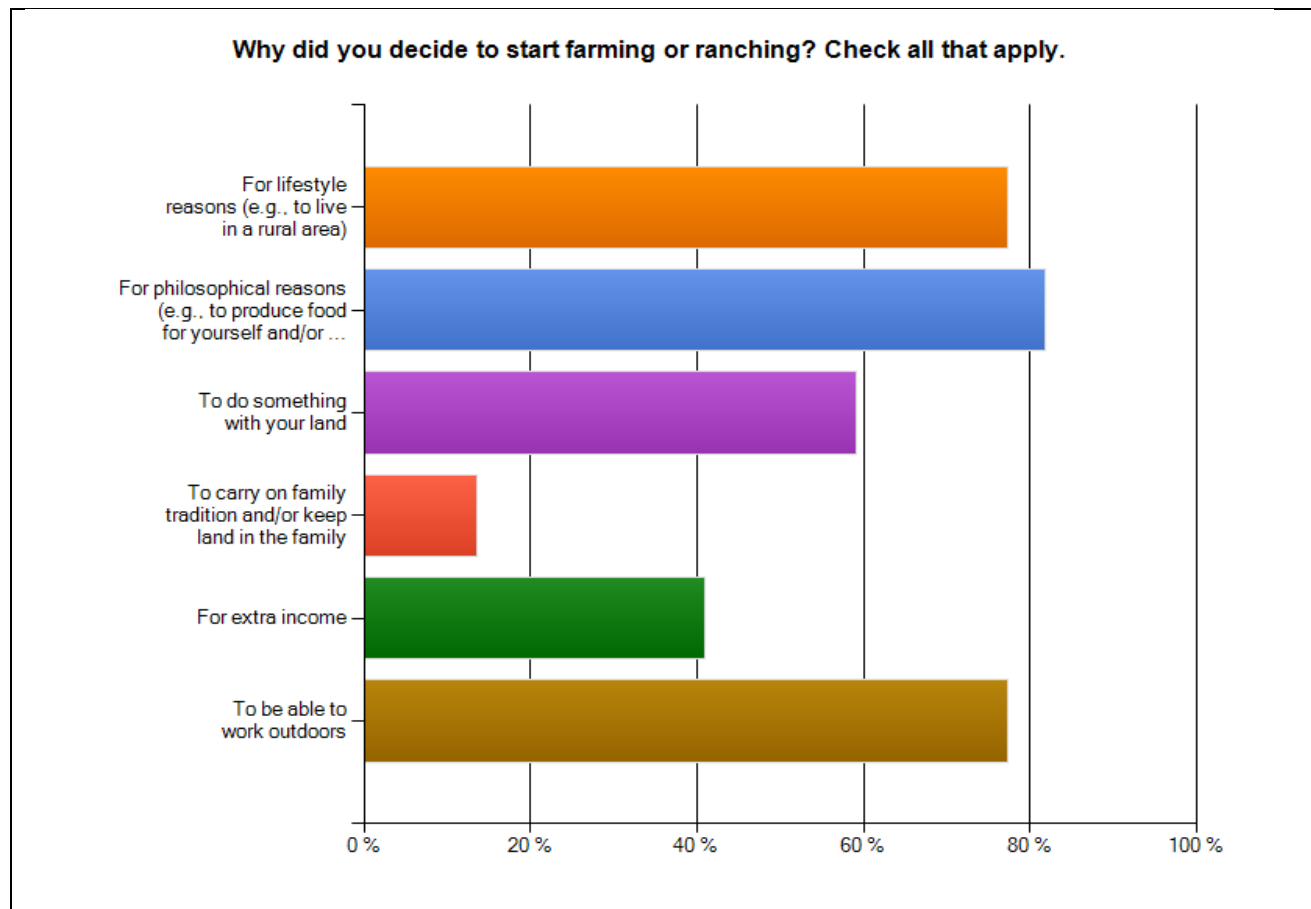

Figure 1. Most survey respondents entered agriculture for lifestyle and philosophical reasons, rather than to carry on a family tradition.

Supporting and sustaining small-scale commercial agriculture is a major goal of UCCE Placer/Nevada, thus, our Beginning Farming training programs focus on providing reality-based education to participants. Based on both the survey and post-training evaluations, it appears these goals are being met, with large percentages of respondents mentioning the reality check provided in the trainings. This is shown by evaluation comments such as:

“Quite helpful in giving me a good dose of reality!”

“Great content. Realistic planning.”

“Helped [me] get a better grasp on realities and scale needed to support our desired income and profit”  
 “It’s changed the way I look at the business end of the farm... planning to start smaller (produce fewer things) and diversify over time as the business allows.”

This emphasis on the realities of small scale farming may help aspiring producers develop more reasonable expectations about labor, stress, economics, finances, markets, and other aspects of their operations. It may also help them deal with discouragement in the start-up process, thus keeping them in farming longer. Figure 2 shows that most respondents found the various aspects of starting an agricultural enterprise to be about what they expected, although some aspects (business, finances, and regulations) were more difficult than expected. These results point to the importance of focusing on the business, economic, and marketing aspects of new operations.

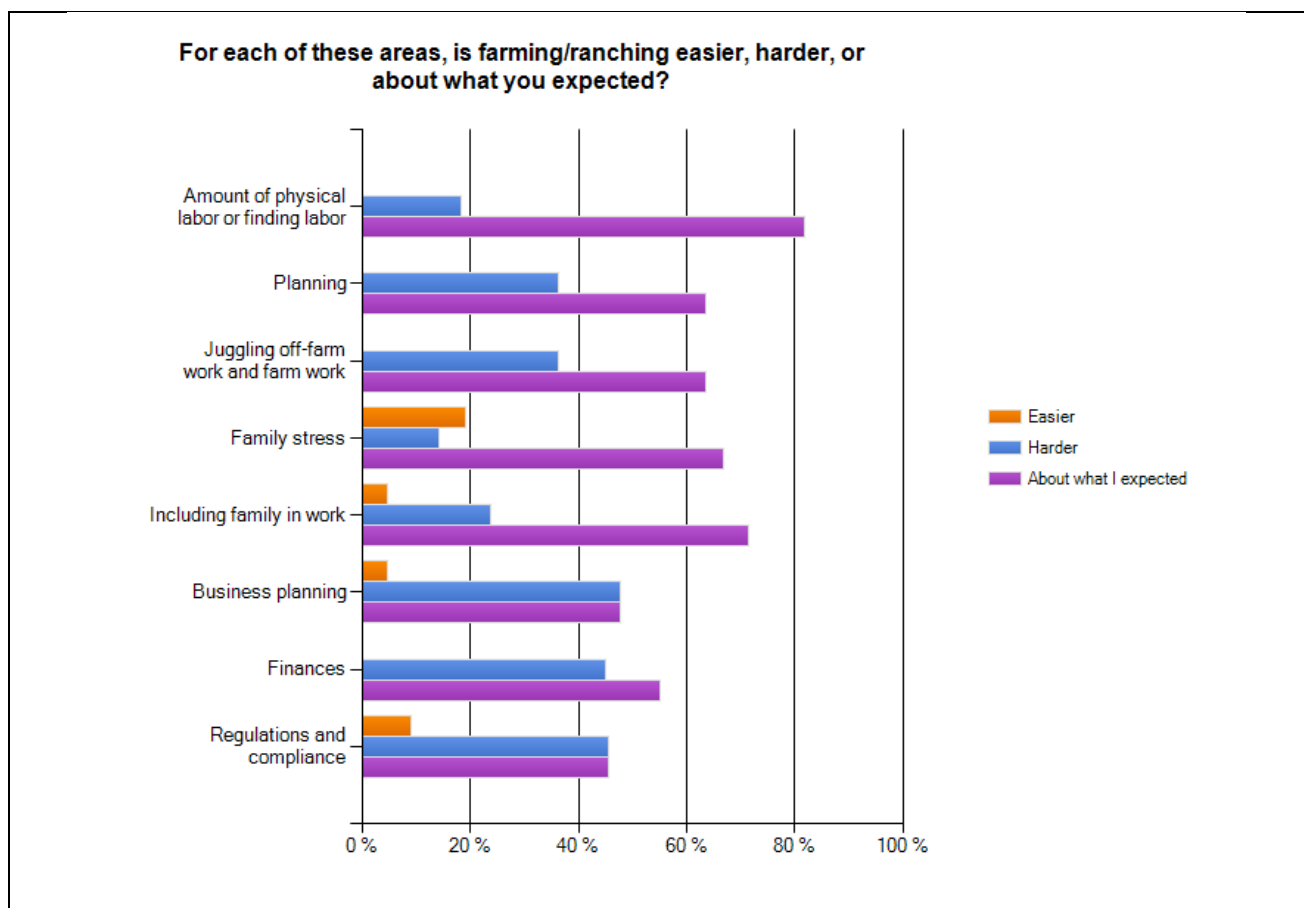

Figure 2. Comparison of the number of survey respondents for whom various aspects of farming are easier, harder, or about what they expected (expressed as percentage of respondents).

Resources from the trainings most consistently used by survey respondents included resource assessment, economic planning, and market research (Figure 3). Most respondents indicated that they have applied multiple lessons learned from the training to their new operations.

Many survey respondents specifically highlighted lessons about market-driven farming, small-farm economics, business planning, and the importance of profit to the long-term sustainability of their operations as the new or most important things they learned from the Beginning Farming training. Most respondents were able to turn information meant to provide a reality check into avenues for changing their operational plans.

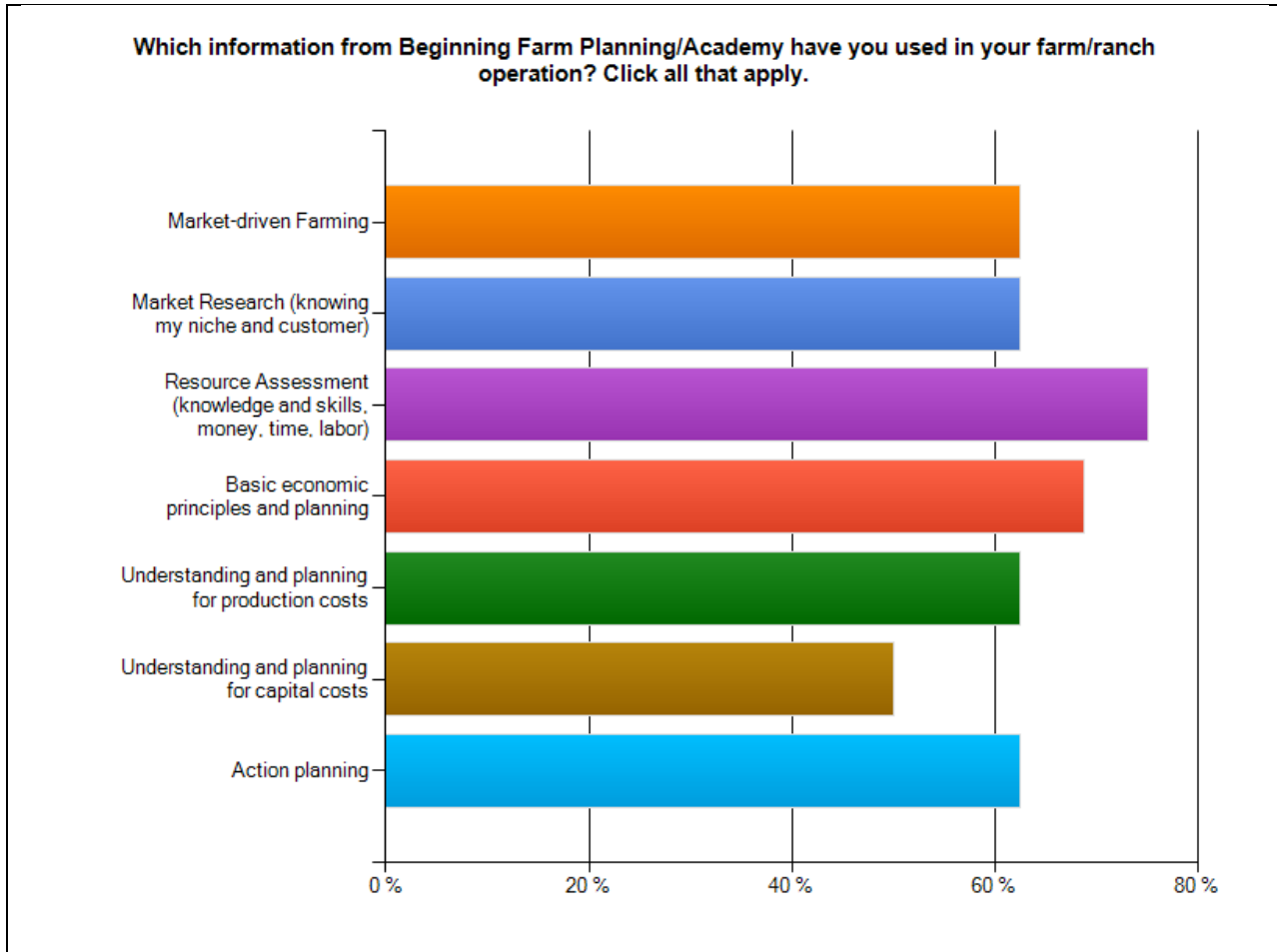

Figure 3. Information provided during Beginning Farm training that respondents have used in their operations (expressed as percentage of respondents).

Beginning Farmer training has had a number of immediate and long-term impacts for participants. As Figure 4 shows, many respondents have established or expanded their operations, while others have diversified their enterprises. Several survey respondents decided not to pursue commercial production as a result of the agricultural realities presented in Beginning Farming training. Because commercial production is challenging and risky, it is often better for an aspiring producer to decide not to invest time and finances in enterprises that may not be sustainable.

Many beginning farming participants have also made operational changes based on Beginning Farmer training. These include changes in marketing outlets and strategies, timelines for various projects and enterprises, and business strategies.

UCCE facilitates building community among local producers by hosting monthly networking breakfasts, promoting on-farm/ranch workshops, coordinating a mentoring program, and supporting a producer listserv. A majority of survey respondents improved their social connections with other producers and have shared farming techniques.

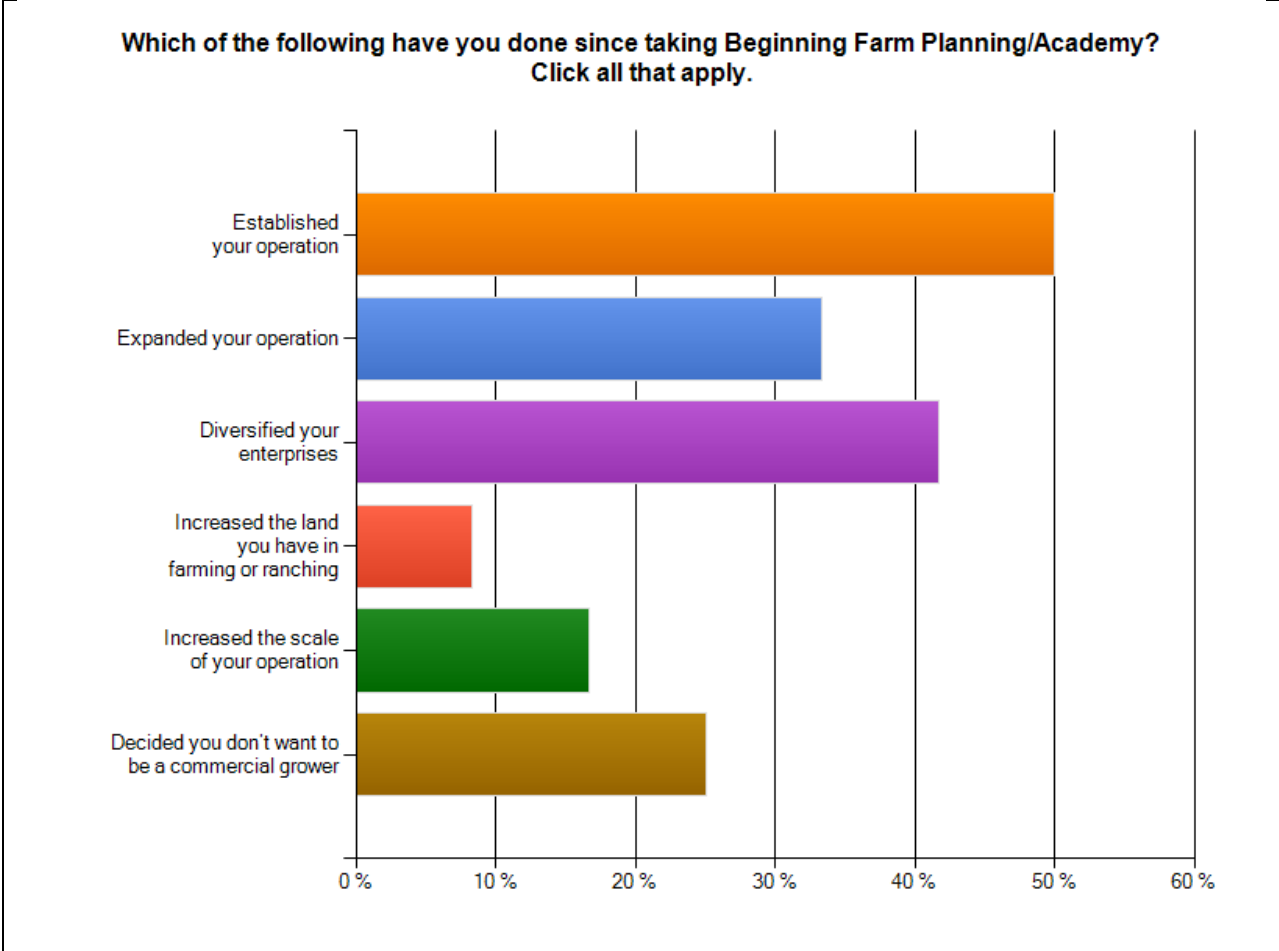

Figure 4. Activities survey respondents have engaged in since taking Beginning Farm Planning/Academy (expressed as percentage of respondents).

**Discussion**

Local context and local needs are important. Just one county over, the landscape and economics are very different, so knowing the context is important. Best practices for beginning farmer training have been suggested by various sources (Niewolny and Lillard, 2010; Ochterski and Frenay, 2010). However, being responsive to the needs and preferences of local participants, and mindful of limitations on the teaching team, particularly time resources are important to the sustainability of the training programs.

The programs discussed in this paper are local programs, intended to serve a particular region of California. However, some of the lessons learned are applicable to programs across the country. Although most training sessions have participants from outside the region, the intent is to build and strengthen a new farmer/rancher population in the foothills of Northern California. The programs are



limited by the time and resources available from UC Cooperative Extension and our producer partners. Internships can provide a useful complement to the training offered, and some farms do offer internships. UCCE has sponsored pilot internship programs in the past, but determined that management of such programs is better handled by the local community college.

Niewolny and Lillard (2010) state that successful and influential beginning farmer and rancher training programs have broad, diverse partnerships as part of their structure. Partnerships with producers, the farmers' market association, and the local community college are critical to the success and sustainability of the Placer/Nevada programs. The larger community of producers who participate in monthly farmer-to-farmer networking breakfasts, on-farm workshops, and the farmer-to-farmer listserv are also part of these partnerships. Our programs are predicated on building community among local producers and sharing information and experience within that community. Thus, producer involvement in planning, teaching, hosting workshops, and mentoring new farmers and ranchers is vital to the programs.

Another fundamental concept of UCCE Placer/Nevada training is that the experience of successful producers can provide direction and basic principles for beginning farmers and ranchers, regardless of the product or species produced. The interactive nature of the training allows for sharing a diversity of viewpoints and experiences. Presenters serve as facilitators, and the discussion is interactive, including producers and trainees. The interchange of ideas and input from experienced producers not only provides a more interesting training environment, but also emphasizes practical experience and approaches. Hands-on activities such as assessing resources, determining profit and salary goals, or preparing action plans, as well as peer to peer input on homework are also key learning tools.

Our training has, to date, focused on beginning farmers and ranchers, the majority of whom are in the first 5 years of operation. We are now beginning to focus on producers who are in the 5 to 10-year timeframe who need to reach an economically viable scale so that they are generating a profit and earning a livable salary. Typically, this means scaling up their operations. Serious challenges to increasing scale include the availability of capital, labor, and in some cases, adequate and suitable land and irrigation resources.

## Conclusion

UCCE programming in Placer and Nevada counties has focused on providing training and support to beginning farmers and ranchers because of the aging producer population and the need for a new generation of producers. UCCE is the primary avenue in Placer and Nevada counties for beginning farmer and rancher training, in collaboration with the local community college (Sierra College) and local expert farmers and ranchers.

UCCE's Extension programs provide a breadth of training and information appropriate to building the skills necessary to creating successful farming and ranching operations. The success of the training

program is due to reality based training, participation of experienced local producers as part of the training team, and an educational approach that is collaborative, participatory, and focused on helping beginning farmers and ranchers develop realistic expectations without dampening their enthusiasm.

The goal of the UCCE Beginning Farming program is to cultivate the long-term success of economically viable commercial small-scale farms and ranches. Thus, helping aspiring farmers and ranchers to understand the realities of this type of production is critical. Starting a new business of any kind is a risk and farming or ranching can be particularly risky. The training does weed out some with unrealistic expectations, and thus prevents them from making investments in operations that are unlikely to be viable. The reality of small-scale farming is that it requires persistence and determination, as well as a passion for agriculture. Without those, as well as a broad array of other skills, aspiring producers are unlikely to succeed.

*This training and work would not be possible without assistance from our partners: Allen Edwards of Edwards Family Farm, Alan Haight of Riverhill Farm, Dan Macon of Flying Mule Farm, Jim Muck of Jim's Produce, Carol Arnold of the Foothill Farmers' Market Association as well as funding from Western Sustainable Agriculture Research and Education and the USDA's Risk Management Agency.*

## References

Ahearn, Mary and Doris Newton. (2009). "Beginning Farmers and Ranchers." Washington, D.C.: U.S. Department of Agriculture, Economic Research Service. Available online at: <http://www.ers.usda.gov/Publications/EIB53/EIB53.pdf>. Accessed July 11, 2012.

Bernard, H. Russell. (2000). *Social Research Methods: Qualitative and Quantitative Approaches*. Sage Publications: Thousand Oaks, CA.

Economic Research Service. (2010). "County-Level Population Data for California." Updated April 21, 2010. Accessed August 19, 2010. <http://www.ers.usda.gov/Data/Population/PopList.asp?longname=California&st=CA&sortBy=pctCountyChange19902000&sortMsg=population+change+1990-2000&sortColumn=6&priorSortBy=pctCountyChange19902000#table>

Griffith, K. (1991). *Finding the niche: Case studies of beginning small-scale farmers with recommendations for programs for beginning farmers* Wisconsin Rural Development Center. . Mount Horeb, WI.

Ibendahl, Gregory, Steve Isaacs, and Richard Trimble. (2002). "Financial Information Base of Participants in FSA Borrower Training." *Journal of Extension* 40(5)

Niewolny, Kim L. and Patrick T. Lillard. 2010. "Expanding the boundaries of beginning farmer training and program development: A review of contemporary initiatives to cultivate a new generation of American farmers." *Journal of Agriculture, Food Systems, and Community Development* 1(1): 65-88.

Ochterski, Jim and Erica Frenay. (2010). "Best Management Practices for Beginning Farmer Support." *Journal of Extension* 48(3):

Ramsey, Fred L. and Daniel W. Schafer. (1997). *The Statistical Sleuth: A Course in Methods of Data Analysis*. Duxbury Press: Belmont, CA.

Sharp, Jeff S., Doug Jackson-Smith, and Leah Smith. (2011). "Agricultural Economic Development at the Rural-Urban Interface: Community Organization, Policy, and Agricultural Change." *Journal of Agriculture, Food Systems, and Community Development* 1(4): 189–204.

Strong, Robert, Amy Harder, and Hannah Carter. (2010). "Agricultural Extension Agents' Perceptions of Effective Teaching Strategies for Adult Learners in the Master Beef Producer Program." *Journal of Extension* 48(3).

Suvedi, Murari, Maria Knight Lapinski, and Shelly Campo. (2000). "Farmers' Perspectives of Michigan State University Extension: Trends and Lessons from 1996 to 1999." *Journal of Extension* 38(1).

Trede, Larry D. and Scott Whitaker. (1998). "Beginning Farmer Education in Iowa: Implications to Extension." *Journal of Extension* 36(5).

United States Department of Agriculture. (2009). *2007 Census of Agriculture: California State and County Data, Volume 1, Geographic Area Series, Part 5*. U.S. Department of Agriculture, National Agricultural Statistics Service. Issued February 2009. Updated December 2009.

## **Oral Presentations**

## **Session 3**

**1:30 PM - 3:00 PM**

### **Session 3 A**

**Track/Session: Marketing Opportunities/Marketing Trends Part III**

**Bundling Value for Wisconsin Farmers with Market Relationships**

*Ronald Doetech, Solutions in the Land, LLC, Poplar Grove, IL*

### **Bundling Value for Wisconsin Farmers with Market Relationships**

**Ronald Doetech**

**Solutions in the Land, LLC, Poplar Grove, IL**

#### **Introduction**

The combination of growing demand for local organic food, rising agriculture input costs, and an increasingly vulnerable and variable environment create fertile ground for a fundamental shift in agricultural practices that can benefit local economies, the environment, and public health. The current focus on monoculture commodity crops results in damaged soils and contaminated water, and farms that are vulnerable to failure from pests, climactic events, or market fluctuations. There are numerous on-going efforts designed to shift farming activities in a more positive direction, but they tend to have a narrow focus and ignore the potential benefit of a whole-systems approach. New relationships and long-term partnerships must be forged in order to design and execute whole farm plans, create new value-added products, and bring these goods and services to the correct market. With these partnerships in place, there is enormous potential to establish farming practices that can increase revenue for farmers, create local jobs, improve local and regional ecology and hydrology, and strengthen rural communities. Demonstration farms participating in this project showcase highly integrated and diversified farming operations that create value-added products from species that simultaneously contribute to ecosystem health and create new revenue streams.

## **Background**

Our team has, and is currently, working with several initiatives striving to fill the gaps in local food systems while assisting farmers, new and old, to become a part of an agriculture that provides multiple local benefits while restoring land. From the east coast to the west, there are both common and uncommon threads to these initiatives and opportunities. Today, the challenge to long-term, whole farm planning is the absence of consolidated information that connects the multiple cross-sector opportunities. For instance, granting development rights of agriculture land can be an income tax advantage for the owner, but how does that impact a tenant who is participating in the Grassland Reserve Program (GRP) while tactically restoring the land ahead of orchard development? Will fresh market vegetable production on program farmland disqualify participation in cost-sharing reimbursement programs? If a cover crop is planted in October for nitrogen production, can the spring planted crop be insured as the first crop? How can lease-hold improvements benefit a departing tenant? For the past four years, our team has been populating a decision tool with real-time land use options that can answer these and hundreds of other scenarios that land owners and managers must consider in making and marketing good choices.

We base revenue and expense projection in the development of a whole farm business plan, with an appreciation that every acre, every field, and every farm unit is distinctly different and site-specific. Hence, every whole system farm plan solution must be tailored to take advantage of the multiple opportunities afforded by the combination of soils, topography, surface and ground water resources, geology, climate, native flora and fauna, and other historical ecological and cultural factors unique to each place. Because we consider water to be the key to sustained agricultural viability, we approach farm planning within the context of its watershed including its relationship with both up and downstream land and water resources. We realize that to become economically viable, the farm enterprise requires 20-30 income streams that are not interdependent and have different cycle characteristics. This often involves marketing the story, the place, and the relationship with its own unique branding. Docking with downstream processors can mitigate risk and provide resilience not enjoyed by most farms. Adding value to products at the farm can be integral to a successful strategy when and where investment and core competency match-up well, but is not the only way to bring extra value back to the farm gate. In addition, our goal is to not only restore economic vitality to the farm producer, but to introduce whole systems strategies and products that will create new industries, jobs, and economies for local rural communities. Most rural communities have struggled both economically and socially for decades under the current agricultural paradigm which results in the import of inputs, and the export of outputs, often at the expense

of the economic and ecological health and well-being of local farm families, rural communities, and the land and water resources upon which their livelihoods depend.

Integral to any whole-systems design is minimizing purchased inputs while maximizing marketable outputs without depleting the system. This implicitly requires a creative approach when dealing with what is conventionally considered “waste.” In this regard, a number of Midwestern farms have identified opportunities to capitalize on waste or underutilized resources by converting them into energy. Using technology like methane digesters, biomass boilers, solar panels, and wind turbines, farms are already generating large portions of their electricity. This allows farms to reduce costs and waste, and remain insulated against variations in electricity costs and availability.

After the initial scan and evaluation, we make a deep dive with all existing and potential stakeholders knowing that pieces of the puzzle are held by many. This participation of stakeholders is not only critical to determine successful strategies, but also for their ownership of the plan as it develops. New relationship possibilities need thorough vetting as successful long-term relationships do not arise from chaotic reactions or quick, short-term financial gain. For example, on a whole farm plan that we are working on in Southwest Michigan, the Pokagon Band has a significant population and interest in reinvigorating their community. The Southwest Michigan Land Trust has multiple land holdings that are in need of viable enterprises. Markets want locally produced food. The opportunity is recombining relationship in a new way that contributes to long-term resilience for all stakeholders. The water, land, air quality and wildlife resources must be preserved for posterity while finding the balance of human deposits to, and withdrawals from, these resources.

### **Case Study- Death’s Door Spirits and Washington Island, WI**

Washington Island is located about seven miles off the tip of Door County peninsula. Geologists say that millions of years ago the island was part of the mainland. It is one of a group of 20 islands that separate Wisconsin and upper Michigan. Many of these islands have interesting histories, but are now isolated. Washington Island alone has an interesting past and a promising future.

The water separating the Island from Wisconsin mainland has been given the ominous name of Deaths Door, or as the French call it, Port des Morts. In spite of the name, these waters are perfectly safe for modern navigation. Early settlers often crossed in row boats and in the summer of 1953, a Milwaukee man swam across the Door. The name dates back to the time when a war party of 300 Indians tried to cross in canoes on a stormy night. They all lost their lives, and thus began the legend that the waters were infested with an evil spirit.

The first inhabitants of the Island were Indians. Records show that Indians lived here as late as 1860. The warlike Winnebagos and later the Potawatomis were among the first. When the Iroquois Indians of New York secured guns from Dutch traders in 1617, they waged successful war against the neighboring tribes. History tells that those who escaped fled to Washington Island.

In 1679, LaSalle’s famous Griffon left the harbor of the Island loaded with furs; it was never heard of again and it seems probable that it was lost in the Door.

The Island did not receive its name until 1816. The Federal Government sent three ships of sailors to Green Bay to prevent the English from inciting the Indians against the American colonists. One of these vessels, the “Washington”, became separated from the others on the second night out and

put into the nearest harbor. It waited there several days for the other boats. During those days, the men rambled over the Island, and in honor of their vessel gave the name “Washington” to both the island and the harbor that had sheltered them.

Before the Civil War, there was a negro settlement of nine families at what is now called West Harbor. It is thought that these negroes were runaway slaves who found refuge here.

In the 1860s there was an Irish village on the West side of Washington Harbor. On the East Side of the same harbor are still the remains of what was once called Dutch Village.

The town of Washington was organized June 20, 1850. Amos Sanders was the first Town Chairman and H. D. Minor was the first Town Clerk.

The first Icelanders who came to Washington Island in 1870 were fishermen. They wrote to their friends in Iceland and encouraged them to come too. The names of those first settlers are the same as those of their descendants who still inhabit the Island: Gisslasson, Gudmundsen, Gunnlaugsson, Einerson, and Johnson.

Fishing was the leading industry of these early settlers. At Jackson Harbor, a fleet of boats would leave at day break and return in the early afternoon with their catch of whitefish, herring, or chubs. The trout that also attracted earliest fishermen are now being sought by sports fishermen.

Agriculture also was an important industry. There were many herds of cattle and the cheese factory was known for its excellent Island cheese. Potatoes were an important crop and the potatoe harvest in September was one of the busiest times of the year. There are now only a few part-time cattle farms left.

Many of the Island men were Great Lakes sailors. Almost all the grown men could reminisce about their year or more as a Great Lakes sailor. Some have continued their work and are now Captains and Chief Engineers on ore freighters that travel the Lakes.

Because of its cool summers, beautiful scenery and good fishing, the Island has always attracted tourists which is now the main industry. Many attractive cottages have been built along the beaches where summer friends have their summer homes. There are attractive hotels and cottages for those who can spend only a short time here.

Getting to the Island is an interesting experience even for those who have crossed the Door hundreds of times. There is a fleet of five ferries that cross from Detroit Harbor Dock on Washington Island to Northport Dock at the end of Highway 42 from one trip a day in the winter to twenty five trips at the height of the summertime tourist season. The 35 minute boat ride is usually calm and pleasant, but if the wind is strong, it can be as rough as an ocean voyage and occasionally the passengers become seasick. Since the distance is short, this never lasts long. *Washington Island Historical Archive Committee (1989)*

In 2005, Brian Ellison with a degree in Landscape Architecture and Sustainable Design toiled in the back room of the prominent Wisconsin land planning firm Vandewalle and Associates when founder, Brian

Vandewalle, persuaded Ellison to help him restore an old hotel and breathe new life into the 22-square-mile island in Lake Michigan – ironically located northeast of Door County across from what is known as Death’s Door Passage, known as Washington Island. But because eco-tourism only lasts about five months of the year, the duo needed something else to tide the 700 permanent residents over the rest of the year. Of course, they looked to the land. They contacted Ron Doetch, Solutions in the Land, managing partner, to seek out valuable differentiated wheat that could be produced on the island to be used for alcohol and baking. “The first year we had 5 acres of hard, red wheat,” Ellison said. “By the second year, it was up to 20 acres.”

But what to do with the wheat? Ellison took some samples to Capitol Brewing in Madison, Wis., only to learn they used barley. But then something strange happened: They contacted him. They were thinking about launching a wheat beer and liked the Washington Island connection and cachet. The two Brians had the head baker in the Washington Island hotel bake bread with the island wheat for the guest of the hotels, but neither the beer nor the bread used a significant amount of the wheat to bring economic value to the long-time farmers of the island. Ellison sought to expand the opportunity by converting the wheat to mash, contract Great Lakes Distillery in Milwaukee and Yahara Bay Distillers in Madison to make Death’s Door Spirits – gin, vodka and whiskey.

Between the years 2006 and 2008, relationships were tested. The farmers sensing prosperity from identity-preserved wheat, produced without worry of the market. Ellison’s attention had to be focused on a new start-up business with a new model for craft distilling and marketing. Potentially, a rivalry was setting up between the two spirits makers to compete for the island wheat despite the reality that neither had enough market for the existing production and the farmers were not making any money. Brian Ellison stepped-up and recognized that everyone needed to share in the vision, the decisions and the outcomes.

Death’s Door Spirits gave the farmers a contract to insure their year-round income. Ron Doetch was re-enlisted to work with the whole farm plans for the island agriculture including raising inputs such as nitrogen with additional crops like red clover. An agreement was made with Capitol Brewing to work as a single purchasing entity for the island wheat to dock the annual needs for wheat with the production and the farmers.

The Island Wheat Beer had become a flagship beer for Capitol Brewery and Death’s Door Spirits sales jumped from a few cases in 2006 to 8,000 cases in 2011, climbing to 60,000 in 2012. The farmers now have a five-year contract for production of high-value wheat with plans for Death’s Door to build a storage bin on the island to accumulate a buffer stock of wheat. There is now shared decision-making on production quantity and value. Death’s Door Spirits new state-of-the-arts still in Middleton can produce 300,000 cases per year.

New contracts are being signed for the production of Juniper berries, coriander seed, fennel seed, barley and other crops using the same model contract, sharing in decisions and outcomes. This includes production research identifying ways to reduce production inputs and improve the products while becoming a better environmental steward. Plans include adding a grain cleaning facility, still and whiskey storage on the island. This is creating more jobs, new businesses and enhancing the tourism trade of the island hence supporting a more vibrant economy for the year-round residents of the island. Plans also include ideas to deepen the relationship between the activities on the island with the processing in Middleton and the consumers who purchase the regionally branded spirits- internationally.

## **Epilogue**

The market place is very dynamic with the emerging consumer awareness of food systems, food policy, food safety and the relationship to human and environmental well-being. A broad reach is necessary to keep abreast of these market opportunities and relationships as well as new crops and cropping techniques. Sharing equity throughout the value chain is dynamic and difficult. Social barriers must be recognized, understood and overcome. More stakeholders must be at the decision table and ownership of the outcomes must be shared as equally as the monetary values. To respond to the changes demanded of agriculture today, we do not have time to repeat the same mistakes. We must synthesize the knowledge gained from those who have gone before and meld those shortcomings into success.

### **The New FaR<sub>x</sub>macy: Increase Profitability by Teaching Customers to Eat their Vitamins**

*Theresa J. Nartea, Virginia State University Cooperative Extension, Petersburg, VA*

### **The New FaR<sub>x</sub>macy: Increase Profitability by Teaching Customers to Eat their Vitamins**

**Theresa J. Nartea**

**Virginia State University Cooperative Extension, Petersburg, VA**

Small farmers engaged in direct marketing can gain a competitive edge by teaching customers to “Eat their vitamins” with local farm produce and products. Promoting locally grown foods as a functional food category or as a Superfood is a promising market niche for small farmers. The purpose of this presentation is to teach small farmers effective marketing strategies to promote and sell more farm products through nutrition education paired with consumer understanding of the superfoods or functional foods branding concept.

Nationally, 52 percent of adults and 34 percent of youth (12-17) are dieting to prevent obesity. One out of every three children is currently overweight (Sloane, 2010). Annually, the United States could prevent \$71 billion dollars in losses from medical costs, lost productivity, disability, and premature deaths if healthy food choices were promoted to consumers (Frazao, 1999).

Functional foods, also branded as “superfoods” are garnering increased consumer interest (Business Insights Marketing Group, 2011). A superfood is defined as a food that is considered to be very good for your health and that may even help some medical conditions (Macmillan Publishers Limited, 2011). Functional foods sales reached \$37.4 Billion in 2009 in the United States with 6 out of 10 consumers buying functional foods in 2009 (Sloane, 2010).

Over half of the adults in the United States believe in the disease-preventative properties of natural foods such as fruits, vegetables and cereal grains (Urala and Spinks 2011). Nearly 75 percent of U.S. consumers purchase food for health maintenance (Childs and Poryzees, 1998). Integrated Extension education is needed to teach small farmers how to effectively promote their products as superfoods.



Participants will learn about demystifying media promotion of superfoods and learn how to integrate the sales strategies of: (a) eating by colors, (b) effective product signage techniques, and (c) Superfoods value menu within this educational presentation.

## References

Business Insights Marketing Group. (2011). Future ingredient trends in food and drinks. “Retrieved from <http://www.docstoc.com/docs/33444601/BUSINESS-INSIGHTS-Future-Ingredient-Trends-in-Food-and>; MediaPost Publications.

Childs, N. M., & Poryzees, G. H. (1998). “Foods that help prevent disease: consumer attitudes and public policy implications.” *British Food Journal*, 100 (9). 419-426.

Frazao, E. (1999). “America’s eating habits: Changes and consequences.” Retrieved from <http://www.ers.usda.gov/Publications/AIB750/>

Macmillan Publishers Limited. (2011). “Superfood definition”. Retrieved from <http://www.macmillandictionary.com/dictionary/american/superfood>

Urala, N., Schultz, H., & Spinks, J. (2011). “Consumer perceptions of functional foods in the United States”. *Journal of Food Products Marketing*, 17: 407-419.

## Session 3 B

**Track/Session: Outreach to Underserved Communities/Immigrant Farmers**

### **Helping Small, Latino, and Hmong Growers to Profit from New Values Based Marketing Channels**

*Gail Feenstra and David Visher, University of California Sustainable Agriculture Research and Education Program (SAREP), Agricultural Sustainability Institute, University of California Davis-Davis, CA*

### **Helping Small, Latino, and Hmong Growers to Profit from New Values Based Marketing Channels**

**Gail Feenstra and David Visher**

**University of California Sustainable Agriculture Research and Education Program (SAREP)**

**Agricultural Sustainability Institute**  
**University of California Davis-Davis, CA**

A new market is emerging in the produce industry that is driven by consumer demand for products with values attached of "local," "sustainable," "family farmed," "ethnic," and "identity preserved" The distribution industry, non-profits, and farmer organizations are mobilizing to meet this demand. They need appropriately prepared farmers to make these "values- based supply chains" (VBSC) succeed. Small, Hmong, Mien, and Latino farmers are a rapidly growing segment of California's agricultural landscape. However, many do not understand how to create an effective marketing plan with authentic branding messages. They face barriers when communicating with buyers.

We have been studying these VBSC emerging markets and business models for food hubs at the University of California Sustainable Agriculture Research and Education Program (UC SAREP), over the last several years. (see the research summaries at [www.sarep.ucdavis.edu/sfs/VBSC](http://www.sarep.ucdavis.edu/sfs/VBSC) ) .

A grant from the California Specialty Crop Block Grant program has made it possible to create an outreach and education program targeting this clientele.

Workshops are weak tools with this audience. We focused instead on experiential learning by introducing the growers to buyers during three tours of produce marketing districts in San Francisco, Los Angeles, and Sacramento. The tours were preceded by short workshops that were taught by native speakers or with translators. Growers were assisted in creating an edited profile to give to buyers that told their unique marketing story and provided basic information about what they grow, their farm, their story, and how to make contact.

The workshops targeted 80-100 farmers who, as early adopters, influence other producers in their communities to profit from high value marketing channels. Evaluations completed during the workshops, and several months after the tours helped us assess the number of marketing connections and other impacts that occurred as a result of the project.

Our cooperators are farm advisors who maintain ongoing programs for these growers. They provide additional support through planned in-depth business mentoring programs.

**Outreach and Assistance to Hmong Farmers in Southwest Missouri**

*Sanjun Gu, Nahshon Bishop, and Sarah Becker, Lincoln University Cooperative Extension, Jefferson City, MO*

**Outreach and Assistance to Hmong Farmers in Southwest Missouri**

**Sanjun Gu, Nahshon Bishop, and Sarah Becker**  
**Lincoln University Cooperative Extension, Jefferson City, MO**

## **Background**

In southwest Missouri, there has been an influx of Hmong immigrants throughout recent years. These Hmong individuals have worked tirelessly to weave themselves into Missouri's agricultural framework. However, they often face difficulties because of the language barrier and unfamiliarity of the American agricultural practices. Hmong farmers are typically illiterate, possessing the equivalent of a formal middle school education. The Hmong language is a spoken language so handouts and fact sheets in Hmong have made limited impact. This language barrier has become a major obstacle, especially when dealing with large groups of Hmong speaking individuals. Often, high school Hmong children serve as translators.

Since 2010, the Lincoln University Cooperative Extension (LUCE) 2501 Program has worked with this group and provided assistance in sustainable crop production and participation in USDA programs. The 2501 program in southwest Missouri is currently in contact with more than 28 Hmong farmers on a regular basis. Our program has been paramount in the establishment and retention of these individuals and has been successful in connecting Hmong farmers to cost-share initiatives and research-based information. In turn, Hmong farmers in southwest Missouri have enjoyed greater economic security and farm ownership.

## **Methodology**

One of the most difficult challenges facing the 2501 program continues to be education. Educating Hmong farmers takes place through three primary avenues: on-site visits to individual farms, workshops and monthly informational booth at farmers markets.

The 2501 program educators conducted monthly or bimonthly farm visits based on the needs and seasons. This helped identify and solve emerging and on-going problems on each farm. When common problems arose or new USDA programs were released, workshops would be organized to address the topics/problems to larger Hmong groups at a centralized location, which proved to be more efficient in using resources.

To measure impacts of these workshops, pre- and post- workshop evaluation forms were distributed to individuals at the beginning and end of each workshop, respectively, and to be completed by participants. Follow-up farm visits allowed program assistants to note any changes made on the farm as a direct result of the workshops.

Informational booths held at a variety of venues have been a successful endeavor of the 2501 program in southwest Missouri. A booth held the first Friday of every month at the Webb City Farmers' Market in Webb City, MO, was the primary outreach to Hmong farmers in southwest Missouri. Most Hmong farmers the 2501 program works with are vendors of this farmers market.

## **Result**

### ***Farm Visits***

The visits have been well accepted by Hmong farmers. They allowed us to see a more detailed picture of individual farmers' needs, and then to dispense applicable information for the farmer and to introduce more sustainable methods of production on an individual basis. Program educators were able to visit at least once per month to each Hmong farm. Each farm/farmer has turned out to be different. There is apparently no specific formula that can be applied to all Hmong farmers.

### ***Workshops***

During farm visits and through received phone calls from these farmers, the 2501 program educators have identified many "shared problems" and have conducted the following workshops:

- High Tunnel Installation workshop
- High Tunnel Production and Season Extension workshop
- Soil Fertility- the Basics
- Disease and Pest Identification workshop
- IPM and Sustainable Pesticide Usage workshop
- Postharvest Handling workshop
- Native Plant and Pollinators workshop
- End of Season Farmers' Forum
- How to Use Your New *Midwest Vegetable Production Guide* workshop
- GAP Certification workshop
- SARE-Farmers and Ranchers Grant Writing workshop
- Grow Your Farm course
- USDA Limited Resource/Socially Disadvantaged Farmers and Ranchers Outreach workshop
- In addition to farm visits and workshops, several farm tours were organized to allow Hmong farmers to learn from each other and to ask educator questions based on what they were able to see.

Collectively, more than 230 individuals have attended the total of 26 workshops. These workshops were typically small in size (6-15 farmers) and short (2-4 hours), which allowed hands-on, better delivery on information and comprehensive Q&As. Most of the time, Hmong kids with some production background served as translators. Pre- and post-workshop surveys have shown the gain in knowledge of Hmong Farmers after attending the workshops.

Workshops introducing USDA programs have been fruitful. Two Hmong farmers have received NRCS High Tunnel EQIP and have erected high tunnels on their farm, which greatly boosted vegetable production. Six Hmong farmers applied for emergency drought relief from the Department of Reservation/NRCS Soil and Water Conservation District, two of them successfully received funding. One Hmong farmer turned in a proposal for the SARE Farmers and Ranchers' Grant.

### ***Informational booth***

Booths held at a variety of venues have been a successful endeavor of the 2501 program in southwest Missouri. A booth held the first Friday of every month at the Webb City Farmers' Market was the primary outreach to Hmong farmers in southwest Missouri during the establishment of the 2501 program. Our time at the booth permitted us to take note of the quality and quantity of produce that Hmong farmers produced and sold to the general public. This also allowed us to assist the farmer on the spot if any problems are apparent as well as set up farm visits if needed.

### **Success Story**

One Hmong farmer has come to rely on the 2501 Program in southwest Missouri. Our first contact was on June 6, 2010. Initially, he was farming three acres of assorted fruits and vegetable crops and had one 20' X 40' greenhouse, which he used to start most of his vegetable transplants. His immediate concerns were supplemental irrigation, equipment, and storage facilities. This Hmong farmer now has a working well for irrigation. He owns a raised bed/plastic mulch laying implement that allows him to grow on plastic and reap a multitude of labor-saving benefits as well as a "Cool-Box" storage room, so he is able to store his produce safely while retaining its nutritional value. He has also recently qualified for the NRCS-EQIP High Tunnel Initiative that helps fund materials for a high tunnel that will be put together in the fall (2012) under the 2501 Program supervision. He has agreed to open his farm for the high tunnel construction, allowing us to sponsor a high tunnel workshop specifically directed at Hmong growers in the region. He has seen an average of \$2,000 increase in sales in 2011-12 year due in part to the 2501 Program assistance. This Hmong farmer's future plans involve expanding into small fruit production and increasing acres dedicated to the production of traditional horticultural crops.

Another Hmong family in southwest Missouri has recently received emergency assistance for the implementation of a well on the farm to irrigate traditional horticulture crops. Not having a reliable supplemental water source has had adverse effects on the family, who until now have been trying to water their two-acre field of crops with a 3/8-inch garden hose from their house. As a direct result of this well, the family plans to expand the growing area by 50 percent for the 2013 growing season.

### **Future Plans**

Connecting Hmong farmers to sustainable agriculture and cost-share incentives and programs through USDA continue to be our primary focus. Surveys will be issued this fall (2012) to ask Hmong farmers to outline the impact that the program has had on their bottom line. The 2501 program also plans to convince these Hmong farmers to attend the 2<sup>nd</sup> Missouri Minority and Limited Resource Farmers' Conference in 2013.

## **Session 3 C**

**Track/Session: Program Planning and Implementation/  
New and Beginning Farmers Part I**

**Rutgers Cost Accounting Program Now Tracks Cash Flows**

*Robin G. Brumfield and Christina Gouliamberis, Rutgers, The State University of New Jersey, New Brunswick, NJ*

**Rutgers Cost Accounting Program Now Tracks Cash Flows**

**Robin G. Brumfield and Christina Gouliamberis**

**Rutgers, The State University of New Jersey, New Brunswick, NJ**

**Introduction**

How do producers make money with shrinking margins, rising costs, and demanding customers? The first step is to determine their costs. But most Northeastern producers grow a variety of different crops, and with so many crops, how do they determine the cost of production for each one. How do they know which ones are making money, and which ones are losers? A simple cost accounting program developed in Microsoft Excel and distributed by Rutgers University lets producers determine the costs and returns of each crop that they produce. The newest version of this user-friendly cost accounting software program allows producers to track their cash flows. While the initial program was developed for greenhouses so they can track their costs of production, the latest version also calculates costs of crops produced outdoors as well as greenhouse crops. The program generates information showing total costs and returns for the farm, per crop, and per unit. It enables a producer to easily determine the profitability of each crop. From this information, they can determine which crops are their winners and losers. This software also can help producers make decisions on pricing, identifying and reducing unprofitable crops and increasing sales of profitable crops.

**Rutgers Cost Accounting Program**

The Rutgers Cost Accounting Program starts with information producers have on hand: an income statement and balance sheet. From information entered from the income statement, the program calculates the percentages of each overhead cost. Using information from the income statement and balance sheet, the program calculates 17 key financial ratios for cost analysis. In addition to analyzing their actual costs, producers can use the program as a planning tool to analyze the impact of increased energy costs and other costs. Producers can consider changes in product prices, marketing margins, and other changes after successfully using this analysis.

For example, Table 1 shows figures for a typical Northeastern greenhouse producer with a greenhouse that is 138,759 sq ft in size, annual sales of \$2.2 million, and net returns of \$211,152, or 9.5 percent. Annual costs and returns expressed in dollars and as a percentage of sales are listed in the “Base costs” columns. The program allows producers to make changes in the data to see how the changes will affect net returns and financial ratios. In the middle two columns in Table 1, fuel costs are tripled, but other costs and product prices are the same. This increase in energy costs causes net returns or profits to go from \$211,455 or 9.5 percent or sales to a loss of \$37,585 or 1.7 percent. In the two columns on the right in Table 1, we have tripled the energy costs compared to the base, but also increased the sales prices of all of the crops by 5 percent. After this change, the net returns were again positive but not as large as before the energy costs were increased. After this change, net returns were \$73,393, or 3.1 percent.

The program gives producers results on a per crop, per unit, and per square foot basis. More explanation of these features is discussed in *New and Emerging Technologies for Enhancing Small Farm Profitability*.

### The New Rutgers Cost Accounting Program

The newest feature of the Rutgers Cost Accounting Program is a cash flow analysis. Cash flow plans are an important tool for evaluating the liquidity of a farm business, the annual operating loan needs, and the ability of the business to repay loans. Lenders usually want to evaluate the projected cash flow when making loan decisions. Owners will want to have a line of credit or operating loan to cover short falls. A cash flow projection should also indicate potential financial problems and alert the manager and lenders to possible changes that might be made. The program entails combining what are on the balance sheet and the income statement and creating “Cash on Hand,” “Cash Receipts,” and “Cash Paid Out” sections. This way the farmers can start with this information and show how changes in balance sheet accounts and income statement affect cash being used and the flow of cash in and out of the business on a monthly basis. The cash flow also breaks down the analysis to operating, investing, and financing activities (Table 2). The program takes the beginning cash balance and then the producer enters monthly income and expenses. Producers must buy inputs and produce the crops before they sell them and receive income. Thus, we can see from the cash flow in Table 2, this example has a negative cash position until May, and then the position is positive for the rest of the year. While this business is profitable, they will need to borrow operating capital of nearly \$700,000 for the first five months of the year. Completing the cash flow analysis can help producers plan for these borrowing needs.

Table 1. Income statement data from a survey of Northeast Greenhouse Growers in 2003 entered into the Rutgers Greenhouse Cost Accounting program.

	<i>Base Costs and Returns</i>		<i>Tripled Energy Costs</i>		<i>Tripled Energy Costs/ Prices Increased 5%</i>	
	\$	% of Sales	\$	% of Sales	\$	% of Sales
Sales	\$2,219,560	100.0%	\$2,219,560	100.0%	\$2,330,538	100.0%

Directs costs						
Seeds, cuttings, or plants	\$490,540	22.1%	\$490,540	22.1%	\$490,540	21.0%
Pots or containers	\$141,180	6.4%	\$141,180	6.4%	\$141,180	6.1%
Marketing containers	\$6,915	0.3%	\$6,915	0.3%	\$6,915	0.3%
Growing medium	\$37,341	1.7%	\$37,341	1.7%	\$37,341	1.6%
Fertilizer and chemicals	\$40,753	1.8%	\$40,753	1.8%	\$40,753	1.7%
Tags	\$60,160	2.7%	\$60,160	2.7%	\$60,160	2.6%
Sales Commissions	\$2,875	0.1%	\$2,875	0.1%	\$2,875	0.1%
Other	\$998	0.0%	\$998	0.0%	\$998	0.0%
Overhead salaries (including benefits)	\$42,562	1.9%	\$42,562	1.9%	\$42,562	1.8%
General wages (including benefits)	\$728,496	32.8%	\$728,496	32.8%	\$728,496	31.3%
Utilities						
Heating fuel/Machinery Fuel	\$77,566	3.5%	\$232,698	10.5%	\$232,698	10.0%
Electricity	\$40,352	1.8%	\$40,352	1.8%	\$40,352	1.7%
Telephone	\$5,894	0.3%	\$5,894	0.3%	\$5,894	0.3%
Water	\$464	0.0%	\$464	0.0%	\$464	0.0%
Overhead						
Depreciation	\$92,642	4.2%	\$92,642	4.2%	\$92,642	4.0%
Interest	\$8,080	0.4%	\$8,080	0.4%	\$8,080	0.3%
Repairs	\$43,829	2.0%	\$43,829	2.0%	\$43,829	1.9%
Taxes	\$26,131	1.2%	\$26,131	1.2%	\$26,131	1.1%
Insurance	\$37,546	1.7%	\$37,546	1.7%	\$37,546	1.6%
Advertising	\$11,277	0.5%	\$11,277	0.5%	\$11,277	0.5%
Travel and entertainment	\$7,431	0.3%	\$7,431	0.3%	\$7,431	0.3%
Office expense	\$9,589	0.4%	\$9,589	0.4%	\$9,589	0.4%
Professional fees	\$19,444	0.9%	\$19,444	0.9%	\$19,444	0.8%
Truck expense and equipment rental	\$46,954	2.1%	\$140,862	6.3%	\$140,862	6.0%



Land rental	\$2,112	0.1%	\$2,112	0.1%	\$2,112	0.1%
Miscellaneous	\$26,974	1.2%	\$26,974	1.2%	\$26,974	1.2%
Total expenses	\$2,008,105	90.5%	\$2,257,145	101.7%	\$2,257,146	96.9%
Net Returns	\$211,455	9.5%	(\$37,585)	-1.7%	\$73,393	3.1%
Greenhouse area (ft <sup>2</sup> )	138,759		138,759		138,759	
Greenhouse space used for production (%)		75		75		75
Weeks in operation (52 if a full year)	40		40		40	

Table 2. Cash flow categories in the Rutgers Greenhouse Cost Accounting program with information for the previous year taken from the income statement.

From Income Statement Previous Year	Greenhouse Cash Flow (12 months)	Cash Flow Begins: _____												Total Item
		Jan	Feb	Mar	Apr	May	Jun	Jul	Aug	Sep	Oct	Nov	Dec	
\$128,362	Cash on Hand (beg of month)	\$128,362	-\$449,555	-\$567,671	-\$677,788	-\$269,198	\$282,899	\$477,960	\$505,021	\$522,082	\$263,363	\$260,424	\$224,558	
	<b>CASH RECEIPTS</b>													
\$2,120,243	Gross Income	\$6,000	\$2,000	\$10,000	\$522,243	\$750,000	\$300,000	\$50,000	\$40,000	\$20,000	\$20,000		\$400,000	\$2,120,243
	Collections from Accounts Receivable accounts													\$0
	Other Income													\$0
	Other Income													\$0
\$2,120,243	<b>TOTAL CASH RECEIPTS</b>	\$6,000	\$2,000	\$10,000	\$522,243	\$750,000	\$300,000	\$50,000	\$40,000	\$20,000	\$20,000	\$0	\$400,000	\$2,120,243
\$128,362	Total Cash Available (before cash out)	\$134,362	-\$447,555	-\$557,671	-\$155,545	\$480,802	\$582,899	\$527,960	\$545,021	\$542,082	\$263,363	\$260,424	\$624,558	
	<b>CASH PAID OUT</b>													
	<b>Direct Costs:</b>													\$0
\$440,540	Seeds, cuttings, or plants	\$246,500								\$194,040				\$440,540
\$141,180	Pots or containers	\$118,500								\$22,680				\$141,180
\$0	Marketing Containers													\$0
\$37,340	Growing Media	\$32,300								\$5,040				\$37,340
\$40,360	Fertilizer and chemicals	\$26,500								\$13,860				\$40,360
\$60,160	Tags	\$40,000								\$20,160				\$60,160
\$0	Sales Commissions													\$0
\$0	Other													\$0
\$719,580	<b>Total Direct Costs</b>	\$463,800	\$0	\$0	\$0	\$0	\$0	\$0	\$0	\$255,780	\$0	\$0	\$0	\$719,580
	<b>Salaries</b>													\$0
\$39,667	Overhead salaries	\$3,305.58	\$3,305.58	\$3,305.58	\$3,305.58	\$3,305.58	\$3,305.58	\$3,305.58	\$3,305.58	\$3,305.58	\$3,305.58	\$3,305.58	\$3,305.58	\$39,667
\$0	FICA													\$0
\$0	Unemployment insurance													\$0
\$0	Workmen's compensation													\$0
	<b>Wages</b>													\$0
\$713,502	General wages (exact withdrawal)	\$84,250	\$84,250	\$84,250	\$84,250	\$168,500	\$82,000						\$126,000	\$713,500
\$0	FICA													\$0
\$0	Unemployment insurance													\$0
\$0	Workmen's compensation													\$0
	<b>Utilities</b>													\$0
\$77,566	Heating fuel / Machinery Fuel	\$12,928	\$12,928	\$12,928	\$6,464	\$6,464						\$12,928	\$12,928	\$77,566
\$40,352	Electricity	\$3,363	\$3,363	\$3,363	\$3,363	\$3,363	\$3,363	\$3,363	\$3,363	\$3,363	\$3,363	\$3,363	\$3,363	\$40,352
\$5,394	Telephone	\$450	\$450	\$450	\$450	\$450	\$450	\$450	\$450	\$450	\$450	\$450	\$450	\$5,394
\$164	Water	\$14	\$14	\$14	\$14	\$14	\$14	\$14	\$14	\$14	\$14	\$14	\$14	\$164
	<b>Overhead</b>													\$0
\$7,930	Interest	\$661	\$661	\$661	\$661	\$661	\$661	\$661	\$661	\$661	\$661	\$661	\$661	\$7,930
\$43,779	Repairs	\$3,648	\$3,648	\$3,648	\$3,648	\$3,648	\$3,648	\$3,648	\$3,648	\$3,648	\$3,648	\$3,648	\$3,648	\$43,779
\$25,681	Taxes	\$2,140	\$2,140	\$2,140	\$2,140	\$2,140	\$2,140	\$2,140	\$2,140	\$2,140	\$2,140	\$2,140	\$2,140	\$25,681
\$36,946	Insurance	\$3,079	\$3,079	\$3,079	\$3,079	\$3,079	\$3,079	\$3,079	\$3,079	\$3,079	\$3,079	\$3,079	\$3,079	\$36,946
\$11,077	Advertising	\$923	\$923	\$923	\$923	\$923	\$923	\$923	\$923	\$923	\$923	\$923	\$923	\$11,077
\$0	Dues and Subscriptions	\$0	\$0	\$0	\$0	\$0	\$0	\$0	\$0	\$0	\$0	\$0	\$0	\$0
\$7,331	Travel and Entertainment	\$611	\$611	\$611	\$611	\$611	\$611	\$611	\$611	\$611	\$611	\$611	\$611	\$7,331
\$9,389	Office Expense	\$782	\$782	\$782	\$782	\$782	\$782	\$782	\$782	\$782	\$782	\$782	\$782	\$9,389
\$19,244	Professional Fees	\$1,604	\$1,604	\$1,604	\$1,604	\$1,604	\$1,604	\$1,604	\$1,604	\$1,604	\$1,604	\$1,604	\$1,604	\$19,244
\$0	Equipment Rental	\$0	\$0	\$0	\$0	\$0	\$0	\$0	\$0	\$0	\$0	\$0	\$0	\$0
\$1,792	Land Rental	\$149	\$149	\$149	\$149	\$149	\$149	\$149	\$149	\$149	\$149	\$149	\$149	\$1,792
\$0	Contributions	\$0	\$0	\$0	\$0	\$0	\$0	\$0	\$0	\$0	\$0	\$0	\$0	\$0
\$0	Bad Debt	\$0	\$0	\$0	\$0	\$0	\$0	\$0	\$0	\$0	\$0	\$0	\$0	\$0
\$26,522	Miscellaneous	\$2,210	\$2,210	\$2,210	\$2,210	\$2,210	\$2,210	\$2,210	\$2,210	\$2,210	\$2,210	\$2,210	\$2,210	\$26,522
\$1,785,916	<b>SUBTOTAL</b>	\$583,917	\$120,117	\$120,117	\$113,653	\$197,903	\$104,939	\$22,939	\$22,939	\$278,719	\$22,939	\$35,867	\$161,867	\$1,785,914
	Owners' Withdrawal													\$0
\$1,785,916	<b>TOTAL CASH PAID OUT</b>	\$583,917	\$120,117	\$120,117	\$113,653	\$197,903	\$104,939	\$22,939	\$22,939	\$278,719	\$22,939	\$35,867	\$161,867	\$1,785,914
\$128,362	Cash Position (end of month)	-\$449,555	-\$567,671	-\$677,788	-\$269,198	\$282,899	\$477,960	\$505,021	\$522,082	\$263,363	\$260,424	\$224,558	\$462,691	\$462,691

## Growing Farms: The Impacts of Oregon's Beginning Farmer Program

*Kristin Pool, Garry Stephenson, Nick Andrews, Melissa Fery, Amy Garrett, Melissa Matthewson, and Maud Powell, Oregon State University Small Farms Program, Corvallis, OR*

**Growing Farms: The Impacts of Oregon's Beginning Farmer Program**  
**Kristin Pool, Garry Stephenson, Nick Andrews, Melissa Fery, Amy Garrett,**  
**Melissa Matthewson, and Maud Powell**

**Oregon State University Small Farms Program, Corvallis, OR**

### **Introduction**

The increasing age of farmers is a well-documented concern. As farmers retire, we face an unprecedented transfer of agricultural land. Fortunately, this *crisis of attrition* (Shute, 2011) in agriculture is occurring along with the growth of the local food movement. The *local food movement* is gaining influence in our agricultural system, economy, and taking farmers to rock star status.

Today, more and more beginning farmers are drawn to farming as a career that allows them an opportunity to combine their occupational and personal life goals. However, many of these newcomers do not possess the skills needed to operate a farm. Those with farming skills still struggle to create a sustainable farm business. As a result “Growing Farms: Successful Whole Farm Management” was developed by Oregon State University’s Small Farm Program in 2007 to address the complex needs of farmers starting, expanding, and re-envisioning their farm business.

### **Growing Farms Curriculum**

As a result, Growing Farms meets farmers’ needs through whole farm planning, skill building, experiential learning and networking. The 8-week face-to-face course uses a whole farm planning framework to integrate the physical, biological, family, and financial components of farming. The course covers six content areas, which have been refined in workshops since 2007. The curricular framework and titles are:

- **Dream It: Strategic Planning.** Defining family and farm values and assets to build a strong farm plan. Includes assessing soil and water capabilities to assist cropping system planning.
- **Do It: Farm Operations.** Planning for human and mechanical farm/ranch infrastructure including matching efficient farm equipment and renewable energy options with the production system, the role of the family in providing necessary farm/ranch business skills and labor, managing farm/ranch infrastructure for a successful production system.
- **Grow It: Production.** Managing the biological segment of the farm/ranch with the essentials of agro-ecology for annual and perennial cropping and livestock systems. Strategies to manage risk through soil health, conservation biological control, and other approaches.

- **Manage It: Farm Finances.** Implementing sound financial planning for a successful business including record keeping, production cost, and farm/ranch business structures.
- **Sell It: Marketing Strategies.** Planning for an array of wholesale and direct farm/ranch marketing options and the connection between crop production decisions and marketing channel decisions.
- **Keep It: Managing Risk and Credit.** Planning for sustaining the new farm or ranch including integrating various risk management tools such as liability and crop insurance, licenses and entrepreneurship and succession planning.

### **Course Impacts and Evaluation**

Growing Farms has had positive impacts to Oregon's local and state economy, small farm community, and agricultural landscape. Growing Farms has assisted new farms in evaluating and managing their operations. Over 330 participants have completed Growing Farms in 5 regions of Oregon since 2007. Each program is evaluated to assess its effectiveness.

We asked participants whether they have started or planned to start or expand their farm business.

- 61 percent of participants plan to start a farm business as a result of the course.
- 38 percent of participants plan to expand a farm business as a result of the course.
- 5 percent of participants said they do not plan to pursue a farm business

While increasing the number of new farms is an exciting outcome of Growing Farms, the OSU Small Farms Program equally values the decision by some participants to not pursue farming. This decision saves participants potential debt, unsuccessful land transfers, and other hardship.

Those participants continuing their interest in farming feel better prepared to get started. We asked participants whether they felt better prepared on several key farm business related dimensions.

- 95 percent felt better prepared to take the steps to set up a farm business.
- 97 percent felt better prepared to evaluate marketing options that fit crop and farm goals.
- 92 percent felt better prepared to establish goals, values and mission to guide decisions for their farm business.
- 88 percent felt better prepared to establish a basic record keeping and accounting system.

### **Responding to Beginning Farmers Needs**

The OSU Small Farms Program has made improvements to Growing Farms in response to course evaluations and the needs of Oregon's diverse farm community. Novel curricular tools, formalized farmer networks and experiential learning have enhanced the content of Growing Farms. Additionally, the Small Farms Program is in the process of piloting new opportunities for further beginning farmer education. Below are some examples.

## **Growing Farms**

Successful Whole Farm Management Planning Book—Think It! Write It! was published in 2011. The planning book is an innovative guide that helps participants navigate the planning process by providing them space to organize and retain a record of their thoughts, goals, and notes. The planning book prompts participants to write down their thoughts and provides prompts that guide them to more fully think through their lifestyle needs, financial situation, occupational preferences and skill set. By documenting their various constraints and opportunities, the participants are more able to incorporate them into their farm plan and thus more fully utilize their opportunities and address their constraints.

Growing Farms has always identified networking as a vital component of the course. Evaluation data reaffirmed networking as an important component of the course.

*[Growing Farms] gave me the confidence to find and use resources in the community. I now feel like we have a wonderful support network, which makes starting a business feel less overwhelming.*

-Katie Coppoletta, Fiddlehead Farm, Corbett, OR

To further improve the networking component of Growing Farms, women farming networks have been created in three regions of the state. Female participants of Growing Farms are utilizing these networks to become more incorporated in the small farms community and gain the myriad of benefits of connecting with other female farmers.

Growing Farms focuses on whole farm planning and farm business management skills. Over time, it became clear that many participants needed access to education focused on farming skills along with farm management. In response, in 2011 the Small Farms Program piloted Growing Agripreneurs. Growing Agripreneurs is developing a toolkit and curriculum for establishing teaching farms on OSU research farms or for use by non-profit organizations. The program provides hands-on training through a season of farming annuals and perennials on a small scale. In addition, Growing Farms is being used to support a program focused on urban scale farming (<1 acre) in the Portland, OR, metropolitan area. The Beginning Urban Farmer Apprentice program takes participants through 500 hours of training over 7 months in “hand scale” horticulture production using organic methods. Both programs link participants with Growing Farms to provide a whole farm management framework.

### **Increasing Sustainability and Accessibility**

Growing Farms has been widely successful and has potential to expand to other regions. However, the face-to-face program is limited logistically to several sites per year consistent with staffing service areas and budgets. The Small Farms Program has struggled to find a way to offer a beginning farmer education course that is more accessible and fits staffing levels.

As education providers face shrinking resources many have concluded that distance education is vital to the effectiveness and accessibility of their programs (Dromgoole and Boleman, 2006). The Small Farms Program has determined that education in the form of online courses is within the capability of beginning farmers and ranchers and is the most efficient way to reach remote audiences. By converting Growing Farms to the online environment not only will the course be more accessible, but it will also

incorporate groundbreaking features. This strategy will enhance the success of beginning farmers and ranchers and is practical for budgets and staffing and sustainable in terms of longevity.

## References

Dromgoole, D., and Boleman, C. (2006). Distance education: Perceived barriers and opportunities related to Extension program delivery. *Journal of Extension* 44(5) [online],

Shute, L.. (2011). *Building a Future with Farmers: Challenges Faced by Young, American Farmers and a National Strategy to Help Them Succeed*. National Young Farmer Coalition Report.  
<http://www.youngfarmers.org/newsroom/building-a-future-with-farmers-october-2011/>

## Session 3 D

### Track/Session: Research and Extension Priorities/Small Farming Systems Part II

#### Livestock Integrated Parasite Management in North Carolina

**Niki Whitley, Ph.D.\*, Keesla Moulton, Ph.D., Roberto Franco, Allison Cooper<sup>1</sup> and Rene Jackson**

North Carolina A&T State University, Greensboro, North Carolina, 27411, <sup>1</sup>Orange County Animal Control and Shelter, Hillsborough, North Carolina

#### Livestock Integrated Parasite Management in North Carolina

**Niki Whitley, Ph.D.\*, Keesla Moulton, Ph.D., Roberto Franco, Allison Cooper<sup>1</sup> and Rene Jackson**

**North Carolina A&T State University, Greensboro, North Carolina, 27411, USA**

**<sup>1</sup>Orange County Animal Control and Shelter, Hillsborough, North Carolina, 27278, USA**

#### Introduction

The profitability of livestock farms is impaired by improper internal parasite (worm) control methods, even resulting in total dewormer failure on some farms. Parasites cause animal production losses, and dewormer resistance is a problem in multiple species. However, most integrated internal parasite training in North Carolina, and nationwide, has targeted goats and sheep. A needs assessment conducted for North Carolina Extension field staff indicated a need for multiple species parasite management training. Educational materials and evaluation tools were also identified as needs.

To support profitable and sustainable farms and global food security, this program was designed to train Extension field staff and other agricultural professionals in livestock integrated parasite management. Training is also provided to small farmers in collaboration with the trained field staff and other agricultural professionals. The objectives are to help livestock owners reduce parasite problems, identify parasite dewormer resistance, extend the life of chemical dewormers that work for them, reduce chemical use, and increase animal health and performance.

## Program Description

Impacts of existing programs involving integrated parasite management in sheep and goats were evaluated. Based on the success of those efforts and the results of a needs assessment of North Carolina Extension field staff, additional programming was established and/or updated for integrated parasite control training for several livestock species (cattle, horses and pigs along with goats and sheep). External grant funding was obtained through the USDA Southern region Sustainable Agriculture Research and Education (SARE) Professional Development Program. Extension field staff training is offered in several formats and post-training support is provided to trainers through invited presentations and general technical support.

Immediate increases in knowledge, skills and abilities are often evaluated by an electronic polling (“clicker”) type training system, the use of which increased survey response rates from 20 percent to 100 percent (SNAP™, Audience Response Systems, Inc., Evansville, IN). Needs assessments are conducted using the same system, surveys or discussion groups, and changes are made to programming based on impacts and assessments. Mid- to long-term impacts are measured using surveys designed for agents to fill out during farm visits with input from the producer.

Delivery methods include train-the-trainer sessions and invited presentations. The train-the-trainer sessions for Cooperative Extension agents and agriculture professionals include the following options:

- Classroom training
- Hands-on fecal egg counting and/or FAMACHA© eye lid color scoring training
- On-farm training in fecal egg count reduction testing
- Provision of educational materials for training farm owners/operators
- Provision of evaluation tools to use with impact assessment of farm owners/operators

Invited presentations are hosted by Extension field staff, University and Community College faculty or community-based organizations with both classroom and hands-on options available.

Program educational tools include training manuals or notebooks with handouts, portable USB storage devices or CDs with electronic materials including presentations and evaluation tools designed for trainers. Microscope and fecal egg counting kits have been provided to at least 20 County Extension offices for use in training producers.

The program is marketed based on the target audience (field staff, livestock owners, or others):

- Online extension learning management system (field staff)
- Annual in-service announcements (field staff)
- Word of mouth, phone, email (field staff and owners)
- Postcards, letters, fliers (owners)
- Newspapers, radio, local TV (owners)
- Social media and newsletters (owners)
- National/regional posters and oral presentations (others)

## Results/Impacts

Train-the-trainer workshops and invited presentations to farmers and trainers resulted in over 400 individuals trained in a two-year period (Figure 1).

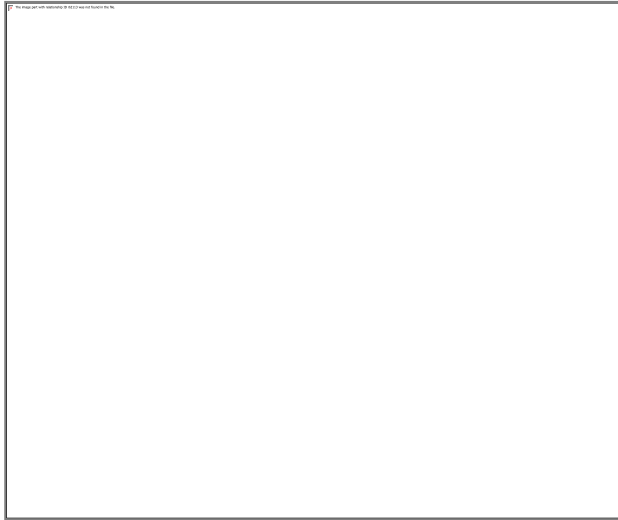

Figure 1. Number of individuals trained in integrated livestock parasite management.

The train-the-trainer workshops in South Carolina provided continuing education credits to five veterinarians. Three additional veterinarians and several veterinary technicians in N.C. have been trained.

A notebook was developed and provided to trainers. It included printed as well as electronic materials such as presentations, evaluation tools, handouts and fact sheets to use with livestock owners.

Fecal egg counting kits including a microscope were offered to livestock agents in N.C. who received and also agreed to offer parasite management training to livestock owners (32 agents received kits).

Results from evaluation of train-the trainer sessions indicated that participants considered the information relevant to their needs and that they would use the information with their clientele. At least 27 have provided training to date and others have events planned.

Evaluation of existing NC Cooperative Extension sheep and goat parasite control programming indicated that 91 percent of respondents felt that FAMACHA®/Integrated Parasite Management training made a difference in their ability to control or monitor parasitism in their flock. The majority (69%) also indicated that they saved money in the first year after training and treated animals less often than they did before training (Figure 2) .



Figure 2. Percentage of North Carolina goat and sheep owners responding to a small ruminant internal parasite control survey (57 respondents) who treated for parasites more often, the same or less often than before attending an integrated parasite management training workshop.

Extension field staff reported that livestock owners are using the microscopes and kits to do fecal egg counting in order to make deworming decisions and to determine if



dewormers are working on their farms. One agent reported that she was able to help a farmer save goats that were dying of worms.

At least five pasture pork producers have changed deworming protocols on their farms. This will help them raise a higher quality product and use less feed to market, improving overall farm profitability.

On-farm fecal egg count reduction training was conducted with Extension field staff on 28 farms consisting of 875 animals (goats, cattle, horses). The total savings on dewormer for all owners was \$8,175 initially, and if integrated management practices continue, will be \$5,979 per year. In addition, animal performance would increase and mortality would decrease while the reduction in chemical dewormers used would also be a benefit to the environment.

#### Summary/Future Plans

The program is very popular and has helped livestock owners manage parasites, so it will continue. The primary author is leading training manual updates for the American Consortium for Small Ruminant Parasite Control. Livestock integrated parasite management training materials are being updated for editing and publication for widespread use.

The authors acknowledge the efforts of Extension field staff and other collaborators such as Dr. Ray Kaplan, Dr. Mark Alley, Dr. Morgan Morrow and Dr. Ralph Noble, among others.

### **Research and Extension Highlights of the New Integrated Pest Management Program at Lincoln University of Missouri**

*Jaime C. Piñero, Lincoln University Cooperative Research and Extension, Jefferson City, MO*

### **Research and Extension Highlights of the New Integrated Pest Management Program at Lincoln University of Missouri**

**Dr. Jaime C. Piñero**

**Lincoln University Cooperative Research and Extension, Jefferson City, MO**

#### **Introduction**

The therapeutic approach of killing pest organisms with toxic chemicals has been the prevailing pest control strategy for many years. Considering that small farms are characterized by having high biological diversity embedded within a high crop diversity, then truly satisfactory solutions to pest problems require a shift to understanding and promoting naturally occurring biological control agents. In addition to these, other inherent strengths should be understood and promoted as components of total agricultural ecosystems and our cropping systems should be designed so that these natural forces keep the pests within acceptable bounds (Lewis et al., 1997). This can only be accomplished with a good understanding of the types of ecological interactions among pest organisms with their natural enemies, with crop plants and adjacent habitat, and also the influence of farming practices. The therapeutic use of

pesticides is therefore unsustainable and should be the last rather than the first line of defense. In this presentation, I will emphasize that Integrated Pest Management (IPM) is applied ecology in action and that truly sustainable, including organic, systems cannot be developed without an understanding of the concepts and practices of IPM. I strongly believe that IPM can (and should) be an effective way of reducing farm inputs while balancing the ecological, social, and economic aspects of farming to move toward sustainability.

### **Small Farms in Missouri**

In 2007, Missouri had 107,825 farms, ranking 2<sup>nd</sup> in the nation after Texas (USDA, 2007). The average farm size was 269 acres, which is below the national average of 418 acres. Of all farms, 27 percent were less than 50 acres, and 64 percent of them were less than 180 acres. The farm income was less than \$50,000 for 83 percent of the farms. In terms of vegetable crops, the average size of a vegetable farm was about 24 acres in Missouri, and 1,171 out of a total of 1,335 vegetable farms (87.7 percent) were less than 15 acres. These data show clearly that the majority of farms in Missouri, in particular vegetable farms, were small farms. Small-scale farming also grew in diversity. For example, the number of operators of Hispanic, Asian and American Indian origin has been increasing since 2002.

### **The Lincoln University IPM Program**

In Missouri, there is a high need to bring research-based information on all aspects of IPM to the state's citizens. The Lincoln University (LU) IPM Program was established in April, 2010, in response to that need. In accordance with the mission of the 1890 Land-Grant Extension System, the ultimate goal of LU Cooperative Extension (LUCE) is "to help diverse audiences with limited resources improve their quality of life through the application of educational and research-based information focused on critical issues and needs". Because limited-resource and minority clients are the number one priority for LUCE, then delivering research-based information that addresses the current needs of Missouri's small and limited-resource farmers is critical to LUCE's ability to fulfill its mission and deliver high-quality services.

### **IPM Program Vision and Mission**

#### ***Vision***

The LUCE IPM program delivers unbiased, research-based, sustainable, and timely solutions to pest problems in vegetable and small fruit farms, thereby helping to maximize economic returns and environmental health.

#### ***Mission***

- To educate farmers on the ecological benefits of implementing IPM practices
- To increase the level of adoption of IPM components
- To increase the effectiveness of pest management techniques
- To develop science-based pest management programs that are economically and environmentally sustainable, and socially appropriate
- To protect human health and the environment by reducing pesticide-related risks

## Research Highlights

Since its inception in the year 2010, the main research goal of the LU IPM program has been to develop effective and grower-friendly IPM approaches to manage key insects of small fruits and vegetables. Spotted cucumber beetle (*Diabrotica undecimpunctata howardii*), striped cucumber beetle (*Acalymma vittatum*) (both Coleoptera: Chrysomelidae) and squash bug (*Anasa tristis*) (Heteroptera: Coreidae) have consistently been identified as the most damaging insect pest of cucurbits in most areas of the United States where cucurbit crops are grown including Missouri. In response to the farmer's need to manage these pests using more sustainable methods, in 2011, the LU IPM program initiated research aimed at developing truly effective IPM methods to combat these pests. One approach that has shown promise for use on small farms is termed trap cropping. The trap cropping approach functions by delivering pest-behavior-modifying stimuli that attract the pest to the border areas where they can be managed in a more environmentally friendly manner, thereby reducing – or even eliminating, pest numbers resulting in reduced or no need for chemical application to the crop (Cook et al., 2007). Owing to its high attractiveness to cucumber beetles and low susceptibility to bacterial wilt (McGrath and Shishkoff, 2000), Blue Hubbard squash (*Cucurbita maxima*) was shown to perform well as a perimeter trap crop for *A. vittatum* on summer squash (Pair, 1997) and cantaloupe (Boucher and Durgy, 2004). More recently, Blue Hubbard squash was evaluated as a perimeter trap crop for butternut squash (*C. moschata*) (Cavanagh et al., 2009). Our research shows that both butternut squash and Blue Hubbard squash are very attractive to *D.u howardii* and *A. vittatum* and also to *A. tristis*, the three most important pests of cucurbit crops in Missouri and other regions where cucurbit crops are grown. This approach is highly compatible with organic production.

## On-Farm Research

Various farmers in Missouri have evaluated the effectiveness of the trap cropping approach. Examples include Jose Fonseca, a vegetable farmer from St. Peters, MO, who in 2011 evaluated Blue Hubbard squash as a trap crop to protect zucchini plants (seedlings) both in the hoop house and in the field. He was very pleased with the results. By using trap crops he was able to reduce insecticide sprayed against cucumber beetles by 95 percent compared to 2010 (and previous years) when he applied a systemic insecticide to the seedlings followed by weekly applications of foliar insecticides throughout the season to protect his crop. In 2012, Fonseca used the trap cropping approach again with excellent results. Not only did he harvest excellent quality zucchinis without spraying any insecticides to his cash crop, but he also learned for the first time about the various species of beneficial insects that were present in his cash crop which were not killed by insecticides as done in previous years.

## Extension Highlights

Our Extension activities include one-to-one interactions, workshops, presentations, Extension publications, and on-farm demonstration trials. Our delivery methods are varied, and reflect the varying needs of our clientele. Amish farmers are reached through workshops that do not rely on power point presentations, but rather on printed information and hands-on activities, printed newsletters and

educational information. Hmong farmers are reached in locations as close as possible to their farming operations using translators; educational materials on basic IPM concepts written in Hmong are also provided. Hispanic farmers are reached through one-to-one interactions and through workshops in Spanish with printed information in English and/or Spanish. For farmers who prefer online information delivery, we provide support via e-mail, links to resources, fact sheets, and news articles.

**Table 1. Summary of Activities**

For the past 2 years, stakeholders have learned the fundamental multi-disciplinary IPM knowledge and skills in order to put those into practice.

Skill sets have been taught in the classroom and the field through hands-on training and demonstrations. A summary of activities conducted from April

14, 2010 to August 31, 2012 is shown on in Table 1.

Type of Activity	Total No. participations	No. Direct Contacts	No. Indirect Contacts	Total Contacts	% of minority & under-represented farmers reached
Workshops (e.g., on IPM, crop-specific)	21	575	375	950	38.4%
Presentations at Seminars and Conferences	10	691	0	691	ND
Field Days	9	886	95	981	ND
Grower meetings	2	51	0	51	ND
Contributions Newsletters	14	0	1,900+	1,900+	ND
Other Educational activities including State Fair	3	42	140+	182+	ND
ISE workshops	2	68	0	68	4.8%
Direct advice to farmers (1-on-1 interactions)	53+	53+	0	53+	41.5%+

Train-the-trainer workshops:

Two train-the-trainer

workshops were conducted (2011 and 2012) with support from the Missouri Sustainable Agriculture Research and Education (SARE) program. The main goal of these workshops was to provide training to agricultural professionals and educators in the Missouri's Cooperative Extension Service on the most up-to-date information on sustainable IPM for vegetables (2011) and small fruits (2012).

### Outcomes

All educators increased their knowledge and awareness of the economic and environmental benefits of implementing IPM practices for vegetable and small fruit production in Missouri. A 9-month post-workshop survey that was conducted using Google documents (response rate: 57.9 percent = 22/38 educators) revealed the following: (1) 779 clients were assisted in a 9-month period using information covered in the 2011 workshop, (2) 40 newsletter articles, newspaper columns/radio shows were published using IPM information from the workshop, (3) 125 farms were visited and IPM was discussed with farmers, (4) 244 one-on-one interactions, and (5) 68.2 percent (15/22) of the Extension educators interacted with minority/limited-resource farmers.

### Conclusions and Future Plans

The main goal of the LU IPM program is that Missouri's farmers increase the level of awareness and adoption of IPM components, leading to increased profits and environmental benefits while decreasing

pesticide use. We will continue offering intensive, hands-on workshop to both farmers and Extension educators to provide them with a comprehensive understanding of the IPM concept, with focus on the PAMS (Prevention, Avoidance, Mitigation and Suppression) approach, emphasizing insect ID, monitoring and thresholds, biological and cultural controls, and complemented with general information about pesticides (including organic materials) and biopesticides. Compatibility of pest management tactics and conservation of pollinators and beneficial insects will continue to be emphasized as part of our outreach activities.

## References

- Boucher, T.J. and Durgy, R. (2004). "Demonstrating a perimeter trap crop approach to pest management on summer squash in New England" *J. Extension* (<http://www.joe.org/joe/2004october/rb2.php>)
- Cavanagh, A., Hazzard, R., Adler, L.S., and Boucher, J. (2009) "Using trap crops for control of *Acalymma vittatum* (Coleoptera: Chrysomelidae) reduces insecticide use in butternut squash." *J. Econ. Entomol.* 102: 1101-1107.
- Cook, S.M., Khan Z.R., and Pickett, J.A. (2007). The use of push-pull strategies in Integrated Pest Management. *Annu. Rev. Entomol.* 52: 375-400.
- Lewis, W.J., van Lenteren, J.C., Phatak, S.C., and J.H. Tumlinson. (1997). "A total system approach to sustainable pest management." *Proc. Natl. Acad. Sci. USA* 94: 12243-12248.
- McGrath, M.T., and Shishkoff, N. (2000). "Comparison of cucurbit crop types and cultivars for their attractiveness to cucumber beetles and susceptibility to bacterial wilt". *Biol. & Cult. Tests* 15:154.
- Pair, S. D. (1997). "Evaluation of systemically treated squash trap plants and attracticidal baits for early-season control of striped and spotted cucumber beetles (Coleoptera: Chrysomelidae) and squash bug (Hemiptera: Coreidae) in cucurbit crops". *J. Econ. Entomol.* 90: 1307-1314.
- USDA.( 2007). Census of Agriculture, National Agricultural Statistics Service, Washington DC

## Development of Intelligent Spraying Systems for Tree Crop Production

**Heping Zhu, Richard Derksen, Charles Krause, Hongyoung Jeon, Jiabing Gu, Xiang Dong, and Weidong Jia**, USDA-ARS Application Technology Research Unit, 1680 Madison Avenue, Wooster, OH; **Erdal Ozkan**, Department of Food, Agricultural, and Biological Engineering, The Ohio State University, Columbus, OH; **Mike Reding and Chris Ranger**, USDA-ARS Application Technology Research Unit, Horticultural Insect Laboratory, Wooster, OH; **Luis Canas**, The Ohio State University Ohio/OARDC, Wooster, OH; **Jim Locke**, The Ohio State University Extension, Painesville, OH; **Stan Ernst**, USDA-ARS Application Technology Research Unit, Greenhouse Production Research Laboratory, Toledo, OH; **Randy Zondag**, The Ohio State University, Columbus, OH 43210; **Amy Fulcher**, University of Tennessee, Knoxville, TN; **Robin Rosetta**, Oregon State University Extension, Aurora, OR; **Yu Chen, Hui Liu, and Yue Shen**, The Ohio State University/OARDC, Wooster, OH



**Development of Intelligent Spraying Systems for Tree Crop Production**

**Heping Zhu, Richard Derksen, Charles Krause, Hongyoung Jeon, Jiabing Gu, Xiang Dong, and Weidong Jia**

**USDA-ARS Application Technology Research Unit, 1680 Madison Avenue,  
Wooster, OH**

**Erdal Ozkan,  
Department of Food, Agricultural, and Biological Engineering,  
The Ohio State University, Columbus, OH**

**Mike Reding and Chris Ranger,  
USDA-ARS Application Technology Research Unit, Horticultural Insect  
Laboratory, Wooster, OH**

**Luis Canas,  
Department of Entomology,  
The Ohio State University Ohio/OARDC, Wooster, OH**

**Jim Locke,  
Commercial Horticulture and Natural Resources, The Ohio State University  
Extension,  
Painesville, OH**

**Stan Ernst,  
USDA-ARS Application Technology Research Unit,  
Greenhouse Production Research Laboratory, Toledo, OH**

**Randy Zondag,  
Department of Agricultural, Environmental, and Development Economics,  
The Ohio State University, Columbus, OH 43210;**

**Amy Fulcher,  
Department of Plant Sciences, University of Tennessee, Knoxville, TN 37996;**

**Robin Rosetta,  
Oregon State University Extension, North Willamette Research and Extension  
Center,  
Aurora, OR**

---

**Yu Chen, Hui Liu, and Yue Shen,**  
**Department of Food, Agricultural, and**  
**Biological Engineering, The Ohio State University/OARDC, Wooster, OH**

---

## **Introduction**

The fruit and ornamental nursery industries produce an abundance of food, flowers, nursery shrubs, and trees to improve our lifestyle and beautify our environment. This abundance is predicated on the use of pesticides to protect them from pests. However, the application efficiency of conventional pesticide spray technologies for crop protection is very low. Consequently, excessive pesticides are often applied to target and non-target areas, resulting in greater production costs, worker exposure to unnecessary pesticide risks, and adverse contamination of the environment. The industries have constantly demanded the development of new advanced intelligent sprayers that delivers pesticides economically, accurately and requires minimum human inputs during the entire spray application process.

To achieve the industrial demands, two types of experimental variable-rate precision sprayers were developed as a prototype of new generation sprayers for fruit and ornamental nursery crop applications. The first sprayer is a hydraulic vertical boom spraying system which is proposed to spray relatively small narrow trees such as liners (Jeon et al., 2011; Jeon and Zhu, 2012), and the second sprayer is an air-assisted spraying system which is proposed to spray wide varieties of nursery and fruit tree crops (Chen et al., 2012; Gu et al., 2012).

## **Materials and Methods**

The variable-rate hydraulic boom sprayer prototype (Fig. 1) was the integration of a 20 Hz detecting frequency ultrasonic sensing system, a custom-designed sensor-signal analyzer and a microprocessor controller, and two vertical booms coupled with five opposing pairs of equally spaced variable-rate nozzles. The sensing system detected the occurrence of a plant, its size and volume, and the sprayer travel speed. The controller along with a microprocessor analyzed sensor signals and actuates pulse width modulated (PWM) solenoid valves in real time. This action allowed the sprayer to provide variable flows to nozzles automatically based on the canopy structure and presence.



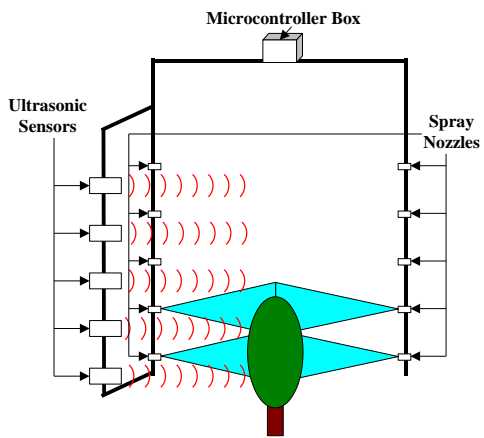

(a) Sensors to detect canopy and control spray nozzles



(b) sprayer prototype

**Figure 1. Ultrasonic sensor-controlled hydraulic vertical boom sprayer to provide variable-rate functions based on tree size, shape and occurrence.**

The variable-rate air-assisted sprayer prototype (Fig. 2) implemented with a high-speed laser scanning sensor to control the spray output of individual nozzles to match tree canopy characteristics in real time. The sprayer mainly consisted of a laser scanning sensor control system and an air and liquid delivery system. Each nozzle in the delivery system, coupled with a pulse width modulation (PWM) solenoid valve, achieved variable-rate delivery based on the occurrence, height, width of the target tree and its foliage density. Other components of the sensor control system included a unique algorithm for variable-rate control that instantaneously processes the measurements of the canopy surfaces.

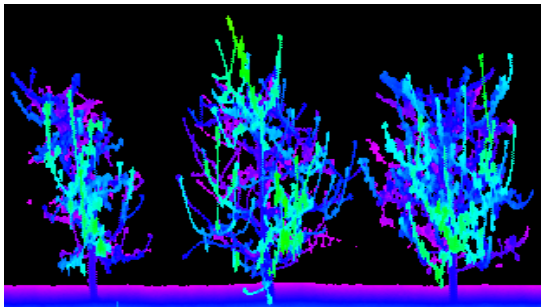

(a) Images of trees scanned by sensor



(b) Air-assisted intelligent sprayer

**Figure 2. Laser scanning sensor-controlled air assisted sprayer to provide variable-rate functions based on tree sectional canopy volume, density and occurrence**

For the variable-rate air-assisted sprayer, field tests were conducted in an orchard to investigate spray deposition uniformity inside canopies and off-target losses in April when trees just started leafing, in May when trees had about half canopy growth, and in June when trees had fully-established foliage. Spray volume savings between the variable-rate sprayer and a conventional air blast sprayer in an orchard were compared at three different growing stages.

### **Results and Discussion**

Field test results demonstrated that the variable-rate hydraulic boom sprayer could reduce spray volume up to 86 percent and 70 percent compared to the 100 gpa and conventional tree-row volume based rate applications, respectively. Therefore, this newly developed variable-rate sprayer has great potential to bring great reductions in pesticide use for narrow tree (such as liners) productions. After the sprayer prototype was tested and confirmed it could reach the expected performances, a retrofit variable-rate spray unit was developed for a conventional high ground clearance vertical boom sprayer and tested in a commercial nursery in Oregon. For field comparison tests, the half side of the sprayer uses the retrofit unit, and the other half side of the sprayer remains the same as the conventional spray setup. Applicators only use two switches (On and Off) to operate the retrofit unit while all other spray functions are operated automatically by the microprocessor. Powdery mildew and aphids were evaluated for the comparison between the intelligent and conventional spray system applications. In 2011 season, there was no statistical difference in the control of the powdery mildew or aphids between the conventional and the intelligent spray systems.

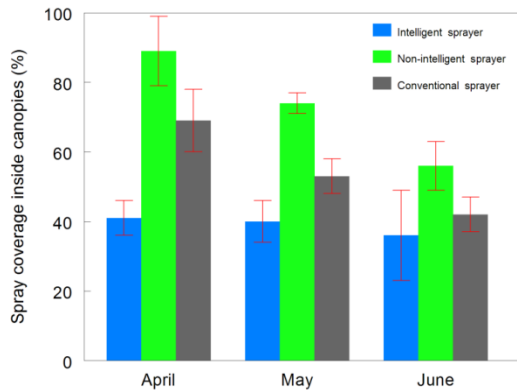

**Figure 3. Comparisons of spray coverage inside tree canopies at different growth stages among three spray application methods.**

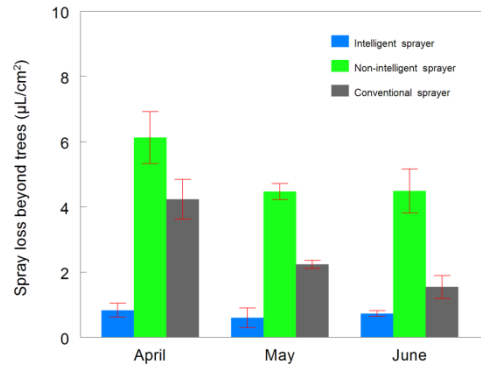

**Figure 4. Comparisons of spray losses beyond tree canopies at different growth stages among three spray application methods.**

T

The spray coverage and deposition inside canopies from the intelligent air-assisted sprayer were much more stable over different growth stages (Fig. 3), and had significantly less spray losses on the ground and beyond target trees (Fig. 4) for all three growth stages than the constant-rate applications. Compared to the constant application rate of 50 gpa, the new sprayer reduced the application rate by 70 percent in April, 66 percent in May and 52 percent in June (Fig. 5). Hence, the pesticide spray volume reduction with the new sprayer is obvious. These preliminary tests have demonstrated that the new sprayer has the capability to achieve variable spray rates for different canopy volumes and densities.

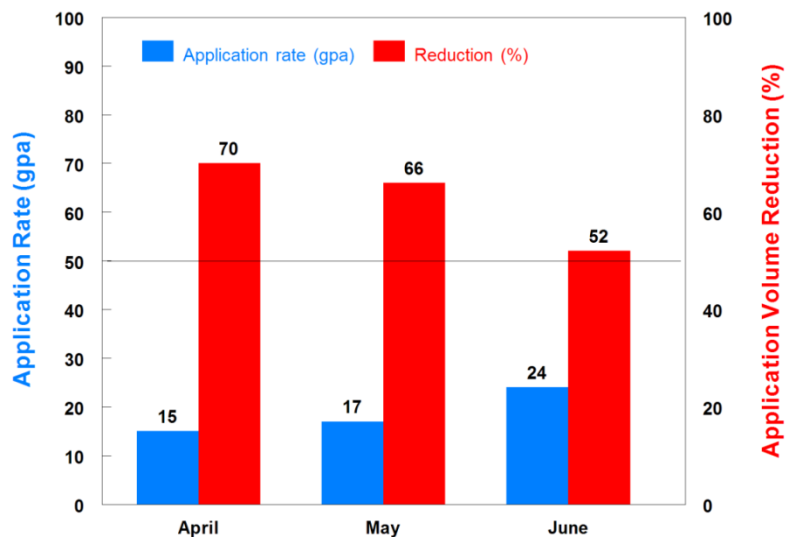

Figure 5. Spray rates and percent volume reductions by using the air-assisted intelligent sprayer in April, May and June, compared with the conventional 50 gpa application rate.

Therefore, compared to conventional sprayers, intelligent sprayers greatly reduced variations in spray deposition due to changes in tree growth, increased consistence of spray deposition uniformity inside canopies at different growth stages, minimized off-target losses, and reduced pesticide use.

### Acknowledgements

Authors express their appreciation to A. Clark, K. Williams and B. Nudd for their assistance throughout the research. This research was supported by USDA NIAR SCRI (Grant No. 2009-51181-06002).

### References

- Jeon H.Y., Zhu H., Derksen R.C., Ozkan HE, Krause CR, Fox R.D. (2011). "Performance Evaluation of a Newly Developed Variable Rate Sprayer for Nursery Liner Applications." Transactions of the ASABE 54(6):1997-2007.
- Jeon H.Y., Zhu H. (2012). "Development of Variable-Rate Sprayer for Nursery Liner Applications." Transactions of the ASABE 55(1): 303-312.
- Chen Y., Zhu H., Ozkan H.E. (2012). "Development of Variable-Rate Sprayer with Laser Scanning Sensor to Synchronize Spray Outputs to Tree Structures." Transactions of the ASABE 55(3): 773-781.

Gu J., Zhu H., Ding W. (2012). "Unimpeded Air Velocity Profiles of Air-Assisted Five-Port Sprayers." *Transactions of the ASABE* 55(5): 1659-1666.

## **Session 3 E**

### **Program**

**Track/Session: Marketing Opportunities/MarketMaker**

**MarketMaker: An Electronic Network that Connects Farmers, Processors, Distributors, Food Retailers and Consumers**

*Ronald Rainey, University of Arkansas, Little Rock, AR; Darlene Knipe and Richard Knipe, University of Illinois Urbana Champaign*

**MarketMaker: An Electronic Network that Connects Farmers, Processors, Distributors, Food Retailers and Consumers**

**Ronald Rainey**

**University of Arkansas**

**Little Rock, AR**

**Darlene Knipe and Richard Knipe**

**University of Illinois Urbana Champaign,**

**Champaign, IL**

### **Background**

MarketMaker was developed as an online marketing resource to give Illinois farmers greater access to regional markets by linking them with processors, retailers, consumers and other food supply chain participants. It is currently one of the most extensive collections of searchable food industry related data in the country, containing over 600,000 profiles of farmers and other food related enterprises in Illinois, Iowa, Georgia, Mississippi, Nebraska, Kentucky, Michigan, Indiana, Ohio, South Carolina, New York, Colorado, Arkansas, Florida, Louisiana, Pennsylvania, Texas, Alabama, Wyoming, and the District of Columbia. All the information can be mapped and queried by the user. Each partner state has their own unique site or portal but all sites access a common database. This allows users to conduct multi-state searches for information. The site was created by a team of University of Illinois Extension researchers with the intention of building an electronic infrastructure that would more easily connect food producing farmers with economically viable new markets and aid in the development of quality driven food supply



chains. The project was initially funded by the Illinois Department of Agriculture, University of Illinois Extension, and the Illinois Council on Food and Agricultural Research (C-FAR).

Figure 1. Site Reflecting Market Maker

### Creating a National Food Marketing Data Base

Taking the single state concept and expanding it into a regional and national model has the potential to significantly grow the economic impact of this marketing resource. A multi-state partnership of land grant institutions and state agricultural agencies has formed and are committing local resources to build this national network of interconnected sites of searchable localized consumer and food industry data. The Iowa MarketMaker site came on-line in early 2006. Since then, sixteen additional states (including Washington DC) have been added. In addition, a national portal for all state sites can be found on the National Ag Marketing Resource Center site ([www.AgMRC.org](http://www.AgMRC.org)).

### Strategy for Building the Electronic Infrastructure

The states participating in the MarketMaker Network share in developing the strategies to grow and improve MarketMaker’s capacity as a food marketing resource. An advisory board made up of regional representatives regularly contributes to the decision making process for growing MarketMaker. Each state creates their own educational outreach program that teaches farmers and entrepreneurs how to use the site and market value added food products.

The National MarketMaker group sustains the platform and manages the data base that is the foundation for all the state sites. New technologies and features are incorporated by the team as needs are identified and resources become available. Since MarketMaker sites can host a wealth of educational information beyond the data that is currently the centerpiece of the site, there is an emerging effort to develop the educational capacity of MarketMaker. The Land Grant Institutions that are currently part of the project bring a powerful reserve of knowledge and expertise in the area food enterprise development and marketing. Allowing each state to feature educational content in areas where they have the greatest expertise gives the user incentive to visit all the MarketMaker sites within the system.

MarketMaker has the potential to create efficiencies in the marketing and distribution of food products enabling small businesses, including farmers, to profitably participate in the food supply chain. It benefits users with easier source verification, the agile development of regional and local food supply chains and expanded choices for consumers. It taps the power of the internet to level the playing field for small businesses and farmers and the capacity of the land grant system to educate new players in the food supply chain about production, marketing practices and food safety.

Traffic and visitors to the site have grown steadily and exponentially since the site was established. Over the past 12 months MarketMaker experienced over 15 million hits. The number of unique visitors for the month of July 2012 exceeds 96,000. In a typical 30 day period MarketMaker users view over 8,500 unique business profiles.

### Funding the MarketMaker Network

Each state is responsible for the funds to build its MarketMaker portal. State targeted marketing and education is also handled by the states. Typically, multiple organizations within each state pool resources to help cover the cost of implementation and outreach. Supplemental funding comes from grants. All new development and national marketing for MarketMaker is the responsibility of the National MarketMaker staff located at the University of Illinois. Funding for new development comes from grants while maintenance costs are covered by annual fees from states. Funders include USDA-NIFA, Ag Marketing Resource Center and the University of Arkansas Ag Sustainability Center. The National MarketMaker URL is



<http://national.marketmaker.uiuc.edu/>



**Fig 2. Site Reflecting Market Maker and State Partners**

**Session 3 G**

**Track/Session: Program Planning and Implementation/  
New and Beginning Farmers Part II**

**Growing Agripreneurs: Educating Beginning Farmers on a University Teaching Farm**

*Maud Powell, Oregon State University Small Farms Program*

## Growing Agripreneurs: Training the Next Generation of Farmers

Maud Powell

Oregon State University Small Farms Program

### Background

**The face of agriculture is changing in Oregon. The average age of Oregon farmers is 57.5 years, the oldest on record. The number of farms in Oregon has declined to a nine-year low. Young people used to learn about farming from growing up on the family farm. Complex social and financial pressures have dramatically changed this relationship.**

**At the same time, specialty crop producers are making a comeback in Oregon. This vibrant sector of our economy has endless potential and opportunity for growth. The average market value of products sold has increased by nearly \$13,000 per farm in Jackson County between 2002 and 2007. Southern Oregon now hosts 10 weekly farmers' markets and 11 Community Supported Agriculture (CSA) programs, up from just three markets and one CSA..**

**Extension faculty from around the state has seen a dramatic increase in the number of people interested in pursuing a career in sustainable agriculture. Despite the demand, however, there is no comprehensive plan to educate and train this new generation of farmers. Quality on-farm training, educational programming and business development support are essential to address this problem and open opportunities for beginning farmers.**

### Program Overview

**The Oregon State University (OSU) Small Farms program has been working to develop comprehensive beginning farmer education for the past five years. The newest program, Growing Agripreneurs is designed for beginning farmers seeking a hands-on, season-long educational experience. The program boasts a low student-teacher ratio and consists of weekly field work as well as classes, skill-building sessions and one-on-one mentoring.**

**Over the course of a season, students are exposed to all aspects of sustainable, small-scale farming including production of annuals, perennials, grains and cover crop. Participants gain extensive field experience working on OSU Extension's 1 acre Teaching Farm, as well as by touring other farming operations. Eleven classes cover both theoretical and practical information and are taught by OSU faculty, experienced farmers and other agricultural professionals. Monthly field walks are conducted to help participants develop critical observation skills, which are crucial to farm planning and management. Skill building workshops are held during these hours on relevant topics such as making propagation media, installing drip tape and trellising. Students have the opportunity to sell at a local farmer's market and participate in harvesting, packing, booth display and sales. Students also learn to pack-out and distribute produce through an on-line market program. Evaluations from the first cohort demonstrate a high degree of satisfaction with the program and a dramatic increase in skills and knowledge.**

### Program Components

## **1. Classes**

**Eleven classes are offered between April and October on various aspects of small-scale production. Classes are taught both at the Extension and on host farms around the Rogue Valley. Curriculum modules developed for the Growing Agripreneurs program will be available through OSU and the Oregon Department of Agriculture for use on other teaching farms. Class topics consist of:**

- **Basic Horticulture**
- **Greenhouses**
- **Soil science**
- **Crop Rotation/Cover Cropping**
- **Irrigation**
- **Entomology/Plant Pathogens**
- **Compost/Weeds**
- **Tractor**
- **Post-harvest handling**
- **Seed Production**
- **Winter Farming**

## **2. Field Work**

**On weeks when classes are not held, participants work alongside a farm mentor at OSU's Franklin Teaching Plot for a minimum of three hours. Activities are seasonally dependent and include all aspects of specialty crop farming including seeding, transplanting, cultivation and harvesting. Field work hours are determined based on the participants' schedules. Hours spent alongside the farm mentor provide ample opportunities for discussions about farming methods and practices, as well as hands-on instruction and feedback.**

## **3. Skill-building Sessions**

**Once a month, farm mentors choose a particular skill to demonstrate and practice with the Growing Agripreneurs cohort. Members of the cohort can request sessions based on their interest and level of skill. Skill-building sessions include, but are not limited to:**

- **Making soil media**
- **Laying out drip irrigation**
- **Seed saving**
- **Incorporating compost and fertilizer into beds**
- **Pruning**
- **Trellising**

- **Post-harvest handling**
- **Weed identification**
- **Cultivation and Hoeing**
- **Sowing cover crops**
- **Basic tractor maintenance**

#### **4. Market Training**

**Participants of the Growing Agripreneurs program also have opportunities to market products grown on the teaching farm. Current venues used for market training are the Jacksonville Sunday Farmers Market and the Rogue Valley Online Market. At the Jacksonville Sunday Farmers Market, participants set up the booth, work on market display, learn about pricing and competition, and practice customer service. The on-line market requires skills in packing and inventory management.**

#### **Impacts**

**Impacts from the first year of the program were impressive. Of five program graduates, three went on to start their own farming operations while the other two secured jobs as farm managers. Pre and post-test results, as well as evaluations indicate a significant increase in knowledge and comprehension of basic sustainable agricultural principles.**

**In 2012, the number of Growing Agripreneur participants doubled. This increase highlights a growing demand for hands-on agricultural education.**

#### **Future Collaborations**

**In 2013, Growing Agripreneurs will team up with Rogue Farm Corps (RFC) Farms Next on-farm internship program. Rogue Farm Corps is a non-profit organization that works to improve the quality of farm internships in Southern Oregon. The two programs currently emphasize different aspects of agricultural education: OSU focuses on academic, classroom-based learning, while RFC highlights various farm operations and their practices.**

**Also in 2013, OSU Small Farms faculty will work with the Oregon Department of Agriculture to develop a toolkit and teaching manual for other Extension and Research stations interested in hosting similar teaching farms. The toolkit will include sample outreach material, curriculum, tool and equipment lists and farm plans.**

**The following comments highlight other qualities of the workshop series:**

**“The Small Farms - Agripreneurs Program gave me the confidence, skills and guidance I needed to start farming on my own. I was able to take the information I learned from the classes and field work and apply it directly and immediately to my own farm. It was an invaluable experience.”**

**“The weekly mentorship with the farm manager proved to be an incredible resource in helping me with all of the questions, concerns and ideas for my own farm.”**

#### **Reference:**

**USDA. 2007. Census of Agriculture.**

## **Session 3 H**

**Track/Session: Research and Extension Priorities/Specialized Services and Technologies**

**Bundling Elements of Federal Support Programs for Underserved Small Farming Communities and Rural Microbusinesses/Enterprises in Selected Southern States: A North-South Institute, Inc. Experience**

*Samuel W. Scott, North-South Institute, Inc,*

**Bundling Elements of Federal Support Programs to Underserved Small Farmers, Cooperatives, Rural Small Businesses and Micro Businesses in Selected Southern States:**

**Dr. Samuel Scott**

**North-South Institute, Davie, FL**

There are several practical and innovative ways in accessing and delivering Federal Programs to guarantee the development of success Small Family Farmers, Rural Cooperatives Rural Small Businesses and Micro Businesses. In the USDA there are over 21 Key Federal programs that can be of benefit to underserved Small Farming Communities, Rural Small Businesses, Micro Businesses in Southern States. These are shown summarized in the following table:

<b>USDA Agencies</b>	<b>Specific Programs for Small farmers</b>
<b>Agricultural Marketing Services (1)</b>	<b>Farmers Market Promotional Program - Direct marketing through farmers market, roadsides stands and CSA</b>
<b>Farm Service Agencies (4)</b>	<b>Non-Insured Crop Assistance Program (NAP)</b>
	<b>Loan (Microloans) Programs for purchase and operations</b>
	<b>Youth and Beginning farmer Loan Program</b>
	<b>Supplemental Revenue Assistance Program</b>
<b>Natural Resource Conservation Service (2)</b>	<b>EQUIP Program specifically micro and drip irrigation, cross fencing for livestock</b>
	<b>Hoop House and High Tunnel and Season extension Green House Program</b>
<b>National Institute of Food and Agriculture (5)</b>	<b>2501 – Outreach for Small and Disadvantaged Small Farmers and Ranchers</b>
	<b>Organic Farming</b>
	<b>Specialty Crops Research Program</b>
	<b>Beginning Farmer Program</b>
	<b>Food Safety – GHP/GAP and BMP</b>
<b>Rural Development (7)</b>	<b>Rural Microenterprise Assistance Program</b>
	<b>Value Added Assistant Grant Program</b>
	<b>Rural Business Enterprise/Commercial Kitchen</b>

	<b>Community Facilities</b>
	<b>Small Producer Grant Assistance Program</b>
	<b>Biomass Crop Assistant Program</b>
	<b>Business and Industry Program</b>
<b>Risk Management (2)</b>	<b>Outreach Partnerships</b>
	<b>Education and Small Session Workshops</b>

The keys to delivery and efficacy are: (a) collaborative partnerships are required between beneficiaries, local CBOs, universities, and the county/state agencies responsible for the implementation of these programs and (b) targeted beneficiaries receive a basket of services and resources that include: technical assistance; training and access to financial resources to implement the requisite changes beneficiaries are taught. These must be identified with the client beneficiaries before intervention. However, there are some structural issues that must be addressed to ensure program success. These are as follows:

- implementation of these federal programs can be highly “projectized” which allows for fragmentation in delivery of resources and duplication,
- interagency competitiveness between CBO’s and Academics Institutions that reduces the effectiveness of partners that should collaborate to serve these intended beneficiaries ,
- targeted beneficiaries capacity, knowledge, physical capital, and work program follow-through can be low and inconsistent,
- volatility and indifference in County Offices services as reflected in agent capacity, attitude, and willingness to work with targeted beneficiaries, and
- sluggishness of CBOs and Universities cooperation as reflected in agent capacity, resource endowment, ability to forge relationships, creativity in building programs, and bureaucratic rigidities.

However there are pockets of success stories and methodologies used in overcoming these challenges as seen in the case of: (a) Willing and Purpose Driven Small Farmers in Florida ad Border Counties of Alabama and Georgia; and (b) Small Farmer Group that saw collaboration in a Cooperative Structure as their “Best” way for growth and survival in Florida. These were achievable through partnership and cooperation in addressing these issues.

**Issue 1. The implementation of these federal programs can be highly “projectized”** which allows for fragmentation in delivery. Each project has distinct guidelines that cause the implementation to be projectized. Cross cutting themes may not be able to be easily explored. The result is that different sets of training, technical assistance and outreach must be done on the same site with the same farmers. This cause producers tending to show training, technical assistance and outreach fatigue after the first set of interventions.

**Issue 2: Interagency Competiveness between CBO's and Academics Institutions.** Turfs have been developed over the years with each group trying to protect their territory, resulting in brinkmanship, marble counting and gatekeeping. As well as, ossification of university programs not able to adjust quickly to major changes that these production entities and communities are facing.

**Issue 3. Targeted Beneficiaries - capacity, knowledge, physical capital, and work program follow-through.** While beneficiaries show knowledge- gap treadmill fatigue they are reluctant to treat their operations as businesses, for example the lack of keeping basic records. In some cases, while beneficiaries are willing they are can literacy and language challenged, and in so doing impose self-isolation resulting in non-participation in programs that could help them. For those who have tried there are road blocks in accessing capital in a timely manner and in amounts that are required for financing business decisions. In some instance participants are reluctant to follow-through on activities that ensure profitability of the enterprises.

**Issue 4. County Offices - agent capacity, attitude, and willingness to work with targeted beneficiaries.** In some offices there is the lack of capacity to understand the clientele they are to be working with on small farm issues. In some, there are blatant refusals to make adjustments in reaching out to work with these beneficiaries. This is reflected in not willing to change the status quo or challenge the demonstrative guidelines that appear to be only applicable for farmers growing program commodities. In other offices there is the use administrative guideline trickery to confuses the beneficiaries and instill an environment that results in none or low participation in the programs.

**Issue 5. CBOs and Universities - agent capacity, resource endowment, ability to forge relationships, creativity in building programs.** There are several CBOs not having the resources to hire and retain the requisite subject matter specialists and personnel. Coupled with Universities agents working within their comfort level and in some cases effective Agents are not able to work across counties or state lines. While some technicians are willing to work together from both groups, Universities' bureaucracies are slow in allowing for these relationships to be developed. This is further exacerbated by the overall lack of creativity to develop programs that are relevant for these client groups.

Notwithstanding the above there are some partnerships and collaborations that have been able to bundle various elements of Federal programs and approach the clients in somewhat of a surgical team in identifying and solving challenges that when overcome resulting in successful small farmers. The process entails in mitigating the abovementioned five issues include:

- Development of Working Relationships using MOUs to foster partnership between CBOs and the Universities
- Reaching out of County Agents to officers within the CBOs that can work directly with the producers in addressing their areas of needs - Success have been seen with FSA, NRCS and RD offices in some counties in some States
- Building strong partnerships with CBOs from other States working with similar groups of clients
- Rigorous scouting of the various programs and developed technical assistance, training and outreach packages where solutions can be bundled in the delivery to beneficiaries



- Beneficiary developed the discipline to transform their operations in to cash flow businesses through business planning, enterprise diversification, direct marketing and sound enterprise reinvestment.
- Partnerships developed where there is the linking of technical assistance and training to access to resources provided in Federal programs

The successful outcomes have been evaluated by using the following matrix as showing the result indicators below:

<b>Key Result Indicators</b>	<b>Pre-Intervention</b>	<b>Post- Intervention</b>
<b>1. Improvement in organization and Management</b> as measured by Farm and Business Planning, Tax Planning and Use of Record Keeping	No systems or planning No Farm record No Use of Schedule F in Tax Filing	Farm Plans, Marketing Plan, Risk Management Plan, Business Plans, Financial Plans
<b>2. Cash Flow Management</b> as measured by Management of Cash Inflows and Outflows, Loan Management and Farm Reinvestment	No cash reserves or set aside for investment Always cash strapped	Cash to cover major cost of production drives Use of Loan for expansion and participation in revolving micro loan
<b>3. Increase in the level of Assets acquired</b> through lease, rental or purchase	No land for Farming Less than 20 acres	Land Base expand to over 50 acres of seasonal production by leasing municipal and private lands
<b>4. Improvement in marketing Systems, Transportation and Infrastructure</b>	Low Volumes No Organize Market Self-Competition	Increased volumes from mono culture crops to diverse packaged to supply the markets Development of packing stations
<b>5. Increase in Sales, Gross Revenue and Overall Farm Incomes</b>	Less than 4 figure sales/income per year	Sales and Income increase to 5 figures annually

## Session 3 I

### Track/Session: Marketing Opportunities/Value Added Products

#### Local Meats and Local Meat Networks

*Lauren Gwin, Oregon State University, Corvallis, OR*

## **Local Meats and Local Meat Networks**

**Lauren Gwin**

**Oregon State University, Corvallis, OR**

### **Introduction**

Farmers and ranchers aiming to sell into local and other niche markets need information about farm-level production but also post-farmgate steps, including processing, distribution, and marketing. They also need to understand the economics and regulatory requirements related to each of these. Niche markets may be a way to manage risk, through market diversification, but they also come with their own risks: production differences, limited understanding of post-farmgate steps, assumption of more roles within those steps, and increased capital requirements to hold livestock and inventory. These challenges remain largely unaddressed by traditional Extension programming.

From February 2011 to February 2012, we provided education to meet this challenge in multiple formats to approximately 2251 experienced and new livestock producers in Oregon. The project provided valuable, practical information; facilitated peer-to-peer learning and new collaborations among Oregon's niche meat producer-marketers; trained trainers to extend this knowledge back into rural communities; and solidified relationships between state agencies and Oregon State University. The project succeeded because we were flexible in what and how we delivered, meeting evolving local and regional needs and an evolving regulatory climate with new market opportunities.

### **Three Phases**

The project began and ended with short courses (“meat tracks”) at the 2011 and 2012 Oregon State University (OSU) Small Farms Conferences. At the 2011 Conference, 130 beginning and/or small-scale livestock producers attended three sessions on niche production, processing, and marketing to learn about opportunities and risks of these markets, and functional and regulatory aspects of associated supply chains. Twenty-eight attended a half-day, limited enrollment carcass breakdown workshop.

Over the year, between the two conferences, we offered small group workshops and one-on-one assistance, based on regional and emerging needs and opportunities. We covered requirements and expectations around production, supply chains, market channels, business management tools, regulatory requirements, food safety risks and strategies, and other issues associated with local, niche meat markets. Events included:

- Two in-depth, small group workshops: “Farmers, Chefs, and Local Charcuterie,” and “Multi-Species, Multi-Market Channel” (34 attendees);
- Niche marketing presentations, one with a panel of marketers for peer-to-peer learning, at two livestock producer events (60 attendees);
- Focused guidance and technical assistance to 30 producers.

### **Local Charcuterie**

Responding to local demand, this workshop met the needs of livestock producers in Oregon's North Coast region, an underserved audience in Extension education around small farms and niche markets. As charcuterie products increase in popularity, especially using locally raised meats, it is critical for both farmers and chefs to understand not only the local, state, and federal regulations, but also the food safety risks associated with these products and effective interventions. The main draw was a product demonstration by a Portland-based charcuterie manufacturer, Olympic Provisions.

State and county regulators, who gave presentations also benefited from the chance to collaborate with each other and OSU on a complex, confusing, and evolving regulatory issue.

### **Multi-Species, Multi-Market Channel**

We recruited a well-established niche livestock products marketer from the San Francisco Bay Area, David Evans of Marin Sun Farms, to speak with experienced Oregon producer-marketers about advanced marketing tools and topics including yield tests and pricing formulas; trust, risks, and responsibilities in co-supplier relationships and contracts; inventory control and management systems; market channel trade-offs; and the financial and regulatory requirements of retail butcher shops. Participants shared their experiences, aspirations, what worked and what had not and evaluated risk of various marketing channels and supply chains. Session content was published as an OSU Small Farms Program technical report.

This session also responded to demand from producers for advanced-level topics and interaction. Over the course of this project, it became clear that while we need to continue providing basic "101" level information about niche marketing to beginning farmers, we can also play a key role in structuring and facilitating peer-to-peer learning among advanced, experienced producer-marketers. Our second such session, at the 2012 OSU Small Farms Conference, focused on yield tests, product costing, co-supplier relationships, and inventory management and was well attended (40+).

### **One-on-One Assistance**

Some producers, typically those actively marketing meats, sought our technical advice and guidance on an ongoing basis as they developed their projects. For example, we:

- Organized a conversation about infrastructure needs and potential collaboration with a regional distributor and two producer-marketers, all panelists at the first Short Course, pursuing similar, parallel plans;
- Assisted an experienced grass-fed beef producer with (a) strategizing how to improve the transparency and stability of her supply chain and (b) writing a successful USDA Rural Development Value Added Producer Grant to move her strategy ahead;
- Helped two experienced beef and poultry producer-marketers analyze the risks and opportunities around options, including a partnership with OSU, to operate their own retail cutting facility;
- Assisted a beginning poultry farmer by identifying regulations (and agencies) relevant to his current and planned operation; helping him evaluate supply chain partners and estimate costs; and gathering national data from other farmers about technical aspects of his plan;
- Identified scale-appropriate inventory management systems for a multi-species farmer-marketer and helped her strategize options and costs of USDA-inspected processing options.

The final phase of the project was the 2012 Conference Meat Track, which included a pair of sessions on multi-species, multi-channel niche meat marketing, one basic and one advanced (described above). A third session outlined new state regulations for small-scale poultry processing. In a full-day hands-on workshop, we trained producers on those new regulations along with best practices for open-air processing.

Throughout all three phases of the project, we recruited experienced producers as speakers, sharing expertise and lessons learned.

## **Outcomes**

Event evaluations showed increased knowledge on every topic and that participants would apply what they learned to their operations. As one participant in the carcass breakdown workshop said, “I have been a rancher my entire life and have never learned as much about my product as you provided in this experience.” Participants reported making significant changes, with new business approaches, marketing plans, and processing partnerships.

Twelve producers reported changing their marketing strategies as a result of our project; many others have likely made changes not reported to us. We expect that many participants, especially those with little or no niche market experience, have chosen not to niche market due to (a) costs and risks and (b) current high commodity market prices for conventionally raised livestock. “Opting out” is not a negative outcome for most producers, who may otherwise take on added risks without increasing profitability.

Local chefs who attended the charcuterie workshop are working on incorporating the products they learned about into their menus. For example, one chef is now doing in-house charcuterie and trying to connect with local meat producers who can raise enough pigs to meet his restaurant’s needs. This represents a significant market opportunity for local producers.

All participants in “Multi-Species, Multi-Market Channel” have reported that they learned a great deal about how to develop and manage a system of interdependent production, marketing, processing, and distribution systems. Each took away several “lessons learned” that they want to apply to their own operations. As one reported, “I found this call the single most helpful thing I have done for my business this year. Having the opportunity to speak with a successful producer and glean insight from his mistakes will undoubtedly save me from many of my own. His perspective about which aspects of his business are most profitable will take much of the guesswork out of our expansion, and help us focus on areas which will likely be most profitable.”

In addition, producers and others who interacted during the overall project continue to share information and expertise about marketing local meat and poultry. As one participant noted about the 2011 meat short course, “what really impressed me was how many people stayed and talked,” compared with other sessions. “The livestock people may be more eager to learn from each other.” This networking is a hallmark of the OSU Small Farms Program. We do not claim that this project, or the Program, is solely responsible for these collaborations but that we contribute information, technical expertise, a forum, and facilitation. Examples:

- Two project participants are now collaborating on a new regional distribution business for their livestock products and continue to call on us for information and advice;
- Participants are now teachers: poultry producers who learned about the new regulations and market opportunity at our conference have helped us teach a hands-on poultry workshop in their region;

- Building on the mutual trust and credibility established through this project, the state agriculture department's Food Safety Division partners with us on outreach and education, through workshops and publications;
- Non-profit organizations based in remote areas of rural Oregon have attended our conferences and workshops and have brought the information and materials back to their localities.

### **What Worked for Participants**

From evaluations and discussions with participants, we learned that in addition to the useful and practical information they learned, they also valued the following:

- Opportunities for networking and peer-to-peer learning;
- The choice of expert panel members who networked with participants and shared candidly from their personal experiences;
- Workshop topics designed to meet regional needs;
- Two levels of sessions/workshops: "101" level for beginner niche marketers and the "301" level for advanced producer-marketers;
- Option of one-on-one assistance on a wide range of niche meat marketing information topics, rather than the originally planned small group sessions;
- Flexibility to assist producers with new niche market opportunities as they emerged.

### **Lessons learned about project design and implementation**

Our most important lesson learned was that project plans may have to change when conditions change. Goals are more important than tactics.

We originally structured the project to begin with the 2011 Short Course and then follow up with self-selected producers in several day-long small group sessions around Oregon, where producers would brainstorm opportunities with each other and develop their own, simple niche meat marketing plans. Yet while the Short Course exceeded expectations, very few people signed up for the small group sessions, perhaps in part because the Short Course was so action-packed that future sessions were not "front of mind." In addition, producers, while actively engaged in the content we provided and in evaluating their options, appeared reluctant to spend time preparing written action plans as we had originally projected. Most sort things out mentally and start acting, adjusting their approaches as they go.

We responded by reaching out to four regional leaders around Oregon to learn their perceptions of current needs and conditions, and we redesigned the project accordingly. We also recognized that one-on-one assistance would be more useful for broadly dispersed producers. Multiple producers contacted us over the course of the project with specific requests for information and advice on how to change, improve, or fix elements of their existing operations.

In conclusion, this project has established the OSU Small Farms Program as a valuable source of practical education related to local, niche meat marketing, as well as a hub for Oregon's livestock producers to network with and learn from each other about this topic.

We thank the Western Center for Risk Management Education and Oregon State University for providing funding for the project.

#### Notes

1. This figure is an estimate; it does not include 2012 conference attendees, to avoid counting repeat participants twice.

### **Using a Transportation Alliance to 'Buy-Local' and 'Sell-Local' by Small Environmental and Food Horticultural Farms**

*Forrest Stegelin, University of Georgia, Athens, GA*

# **Using a Transportation Alliance to ‘Buy-Local’ and ‘Sell-Local’ by Small Environmental and Food Horticultural Farms**

**Forrest Stegelin,  
University of Georgia, Athens, GA**

## **Background**

During the past 5 years, economic and social and climatic factors have negatively impacted the food and environmental horticulture crops industry in Georgia. The prolonged drought, the global and domestic economic recession, the instability of oil prices, and the increases in production input costs have forced these industries to become more efficient in both production and marketing and distribution. The trend of rising costs has been more persistent in transportation and logistics. Transportation is becoming the determining factor of success for most fresh produce and floriculture/environmental horticultural operations, regardless of size. How, when, and with whom growers do their shipping determines how sustainable, efficient, productive, and profitable an operation becomes. With the surge in interest for “buying local” comes also the need to address “selling local,” as producers becoming expected to deliver their goods to “local” retailers. The term “local” often involves transporting produce or plants 250 – 300 miles one way. Deliveries of inputs are often being made from the same source to neighboring operations and/or growers are making deliveries to common buyers at about the same time over common routings, duplicating the transportation costs (ownership and variable expenses) for the small-to medium-sized operations. Industry participants share clients, routes, and origins; yet, each producer has an independent transportation system. “The remedy for the medium- and small-sized carrier businesses is to establish coalitions in order to extend their resource portfolio and reinforce their market position” (Krajewska and Kopfer, 2006).

## **Problem, Objectives, and Methodology**

Most Georgia produce and green industry operations own their own box or container trucks and tow-trailers, owning multiple units of various sizes and capacities so that a match can occur between order size and appropriate vehicle for delivery. Among the factors that affect the expansion of horticultural crops (food or ornamental) operations, production, marketing, agricultural labor, and transportation are considered the most relevant (Hodges and Haydu, 2005). Ornamental plants nurseries ranked transportation as an important factor of concern for expansion of their markets, ranking transportation above debt capital, equity capital, and marketing, but below labor and production (Brooker et al., 2005). In the agricultural sector, the importance of transportation costs is heightened as evidenced by the statement that transportation accounts for over ten-percent of the wholesale value of total farm shipments (Stegelin, 2009). Logistic cooperation is an important strategic alternative to reduce costs and increase efficiency in the agricultural sector.

The objective of this project is determining if a transportation alliance through horizontal cooperation and routing junction or logistic software would reduce shipping costs and increase distribution efficiency among fresh produce suppliers in Georgia who are “selling local.” The methodology includes conducting meetings with prospective collaborators to explain the reasons and benefits for participating in the evaluation, explaining what an alliance is (versus a cooperative), and identifying the data needed as input to develop a simple unit cost allocation model that is adaptable and useable with the GIS

software ArcLogistics 9.3. The last step is to evaluate and interpret the results to build a sensitivity analysis.

Once the order sharing routings were developed, three alliances were considered – a north, a south, and a central location cluster – which represented most of the production among the small- to medium-sized operations. An attempt was made to determine the optimal number of orders per shipping cycle, given the three location clusters (alliances), with the decision to assign 50, 100, and 150 orders per shipping cycle due to the variability and inconsistency in current deliveries. Time windows were also evaluated with respect to the delivery efficiency (time spent unloading at each delivery destination), which were also grouped as 30-, 60-, and 90-minute stops. With respect to each of the alliances, a central depot location (central to the producing operations in that alliance) and a major thoroughfare location were also evaluated.

Although the study seemed to have buy-in from the fruit and vegetable growers, concerns among the cooperators and participating producers arose with respect to the survey. Examples of these issues included: “What’s in it for me?”; a reluctance to provide logistics, marketing and sales (volumes, product lists, delivery dates and sites, etc.) information; additional concerns about what an alliance was and entailed for shipper involvement; survey design; adequate sample size; format and availability of data needed to run the software; a lack of commonalities among the growers (facilities, vehicles, customers and their locations, product specifications, shipping containers, delivery dates and times, driver efficiency, etc.); and the managerial relevance of using averages in conducting the sensitivity analysis.

## **Results**

This particular study arose from a MS horticulture student’s thesis (Mantilla, 2010) which focused on using a transportation alliance solely by the ornamental and greenhouse crops industry in Georgia. Because many of those participants communicated their involvement in the student’s research to their neighbors who were fresh fruit or vegetable growers sharing many of the same logistical constraints and opportunities, and who were obligated to make deliveries of their fresh produce to grocers and other marketers in communities many miles away from the farm, a request was made to assist the fresh fruit and vegetable producers by the Georgia fruit and vegetable grower trade associations and organizations. The MS thesis on the ornamental industry served as a check for comparison, to validate the results obtained for the produce industry.

Eighty-percent of the respondents to the fresh produce inquiries stated that transportation and delivery costs had increased over the prior year, at an average rate of 21-percent among the respondents, and that transportation costs now account for over 10-percent of their total cost of production and marketing. The net results from having evaluated utilizing transportation alliances among Georgia’s small- and medium-sized fruit and vegetable producers were lower in savings than reported for the environmental horticulture crops producers, although both groups’ ownership and overhead costs were year-round. The greenhouse and ornamental plants producers are generating more inventory turns and selling (and shipping) plant materials at least 9 or 10 months of the year, whereas the produce growers are shipping primarily during the summer and early fall (production between last frost and first frost in a calendar year).

The net results for the three transportation alliances were:



- ✓ Average total cost savings to the participating operators were 7-9 percent;
- ✓ Average total miles driven savings were 8 percent;
- ✓ Average numbers of trucks owned savings were 18 percent;
- ✓ Average hours driving time savings were 12 -15 percent; and
- ✓ Average CO<sub>2</sub> savings (reduced carbon footprint) were 11 percent.

Figures and Maps on Following Pages

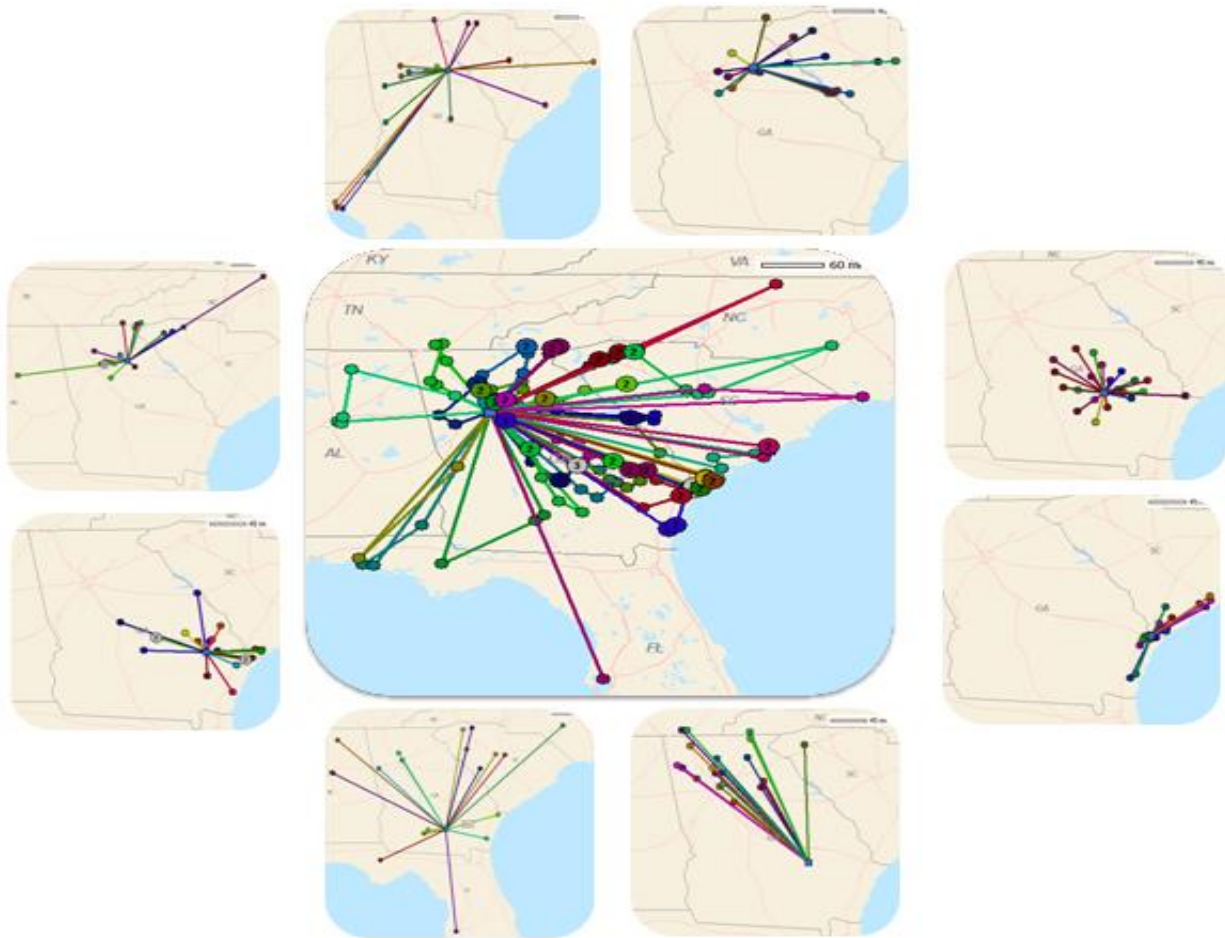

Figure 1. Order Sharing Routing Maps.

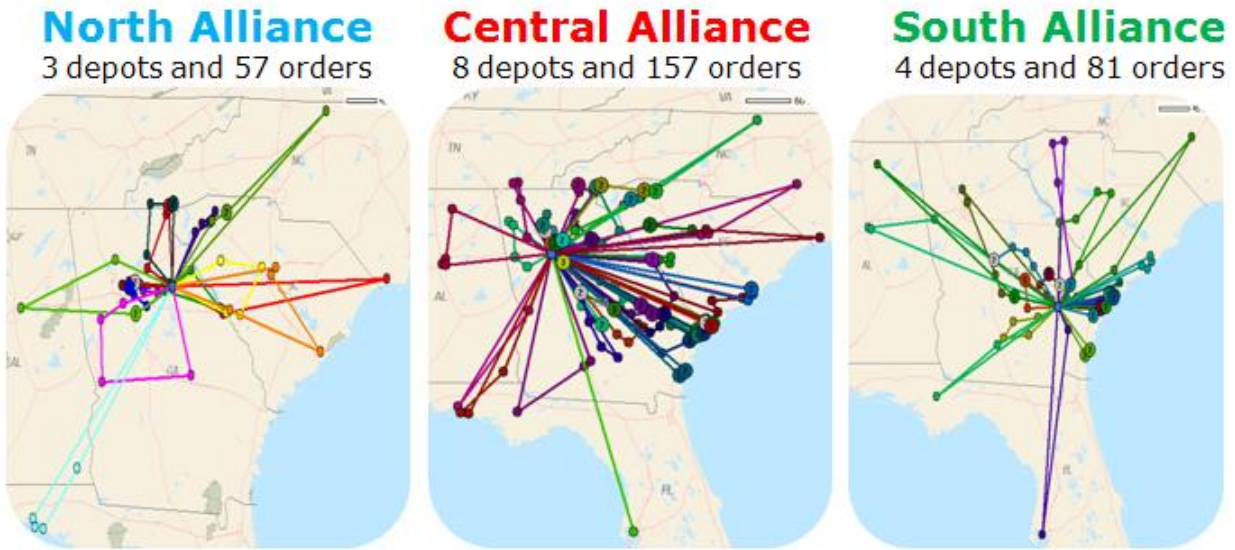

Figure 2. Location Clusters Routing Maps.

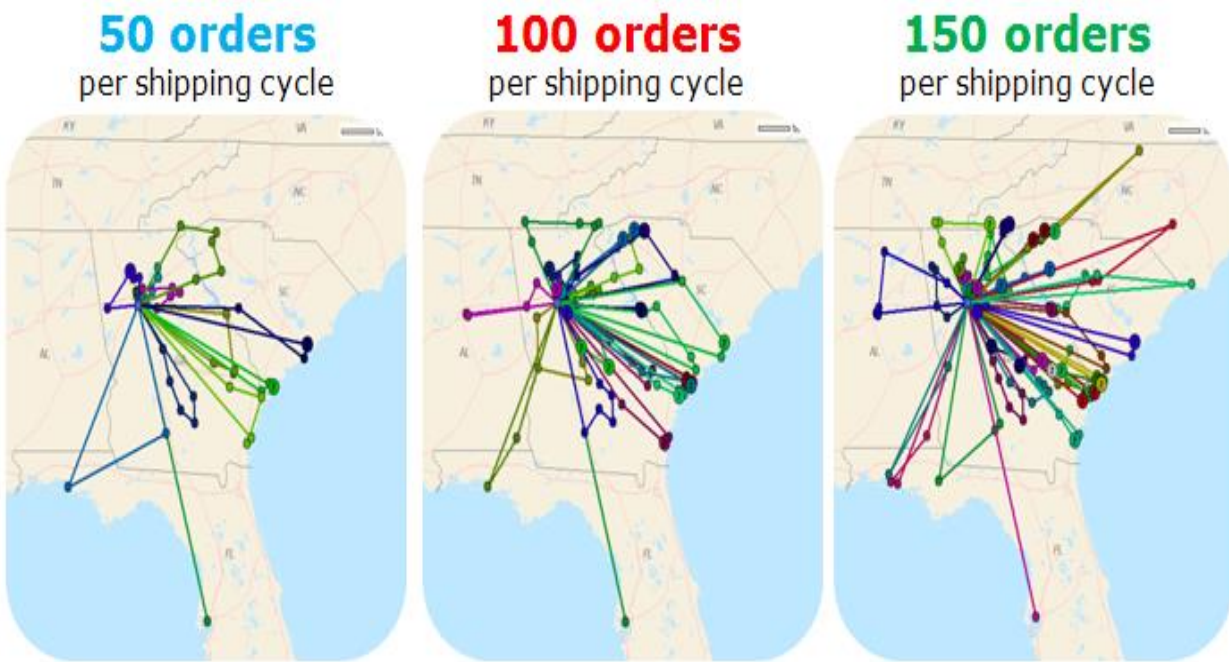

Figure 3. Optimal Numbers of Orders Routing Maps.

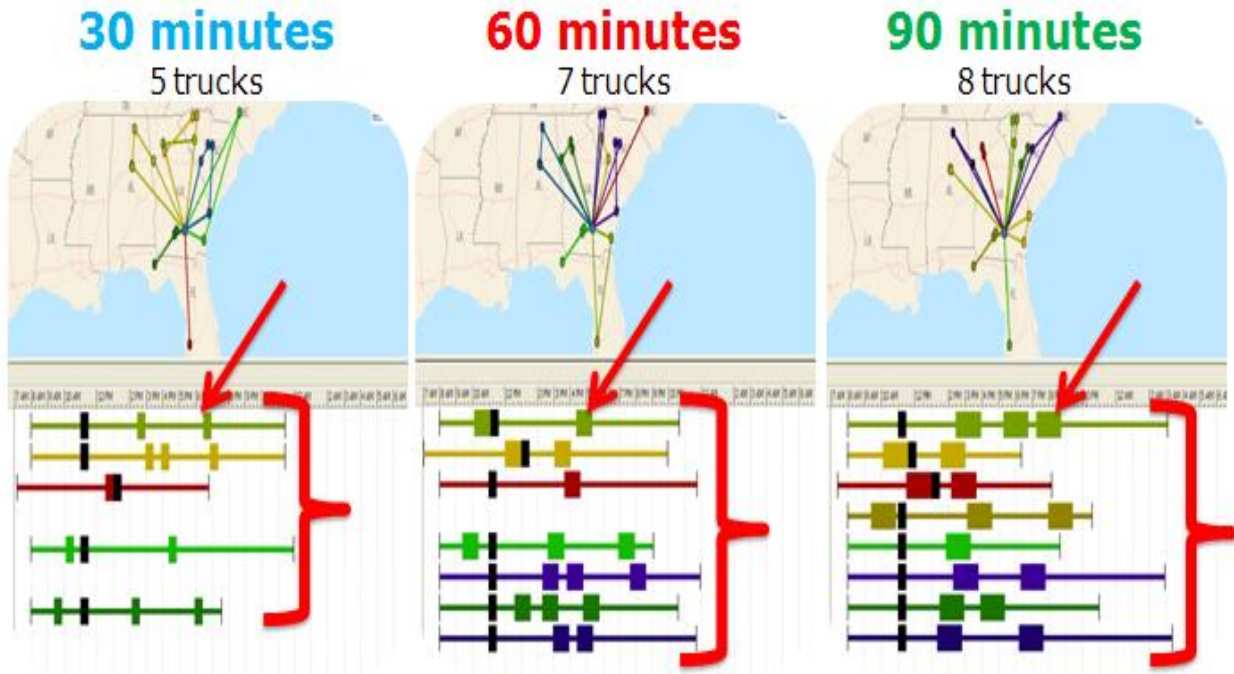

Figure 4. Time Windows Routing Maps.

## Session 3 J

**Track/Session: Marketing Opportunities/Value Added Products**

### **EFFECTIVE MARKETING STRATEGIES FOR FRESH PRODUCE AND VALUE ADDED PRODUCTS**

*Magid A. Dagher, Elizabeth B. Myles, and Nicole Bell, Alcorn State University, Alcorn State, MS*

### **EFFECTIVE MARKETING STRATEGIES FOR FRESH PRODUCE AND VALUE ADDED PRODUCTS**

**Magid A. Dagher, Elizabeth B. Myles, and Nicole Bell,  
Alcorn State University, Alcorn State, MS**

#### **Introduction**

A market is a place or environment in which producers and consumers meet or interact to negotiate the terms of trade, followed by the transfer of ownership of the product to the consumer and cash to the producer. In a nutshell, both the producer and the consumer influence the level of prices. They do so in a free market where the forces of demand and supply work to determine prices that will entice the producer to sell and the consumer to buy.

It is important for the producer to understand the fundamentals of how markets are aligned. This knowledge positions the producer advantageously to exploit the opportunities available to him or her. The fundamentals are embedded in the laws of demand and supply. Understanding the key factors that influence demand and supply enhances the producer's knowledge so that he designs the strategy that will yield the best return.

Marketing activities are many, and may be complex and require resources, both physical and human, that are costly and, therefore, should be planned and implemented efficiently. The more efficient the marketing operation, the more competitive is the marketer or supplier. Marketing efficiency is achieved by cutting cost per unit of product to its lowest level. In fact, if all costs of production and marketing can be kept at their lowest levels, then the producer stands an excellent chance of achieving the highest profit level possible.

Alternatively, if his operation is not profitable, then he minimizes his loss. Most primary agricultural products are sold in a market environment characterized by pure competition. In this type of environment, there are many producers supplying the same product and there are also many consumers buying the same product. Prices, then, tend to be close to the true cost of production and marketing activities. Profit margins tend to be low. Of course, covering all costs is also desirable, even if the net income or profit is zero. Marketing in its simplest form is about building and maintaining relationships. Most people prefer to do business with people they know.

Effective marketing is essential for profitable small-scale farming and agribusiness operations and lies at the core of long-term enterprise competitiveness and viability. Regardless of the enterprise type, small farmers typically invest more time and effort in production than in marketing. As a result, they usually do not reap the potential benefits from their enterprises since marketing is the revenue generating apparatus or life-line for any enterprise. Strong demand usually translates into higher prices, farm incomes and profits.

Marketing involves several physical and coordinating functions: assembly; sorting, grading, and packing; transportation; storage; processing; wholesaling; retailing; and negotiating terms of trade -- i.e., price, quality, quantity, time and place of delivery, and assumption of marketing risks. Before a producer plants crops or invests in a livestock operation, he should ascertain the strength of demand for his product. Again, marketing of agricultural products is essential for small farm viability.

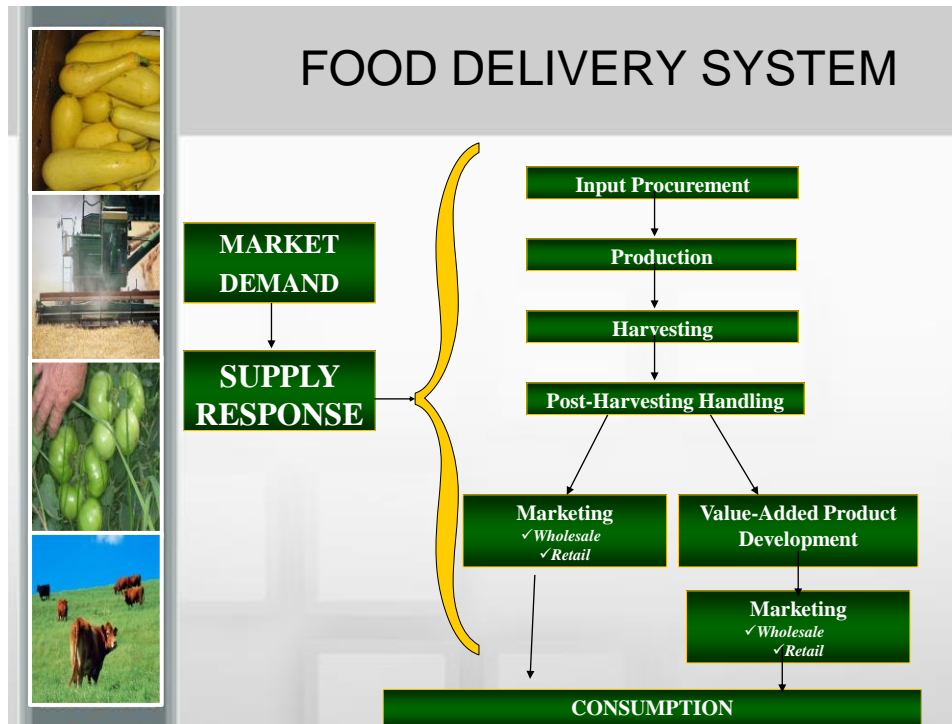

**Figure 1. Food Delivery System**

**Source. Mississippi Small farm Development Center, Alcorn State University**

Figure 1 depicts a common construct of this system and its key components. It begins with identifying demand for a product that one decides to produce. Then, the farmer procures the relevant resources required to produce the product. Next, he combines the resources by applying processes that have yielded consistently good results over time in the production of the crop. When the crop is ripe or ready, harvesting occurs, employing proper harvesting methods by hand or mechanical. Post-harvest handling then follows and typically involves gathering, transporting, storing, washing, sorting, grading, packing and shipping. The primary product enters either the wholesale or retail market. Of course, final sale occurs at the retail level where consumers purchase the product for consumption. If the primary product was value-enhanced through processing, then the processed products would flow to the consumer through the wholesale and retail levels. How well does the producer perform in this system? Source: Mississippi Small Farm Development Center, Alcorn State University

**Value-Added**

Production can be an effective strategy to increase farm income. Adding value means employing product enhancing and processing methods, specialized ingredients or novel packaging to improve the nutrition, sensory characteristics, shelf life and convenience of food products.

The value of farm products can be increased in numerous ways: by cleaning and cooling, packaging, processing, distributing, cooking, combining, culturing, grinding, hulling, extracting, drying, smoking, labeling, or packaging.

Capturing value usually means capturing some of the value added by processing and marketing. For example, the producer's share of the food dollar has seen a steady decline since 1900. The approximate producer's share of the food dollar was 19 cents. The largest share of the dollar is spent on labor costs.



Source: USDA ERS, 2011

Today's food consumers want taste, nutrition, freshness, variety, and convenience. Ethnic populations are growing and niche markets are becoming available. By engaging in value added agriculture, farmers are expecting to increase their net farm profits that would otherwise go to the middlemen in the food chain. The value-added concept often integrates branding and product differentiation and, thus, transforms growers from 'price takers' to 'price makers'.

Value added production requires sound marketing savvy. Getting a new product into the highly competitive retail market is very difficult. There are important considerations before value-added production: market research, business structure, business plan, liability, regulations, technology, food safety, packaging materials, labeling rules, and trade names, patents, copyrights. USDA estimates that at least two out of every three new food products introduced into the market fail due to lack of customer appeal. Only one in five new businesses succeeds for more than 5 years. Failure to do market research and the lack of a sound business plan are leading causes for failure.

Producers should determine the most effective marketing channel for their value-added products: broker, distributor, wholesaler, retailer, consignment, and/or direct-to-consumer. A broker acts as an independent sales person whose responsibility lies in promoting and selling products and relaying the orders to the producer. The services of a food broker are usually retained by a commission fee. When working with a broker, the producer loses some control over the business and/or products. It is important to understand that brokers do not get paid unless they sell the products. Therefore, it is in the broker's best interest to negotiate with retailers to get them to purchase a product. This negotiation may take the form of discounted prices, free items and product take-back or trade-out if products are difficult to sell.

Distributors are different from brokers in that distributors are typically responsible for warehousing, delivering, taking orders and invoicing, and are not primarily responsible for the actual selling and promotion of products. Food producers must often take significant initiative to promote and market their products to retailers and other potential purchasers who will in turn purchase the products from the distributor. It is important to remember that, while a distributor provides many essential services involved in channeling food products from the production to the retail stages, the food producer often gives up some control of the product because the producer cannot ensure the quality or appearance of each product that leaves the distributor's warehouse.

The term wholesale means that retail store buyers purchase the products from the producer – usually in bulk – with the intent to resell the products to the consumer. Wholesale purchases are usually made at a price lower than the retail price. Generally, a wholesale price is 50 percent less than the retail price. This discount is due to the fact that the retailer is expected to add value to the product before it is purchased. The product's retail price includes things such as the cost of advertising and representing it to customers. It also covers many other hidden services, such as a return policy, an 800 number, electronic communication and business-level recourse in the case of fraudulent activity. Many producers decide to use a combination of wholesale and retail sales to sell products.

Selling a value-added product through consignment is a way to test the retail market with the product normally offered for sale at no cost or obligation until sale is made. However, selling the products through this marketing channel is risky because of uncertain cash flow. In direct-to-consumer, the consumer is one who consumes/acquires goods or services for personal use or ownership rather than for resale. The producer has a personal interaction with consumers. The producer is the product-maker, sales person and delivery person. This type of marketing channel can be done through selling at farmers markets, internet, and catalog. With farmers markets, most consumers are looking for an experience. The consumer usually is seeking fresh produce along with a direct link to where their food is produced. The internet allows consumers to shop at home or at work. Online shopping is growing rapidly, and spending in this market is increasing. The catalog allows the consumer to know all about the product before purchasing, such as the cost, origin and other specifications of the product.

### **Tips for Producers in Developing Value-Added Markets**

Identify a niche and the type of market to fill that niche. Determine the consumers' wants and then develop a product (and package) that satisfies those wants. Many consumers in today's marketplace have "special" needs and wants. Also, identify alternative markets. Do not place all your eggs in one basket. Conduct market research and investigate and assemble existing information pertaining to a particular market. Analyzing the market includes the interpretation and application of all the marketing information that is obtained. Market development is essential in value-added production for packaging, distributing, pricing, advertising, promoting and persuading consumers to purchase the product.

Value-added production can be a profitable business venture with careful planning and research. Develop a pricing strategy where the price is high enough to cover costs and generate a profit, yet low enough to

attract consumers. Know the cost of production of value-added product and determine the per-unit price needed to break even on various levels. Finally, keep production and marketing costs as low as possible since agricultural and food markets are usually competitive.

## **References**

<http://www.fao.org/docrep/004/w3240e/W3240E09.htm>

<https://utextension.tennessee.edu/publications/Documents/PB1699.pdf>

[http://www.ers.usda.gov/media/320335/aer825\\_1\\_.pdf](http://www.ers.usda.gov/media/320335/aer825_1_.pdf)

<http://ir.library.oregonstate.edu/xmlui/bitstream/handle/1957/20671/pnw241-e.pdf>

## **Session 3 K**

**Track/Session: Outreach to Underserved Communities/ eXtension Communication & Marketing**

## **Session 3 L**

**Track/Session: Outreach to Underserved Communities/General Education: How to's**

### **Keeping the Reach in Outreach**

*Barbara Norman, Michigan Food and Farming Systems, East Lansing, MI*

### **Keeping the Reach in Outreach**

**Barbara Norman**

Michigan Food and Farming Systems, East Lansing, MI

### **Introduction**

Good morning, my name is Barbara James Norman, I live on a blueberry farm in Covert, on the beautiful shores of Lake Michigan. I am a third generation owner and fourth generation operator on the same land that my great-grandfather farmed. My family is six generation on the land. If there's any interest about that and/or blueberries, I'd love to talk to you in detail later.

I want this session to be really meaningful; we all need to leave with a carry out item. Outreach should begin now in this room. If you are here you are very special people, with a desire to make a difference (help). Let's start right now so you can get a feel of how I work, how it feels, and most important if any



part of it will fit in your outreach approach. I can glean some things from each of you. One simple formula for Outreach is to meet, greet, share and continue expanding our resources. Please can we take a couple of minutes to change our seats. Let's quickly put our chairs in a circle then seat next to someone that you don't know try to end up sitting between two friends that you haven't met yet. Quickly let's do this. I'm here today to share some and hear some dialog about outreach. We want to talk about the importance of OUTREACH in our daily work, in the projects we do.

Outreach establishes and maintains contacts with your targeted audiences. It keeps your customers up-to-date on changes. To be effective, you have to begin by building relationships through common interest and have a strong knowledge base around the subjects. In the world of agriculture along with your strategic plan you must know something about farming, marketing, etc. It is vital that you have some knowledge of USDA programs (not just grant programs) the ones that the producers need and will benefit them. We need (not should) to know and have a working relationship with local (usually county), state, regional offices, and who to contact for each program. You need to know which agency does what. It would be an advantage to have some knowledge of the national agricultural scene. Ongoing community outreach is important outreach. Outreach will greatly increase your measurable outcomes. Overall, outreach efforts are important for effective RESULTS. At the conclusion of this session I'd like everyone here to leave with a warmer, more personal feeling about the powerful reach of the act of reaching out.

### **Outreach Idea**

The basic underlining principle of outreach is: to start where the customer is! Outreach demonstrates a willingness to go the customer rather than waiting on the customer to come to you. Encourages potential audiences to participate in programs that would benefit their needs. That is the real outreach idea. What do we consider as outreach? Response? This is a time consuming task and an ongoing process.

Think what our office hours are. Are we flexible, if we're going to the farmers, are we going when it is good for them? Even setting up meetings, gatherings are they set more on our times or days and times that are suited more for the presenter and/or staff. We must be sensitive remembering that most small farmers have an off farm job; if it's far away time is important. We should think also about conferences and the consequences of time off for the farmer; for instance, if there's a fee for attending a conference and cost of travel and who will be taking care of the farm while the farmer is away?

Do find a way to engage people in conversations.

This is where we will pause and allow you to use 2 minutes to engage in a conversation with someone sitting next to you. Now do you think when you see this person again doing this conference, or at the airport will you reminder them.

Will you engage in another talk? Did anything meaningful happen?

### **Know Your Targeted Audiences**

Target Population is described with terms of demographics, social and behavioral characteristics. For example: gender, sexual orientation, age, race, ethnic makeup, geographic location, and behavior.

Now let's look at our projects individually.

All project should have a needs assessment, as your project grows all farmers may not need one, you need to keep the talk open for changes, or needed updates. Farmers will make your structure grow and bring new people into the circle. Farmers learn from farmers.

Outreach workers must use their listening skills to learn the needs of the ones they serve. Active listening will help you learn what your farmers' needs are and how to better serve them. This is where your knowledge base and resource time are critical for many reasons, time of season, deadlines for program participation, marketing, crops, etc.

### **Conclusion**

Please remember we must remain consistent, visible and that "one size does not fit all"

The ability to effectively conduct outreach is one of skills, talents, and commitment. Outreach people should be respected and recognized as professionals.

Lets' all continue to work together across groups, states and people for the betterment of the whole of agriculture.

## **Session 3 M**

**Track/Session: Research and Extension Priorities/Managing Agricultural Risk IV**

### **Nitrogen Management in Organic Vegetables**

*Nick Andrews and Dan Sullivan, Oregon State University, Corvallis, OR*

#### **Nitrogen Management in Organic Vegetables**

**Nick Andrews and Dan Sullivan**

**Oregon State University, Corvallis, OR**

We are working with organic and conventional farmers to enhance their ability to manage nitrogen (N) in vegetable rotations. Organic farmers and others striving to implement sustainable methods often incorporate compost, cover crops and other organic amendments into their rotations. These practices increase soil organic matter (SOM) content and soil fertility. They also save money because plant-available N (PAN) from specialty organic fertilizers is at least five times more expensive than PAN from conventional N fertilizers.

N mineralization from soil organic matter and organic amendments is difficult to quantify. We are developing tools to support site-specific N management decisions on organic vegetable farms. In 2006, we introduced the Organic Fertilizer Calculator which integrated N mineralization models for organic fertilizers (Gale et al., 2006) and compost with a fertilizer cost calculator. From 2007-2011 we conducted lab and field research to investigate PAN release from cover crops. In 2010 we launched the Organic Fertilizer and Cover Crop Calculator (Andrews et al, 2010) by adding a cover crop mineralization model and management cost worksheet. Now we are starting to use aerobic soil incubations to identify soils with different N mineralization potential.

We are using the decision process outlined in Figure 1 to adjust N fertilizer recommendations in different fields. Organic fertilizers release PAN gradually during the first 4-6 weeks after application. This delay makes it difficult for organic farmers to use pre side-dress nitrate tests [PSNT], (Hart et al., 2010) to determine the need for supplemental N. Therefore, our focus is on pre-plant N management decisions (discussed below). The mid-season check is a soil nitrate-N test sampled just before the main period of crop N-uptake (PSNT timing) to make sure enough N was applied before planting. We use a sufficiency level of 25-30 ppm, which has been validated for many vegetable crops across the U.S., and is consistent with research in Oregon. Sufficiency levels for tissue tests vary by crop. The end of season soil nitrate test indicates whether N supply from all sources exceeded plant N uptake. It can be used to refine the choice of winter cover crop species (i.e., cereal vs. legume) and adjust soil amendments for the following crop. We aim for low to medium residual nitrate-N levels using the following guidelines for ppm nitrate-N in the surface foot:

- Low: <10 ppm
- Medium: 10-20 ppm
- High: 20-30 ppm
- Excessive: >30 ppm

Fields planted to vegetables in mid-late summer can often be managed more simply with a soil nitrate-N test taken at least 4 weeks after cover crop incorporation. By mid-summer, SOM has already mineralized enough N to estimate supplemental fertilizer requirements.

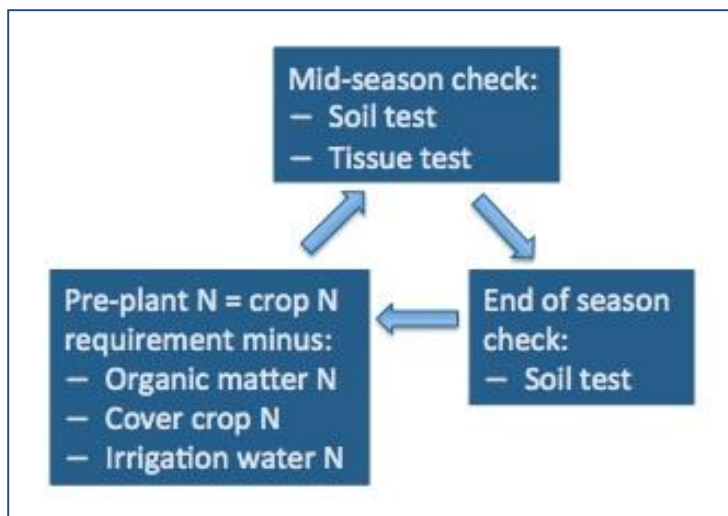

Figure 1. Our recommended decision process for determining site-specific fertilizer N requirements in organic vegetables continues from year to year.

### Pre-plant Nitrogen

Pre-plant N requirements can be determined by subtracting N credits (organic matter, cover crop and irrigation water) from crop N requirements (Figure 1) available from University fertilizer and nutrient management guides. In western Oregon and Washington, N is leached from soil during heavy winter rains from November to March. Spring soil nitrate-N levels are consistently below 10ppm. PAN is gradually released from SOM as soil temperatures rise above 50°F in the spring. Cover crops provide most of their PAN contributions within 4-6 weeks of incorporation. Irrigation water may contribute nitrate-N during the irrigation season if levels in well water are higher than about 5ppm determined as follows:

$$\text{Nitrate-N (lb/ac)} = \text{inches water applied} \times \text{ppm nitrate-N} \times 0.227$$

### Cover Crop PAN

During decomposition a cover crop can increase or decrease the N fertilizer requirements of the following crop. In general, legumes have higher N content than cereals and leafy plant tissues have higher N concentrations than stems and more mature plant material. For legumes like common vetch that are high in N (e.g., 3 percent), about half of the cover crop N is released as PAN, because the cover crop has more N than needed to “build” soil organic matter. For non-legumes like cereal rye that are low in N (e.g., 2 percent), the release of PAN is small, because most of the cover crop N goes into soil organic matter. As cereals mature and start heading, their N content drops (e.g., 1 percent) and PAN is immobilized (negative PAN) during decomposition. Most of these changes in N levels occur in the first 4-6 weeks after plowdown.

Trials over the last few years give new insight into the amount of N that is mineralized (positive PAN) or immobilized (negative PAN) by cover crops. Garrett and Luna compared the response of broccoli to different rates of N fertilizer (applied as feather meal, 12-0-0) and cover crops. They found that common vetch cover crops replaced about 110 lbs of total N from feather meal, and that an additional 50 lbs total N from feather meal was needed to counteract immobilization by an oat cover crop.

We conducted laboratory incubations to measure the amount of N mineralized by different cover crop residues. Field trials verified the results of the lab work. Our results were consistent with research done in Kansas to predict PAN from crop residues. Total N content of a cover crop can be used to provide useful estimates of cover crop PAN (Table 1). Our estimates for cover crop PAN are applicable to Oregon and Washington west of the Cascade Mountains and should be used with caution in other cropping systems (Sullivan and Andrews, in press).

In order to estimate cover crop PAN we recommend field sampling and analysis of a whole-plant aboveground sample. The cover crop is harvested from a known area in the field, weighed wet, then subsampled. The subsamples are sent to an analytical lab for determination of % dry matter (DM), cover crop biomass (dry weight) and total %N in DM.

Table 1. Predicted plant-available N (PAN) release from cover crops.

Your Cover crop Total N <sup>1</sup>		Predicted PAN release <sup>2</sup>		
%N in DM	lb/ton in DM	4-wk	10-wk	Calculator
		lb PAN released per ton DM		
1.0	20	<0	0	0
1.5	30	3	9	4
2.0	40	7	14	9
2.5	50	12	20	16
3.0	60	19	28	24
3.5	70	28	37	33

<sup>1</sup>Total N analysis of your cover crop sample performed by a commercial laboratory, or “typical value” for the cover crop. 1% N in DM = 20 lb N per dry ton.

<sup>2</sup>PAN predictions: 4 and 10-week = estimated by incubation of cover crop residue in moist soil at 72°F. Calculator = estimated by Oregon State University Organic Fertilizer and Cover Crop Calculator

#### Organic Fertilizer and Cover Crop Calculator

This online calculator is an Excel spreadsheet that calculates cover crop DM and total N. An equation that matches the calculator column in Table 1 estimates the PAN released from cover crops. Similar equations estimate PAN from organic fertilizers and compost.

A cover cropping enterprise budget is incorporated in the calculator to allow comparisons of cover crop and fertilizer costs based on actual farmer costs for seed, fuel, labor, etc.. The spreadsheet helps growers

credit cover crop N and find the most cost-effective supplemental fertilizer program that matches crop nutrient requirements. For example, a 30-acre organic farm is growing broccoli. The farmer uses a 70 hp tractor and pays \$4/gallon for diesel, \$10/hour for labor, \$0.70/lb for common vetch seed, and \$1000/ton for feather meal. Assume they drill the seed and irrigate once to establish the cover crop; then they flail mow, chisel plow and disc to incorporate the cover crop. A healthy stand of vetch providing 60 lbs/ac of PAN/ac would cost about \$138/ac (\$2.30/lb PAN). The same amount of PAN from feather meal costs about \$326/ac (\$5.40/lb PAN).

### Soil Organic Matter PAN

Soil organic matter is the product of microbial decomposition of plant and animal material. During microbial decomposition of any organic amendment, a portion of the carbon is decomposed (lost from soil as carbon dioxide). The remaining carbon is transformed by the decomposition process, yielding fresh soil organic matter with a carbon to nitrogen ratio of approximately 12:1. The biologically active fraction is derived from organic material applied in the previous five years or so. After about 5 years the material becomes more stable humus, which does not release PAN. Biologically active SOM is a small fraction (i.e., 30 percent) of the total organic matter, but is responsible for most nutrient mineralization.

Application of organic amendments can increase the N mineralization potential of soil fairly quickly. Sullivan *et al.* (2003) applied about 69 tons/ac of food waste compost before planting tall fescue. The compost contained approximately 2,000lbs/ac N. As the compost decomposed, apparent nitrogen recovery by tall fescue was 101 lbs/ac in year 2 (4.8 percent of total N), 83 lbs/ac in year 3 (3.9 percent), and 37-55 lbs/ac in years 4-7 (1.8-2.6 percent).

Two fields from our trials with similar soil and different management histories illustrate the role of organic matter in N cycling (Figure 2). Farm A has Cloquato silt loam with a 10-year history of cover crops, the farmer was seen to regularly raise vigorous cover crops with an estimated 2-3 tons DM/acre. Farm B has Willamette silt loam with one year of cover crops. Nitrate-N was monitored in cover cropped and fallow plots with no fertilizer. The farmers double cropped lettuce and kale at farm A and grew popcorn at farm B. N mineralization from organic matter increased soil nitrate-N content until the crops were large enough to utilize the N in July and August. Before significant crop N-uptake soil nitrate-N levels peaked above 30 ppm at farm A where cover crops had increased soil organic matter levels, and stayed below 10 ppm at farm B where there was little history of cover cropping.

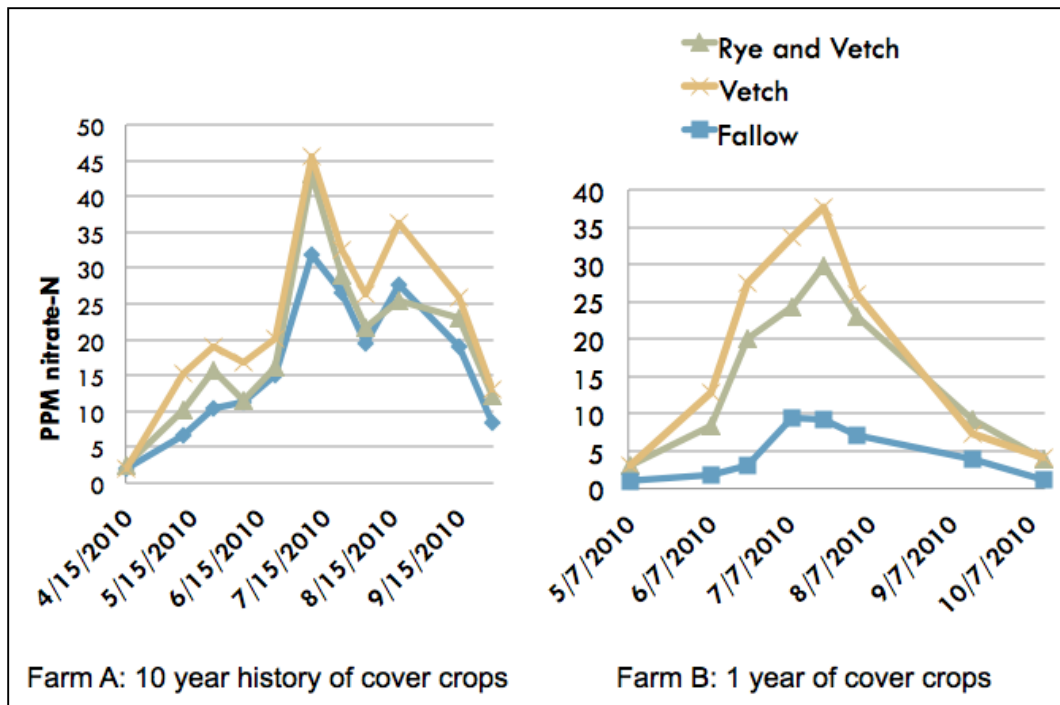

Figure 2. Soil nitrate-N levels in plots with no cover crop on two silt loam soils. Field A has a 10-year history of high biomass cover crops, Field B had 1 year of cover crops.

Most routine soil analyses use the “loss on ignition” method to measure total organic matter (biologically active + humus) lost at 360°C for 2 hours. Estimates of N release based on total percent organic matter do not correlate well with direct measurements of N mineralization potential.

We are beginning to use aerobic soil incubations and zero-N plots (Sullivan *et al.* 2008) to estimate PAN release from soil organic matter. We screen and moisten the soil to 22-35 percent gravimetric soil moisture depending on soil texture, and incubate the soil in plastic bags kept open with a straw to maintain aerobic conditions. N mineralization potential is calculated as:

$$\text{N min potential (ppm/day)} = (\text{final nitrate-N} - \text{initial nitrate-N}) \div \text{number of days.}$$

We are differentiating soils by their N mineralization potential: low (0-0.3 ppm/day), medium (0.3-0.6 ppm/day), high (0.6-1.2 ppm/day) and very high (>1.2 ppm/day).

We hope to identify a test that organic vegetable growers could use to estimate the N mineralization potential of their soil. Such a test would improve the accuracy of pre-plant N estimates in the decision process in Figure 1.

## Acknowledgements

This work was financially supported by a partnership with Oregon Tilth, Inc. and the West Multnomah Soil & Water Conservation District, and by grants from USDA Western Sustainable Agriculture Research & Education.

## References

Andrews, N., D. Sullivan, J. Julian, and K. Pool (2010). "OSU Organic Fertilizer and Cover Crop Calculator." Online at <http://smallfarms.oregonstate.edu/calculator>. [Retrieved month, day, year ]

Gale, E. S., D. M. Sullivan, C. G. Cogger, A. I. Bary, D. D. Hemphill, D. D. and E. A. Myhre, (2006). "Estimating Plant-Available Nitrogen Release from Manures, Composts, and Specialty Products." *Journal of Environmental Quality*. 35:2321-2332.

Hart, J. M., D. M. Sullivan, J. R. Myers and R. E. Peachey (2010). Sweet Corn (Western Oregon) Nutrient Management Guide. Oregon State University Extension Publication EM 9010-E, Corvallis, OR.

Sullivan, D. M., A. I. Bary, T. J. Nartea, E. A. Myrhe, C. G. Cogger and S. C. Fransen (2003). "Nitrogen Availability Seven Years After a High-Rate Food Waste Compost Application." *Compost Science and Utilization*. 11 (3):265-275.

Sullivan, D. M. and N. D. Andrews (in press). Estimating Plant-available Nitrogen Release from Cover Crops. Pacific Northwest Extension Publication. PNW 636, Corvallis, OR

Sullivan, D. M., McQueen, J. P. G. and Horneck et al (2008). Estimating Nitrogen Mineralization in Organic Potato Production. Oregon State University Extension Publication EM 8949-E, Corvallis, OR.

Vigil, M. F. and D. E. Kissel (1991). "Equations for Estimating the Amount of Nitrogen Mineralized from Crop Residues". *Soil Science Society of America Journal*. 55:757-761.

## Oral Presentations

## Session 4

**Track/Session: Alternative and Traditional Enterprises/Organic Practices**



## **The Financial Performance of Dairy Systems Across the U.S.A.**

*Thomas S. Kriegl, University of Wisconsin Center for Dairy Profitability*

### **The Financial Performance of Dairy Systems across the U. S. A.**

**Thomas S. Kriegl**

**University of Wisconsin Center for Dairy Profitability**

**University of Wisconsin-Extension**

**Madison, WI 53706**

#### **Methods**

Summarized data was supplied by the accounting firms of Frazer, LLP; and Genske, Mulder, and Company, LLP; Cornell University; the University of Florida; the University of Maine; the University of Maryland; Michigan State University; the University of Minnesota; the University of Vermont; and the University of Wisconsin Center for Dairy Profitability where the comparisons were made.

Several measures should be examined when analyzing financial performance and economic competitiveness because no single measure tells the whole story. However, one usually is limited to just a few measures to explain the results. The primary measure used for illustration in this report is net farm income from operations (NFIFO) as a percent of dairy farm revenue based on accrual adjusted income and expenses. A similar measure is used in the non-agricultural business world.

The use of this measure is driven mainly by large variations in the milk price received and in the pounds of milk sold per cow by the many systems and states in the comparison.

In comparing the financial performance of dairy systems across an area as large and diverse as the United States, it is very possible that unique climatic or other conditions can cause the financial performance of any place in any year to be abnormal. A good way to minimize the impact of such unique influences is to compare several years of data. To make the comparison of this large amount of data more manageable, multiple year simple averages were calculated for all systems. Some of the averaging was done by the source of the data and some was done by the author of this report.

Farm financial data collection and analysis (even from reliable sources) is far from uniform across the country. When such data is obtained from many different sources, some differences will remain. One of the differences is that data from different sources may have different time periods.

All of the data presented in the longest year periods in the analysis have also been compared in the same period with the shorter period data to verify that no change in the observation and conclusions would occur if the comparisons were shown in the same but shorter periods in most cases.

**Large confinement systems rely much more on hired labor than the other three systems. This explains part, but not all of the difference in their NFIFO/\$ revenue.** To get a better sense of the impact of the cost of paid labor on the relative performance, the NFIFO/\$ revenue was calculated in the standard way and recalculated and ranked by what NFIFO/\$ revenue would be if all labor was unpaid. Although this ranking for a few dairy systems changes noticeably between two measures, most dairy systems retain a very similar ranking from one to another measure.

**This comparison reveals the following major observations:**

- 1. It is unlikely that any dairy system in any state will always be the low cost or most economically competitive producer under all circumstances. The ability to stay in business can also be influenced by factors not readily identified as economic. Some of that can be observed in 2009 data.**
- 2. This economic dairy data indicates that the economics of scale (lowest cost of production per unit) occur at a much smaller size than people expect (somewhat less than 100 cows per farm).**
- 3. There were large consistent differences in NFIFO/\$ revenue between many states and systems.**
- 4. Graziers have typically attained more NFIFO/\$ revenue than other dairy systems in their states.**
- 5. Despite being high cost producers, the larger and more consistent organic price premiums over conventional price have improved organic dairy farm financial performance since 2005 in states that have data available.**
- 6. Wisconsin dairy systems have often attained more NFIFO/\$ revenue than similar dairy systems in other states.**
- 7. Small dairy systems have typically attained more NFIFO/\$ revenue than large dairy systems in the same state.**
- 8. The largest farms tend to generate more dollars of total NFIFO per farm and per owner compared to the smallest farms.**
- 9. The economic forces encouraging growth of dairy production in the west may have shifted a bit more in favor of the mid-west since about 2005.**
- 10. The ranking of financial performance by state is very different from the official USDA cost of production estimate ranking which relies very heavily on opportunity cost.**
- 11. NFIFO per owner has probably driven expansion more than NFIFO per unit.** Family-size farms (the size that can be operated mainly by family labor) are fairly similar across states in terms of the total NFIFO they generate. However, the size of family-size farms can be quite different from state-to-state. For example, Wisconsin grazing farms have about half as many cows as Michigan grazing farms, and nearly double the margin of NFIFO/\$ revenue in the table. This somewhat challenges the assumption that farm

size increases are motivated by economics of scale (increased size increases margins). In fact, the data suggests the opposite. The data suggests that in parts of the U.S. where profit margins are lower, people who want to make a living from dairy farming, operate larger farms because the larger size offsets lower margins to achieve a desired amount of NFIFO from their career choice. Wisconsin graziers could be as large as Michigan graziers and likely generate much more total NFIFO, but may not do so because they can generate as much total NFIFO as Michigan graziers with smaller herds, less work, less stress, etc. The amount of non-farm income was not available from most data sources.

**There are some public policy implications from the above observations.** Some government policies encourage increased dairy farm size and are often justified, at least partly, because larger farms are presumed to have economies of scale (lower cost of production). However, this actual farm financial data suggests that the larger farms may not be more economically efficient than smaller farms. Future public policy decisions should consider this information along with environmental and social factors associated with each system.

### **Further Discussion – Economics of Scale**

The term “economies of scale” has a much more specific meaning to economists than it does to non-economists. The theory of economies of scale says that as a business gets larger, it can spread its fixed costs over more production units and reduce the total cost of production per unit as more units are produced. The theory also says that at some size, cost per unit no longer declines, and in fact can increase if further “growth” occurs, creating diseconomies of scale.

The perception of economies of scale of large confinement farms probably came from the misunderstanding of the concept of economies of scale. If one built a facility for 1,000 dairy cows but populated it with only 100 cows, the resulting fixed and total costs would be extremely high. These fixed and total costs would be reduced with each increment of 100 cows added up to the capacity of the dairy facility. While costs decline as more and more of the facility’s capacity is used, this is not economy of scale. If the properly designed 1,000 cow facility operated at full capacity has lower costs than the properly designed smaller facility operated at full capacity, then this would demonstrate economies of scale. So far, the data suggests those economies of scale peaks somewhere less than 100 cows when comparing different farm sizes within several states.

**While being the low cost producer is a tremendous economic advantage, being the lowest cost producer may not be required for survival.** New Zealand is considered to be the world’s low cost dairy producer. If New Zealand could produce all of the dairy products the world could consume and barring excessive transportation costs and government intervention, they could put all other dairy producers out of business. However, they lack the productive capacity to supply the whole world. Therefore, higher cost producers can compete outside of New Zealand.

**While achieving economies of scale or being the low cost producer is a tremendous economic advantage, it isn’t the only economic advantage that a business may have.** Non-economists often call these other economic advantages economies of scale. An example of one of these economic

advantages is that large Wisconsin confinement farms have received significant milk volume premiums that enhance the income side of the equation for them even if it hasn't made their costs lower. Another economic advantage enjoyed by larger farms is that a lender is more reluctant to foreclose on a large operation than on a small farm, assuming the financial performance of the two farms in the example is similar.

All dairy systems in all areas (not necessarily every dairy farm) had desirable farm financial performance in 2007, which was one of the best years in the U.S. dairy industry.

In contrast, in the worst year of the century for U.S. dairy farms (2009), the grazing and organic herds had better financial performance than other systems and small confinement herds had better financial performance than large confinement herds in the data.

In 2009, large dairy farms seemed to experience a different economic disadvantage – the greater willingness of the owner/operator of a small farm to reduce their “own wages” more than employees may be willing to accept.

The farms with the strongest solvency (high cost basis asset values with little or no debt) positions across all systems also fared better in 2009 than their counterparts regardless of their cost of production. Reaching a strong solvency position is rare for high cost producers.

Despite the long time trend toward fewer and larger farms, the actual farm financial data (often in contrast to models) suggests that “skilled and motivated manager/owners can achieve financial success on small dairy farms.

## **Session 4 B**

**Track/Session: Marketing Opportunities/Women in Agriculture**

## **Session 4 C**

**Track/Session: Outreach to Underserved Communities/USDA Collaborations & 2012 Ag. Census**

## **Successful NASS-CBO Partnership Initiatives**

**Hubert Hamer**, USDA/ERS, Washington, DC; **Ginger Harris**, USDA/NASS, Louisville, KY;  
**Michelle Radice**, USDA/NASS, Washington, DC

## **Successful NASS-CBO Partnership Initiatives**

**Hubert Hamer**

**USDA/ERS, Washington, DC**

**Ginger Harris**

**USDA/NASS, Louisville, KY**

**Michelle Radice**

**USDA/NASS, Washington, DC**

As framed by its mission statement, USDA's National Agricultural Statistics Service (NASS) provides timely, accurate, and useful statistics in service to U.S. agriculture. NASS conducts hundreds of surveys every year and issues reports covering virtually every aspect of U.S. agriculture. NASS provides objective and unbiased statistics on a preannounced schedule that is fair and impartial to all market participants.

NASS is committed to report the facts on American agriculture, facts needed by people working in and depending upon U.S. agriculture. Production and supplies of food and fiber, prices paid and received by farmers and ranchers, farm labor and wages, farm finances, chemical use, and changes in the demographics of U.S. producers are only a few examples.

NASS conducts over 400 surveys annually with the support of many state departments of agriculture, land-grant universities, community-based organizations (CBOs), and agricultural industries. Through its network of field offices, NASS works closely with its partners to collect detailed data and deliver survey results on commodities important to local economies, county estimates, and other agricultural items not covered by federal funds. NASS also conducts the Census of Agriculture every 5 years, providing consistent, comparable, and detailed agricultural data for the nation. The census is a complete count of America's farms and ranches and the people who operate them. It is the most comprehensive set of agricultural data available and is the only source of uniform and objective agricultural information for every county in the nation. NASS now conducts the Census of Agriculture in all 50 states, Puerto Rico, Guam, U.S. Virgin Islands, Commonwealth of Northern Mariana Islands, and American Samoa. The census gathers information on land use and ownership, operator characteristics, production practices, income and expenditures.

NASS is preparing to conduct the 2012 Census of Agriculture and NASS state and national personnel are again reaching out to small and underserved producers to help them understand how the census data benefits their operations.

During the 2007 Census of Agriculture cycle, NASS successfully engaged community-based organizations (CBOs), land-grant institutions, nongovernmental organizations (NGOs), and other stakeholders in a collaborative effort that ensured that U.S. producers nationwide were represented in the census data. NASS has documented the best practices and lessons learned in engaging with partners and stakeholders that led to increased counts for small, new and beginning, and minority farmers and ranchers (see Figure 1) and will build on these practices for the 2012 census. The 46 NASS Field Office Directors and Deputy Directors spend a considerable amount of time and effort reaching out to all producers, regardless of size of the agricultural operation, in their respective states. NASS field staff work closely with their partners to educate producers on the benefits of completing NASS surveys and being represented in data tabulated and published for the producers' counties or states. CBOs, land-grant institutions, and some faith-based organizations have proven to be invaluable partners in assisting NASS field staff with identifying and then reaching out to underserved operators. CBOs and other NASS partners occasionally assist NASS in survey promotion and data collection activities, as well as enhancing list building efforts through outreach. Field office directors quite frequently speak to commodity groups, farm and ranch organizations, race-, ethnicity-, or gender-based organizations, and colleges and universities regarding NASS survey data, survey methodology, and the benefits of receiving and completing NASS surveys. This grass roots approach ensures that our Directors, Deputy Directors, and the field office workforce are sensitive to data needs and respondent concerns in their regions. This is a key component for outreach and education efforts in the field setting.

The NASS field office directors and headquarters staff also work closely with land-grant colleges and other universities to promote career opportunities, and realize the indirect benefit that students and academia are made more aware of the vast amount of data that NASS provides. These relationships expand the outreach network as educators reach students of all ages in the agricultural community. Through this successful initiative, NASS partners played key roles in helping producers understand the importance of the census data that is used by producers, educators, federal agencies, policymakers, and legislators. These partnerships continued in the data collection phases of the census as well.

Once census data collection was complete, NASS produced customized census products for its different partners for them to use to show their constituents how the census data can be used as supporting documentation for grants, discussed with legislators to identify gaps or barriers, or to demonstrate the need for more programs and assistance in underserved areas of the country.

Through another collaborative initiative, NASS staff and representatives from three Texas CBOs have authored a NASS-CBO Partnering Handbook that highlights the techniques and methodologies used in collaborations where partners assisted NASS with the promotion of the importance of the agricultural census, as well as promoting other programs in USDA. The guidebook discusses effective ways that CBO-NASS partnerships can exist and be fruitful in NASS's continuing effort to reach all operators, and

talks about CBO efforts to ensure all operators are aware of and can take advantage of the many USDA programs.

NASS works closely with approximately 50 national and local CBO partners on a continuing basis, and looks to include more CBO partners over time. NASS has conducted two partnering workshops that hosted representatives from the CBOs for a 3 to 4 day session, and are planning a third. NASS staff and CBO advisors collectively develop the training/discussion curriculum and outline the idea exchange sessions. These CBO Partnering Workshops have occurred approximately every 18 months, and the hope is that trend will continue in the future. Currently, NASS has agreements with three CBOs that showed strong initiative in the areas of promotion, outreach, and data collection during the 2007 Census of Agriculture cycle.

In Headquarters, the senior executive staff are frequent and willing presenters at regional and national meetings to many of the race-, ethnicity-, or gender-based organizations, commodity groups, and farm and ranch organizations. This top-down commitment to education and outreach is pervasive, and it in turn, lends itself to be an attitude which is adopted by all in NASS.

As the NASS outreach initiative has blossomed, NASS has assigned one full time staff person to devote her time entirely to formulating, recommending, coordinating, implementing, administering, and monitoring a comprehensive program of outreach to small and/or minority operated farms and ranches and to rural residents in support of program delivery for Headquarters and Field Offices. The Outreach Coordinator serves as the focal point for diversity outreach and small farms initiatives, develops Agency-wide standards and policies for the implementation and administration of the diversity outreach efforts, serves as the liaison with USDA and outside organizations on such matters, and provides the Agricultural Statistics Board Chairperson the necessary guidance critical to the success of a comprehensive program. NASS staff remains fully committed and engaged in maintaining and expanding partnerships with our CBOs, land-grant institutions, universities, NGOs, data users and data providers in the agricultural sector.

NASS looks to elicit feedback or best practices used by others to continue to strengthen relationships and enjoy successful partnerships with CBOs its efforts for successful outreach for the 2012 Census of Agriculture cycle.

## **Session 4 D**

**Track/Session: Outreach to Underserved Communities/Farm Service Agency**

## **Session 4 E**

**Track/Session: Research and Extension Priorities/Next Generation of Farmers**

## **Identifying Barriers that Prevent Hispanic/Latino Farmers & Ranchers in Washington State from Participating in USDA Programs and Services**

### **Identifying Barriers that Prevent Hispanic/Latino Farmers & Ranchers in Washington State from Participating in USDA Programs and Services**

#### **Rural Community Development Resources (RCDR)**

#### **Center for Latino Farmers, Yakima, WA**

#### **Primary Researchers: Juan Marinez, Michigan State University**

#### **R. Edmund Gomez, New Mexico State University**

Hispanic/Latino farmers and ranchers have been a vital component in Washington State agriculture as far back as the 1920's. According to the U.S. Decennial Census of the period, data in the early years recognizes their presence not only as farmworkers but as farm/ranch owners as well. Based on the data collected by USDA beginning with the 1987 Census of Agriculture, (first year that Hispanic/Latino farmer and rancher data has been gathered) Hispanic/Latino farmers and ranchers have been increasing in numbers exponentially in Washington State. In 20 years, according to the USDA National Agricultural Statistic Service (NASS) data, Hispanic/Latino farmers and ranchers have increased their numbers by just over **701%** (1987-325 to 2007-2,604); this represents **7%** of the total number of farmers and ranchers in Washington State. Nationally, Washington State Hispanic/Latino farmers and ranchers represent over **4%** of the total number and as of the 2007 Census of Agriculture, they are now ranked **6<sup>th</sup>** nationally.

Based on NASS data, Washington State Hispanic/Latino farmers and ranchers are the fastest growing Hispanic/Latino farmer and rancher group outside of the Southern U.S. Border States and the fastest growing farmer and rancher socially disadvantaged group in Washington State. Interestingly, based on this current USDA data, Hispanic/Latino farmers and ranchers appear to have the lowest participation rate of USDA programs when one compares them to other socially disadvantaged farmer and rancher groups, and proportionately, are underrepresented on USDA boards, committees and grants allocations to socially disadvantaged farmers and ranchers within USDA agencies.

The Rural Community Development Resources, Center for Latino Farmers (Center) applied for a USDA Outreach and Assistance to Socially Disadvantaged Farmers and Ranchers (OASDFR) Competitive Grant Program – Round 2 RFA in an effort to enhance the coordination of outreach, education, and technical assistance efforts for the Socially Disadvantaged Hispanic/Latino farmers and ranchers in Washington State. On October 28, 2010, the Center was awarded an OASDFR grant to collect Hispanic/Latino farmer and rancher data that would identify barriers to accessing USDA services and programs; through surveys, focus groups, workshop training sessions and individual interviews. The primary purpose of the grant was to enhance the coordination of outreach, technical assistance and education efforts to reach socially disadvantaged farmers and ranchers by USDA.

The overall goal of the project was to define the barriers, whether real or perceived, to equitable participation and utilization of USDA programs and services by Hispanic/Latino farmers and ranchers, beginning at the local USDA service centers in Washington State. It is the intent of the research study that the data could be used to develop recommendations to USDA that would result in an improved outcome of service to the Hispanic/Latino farmers and ranchers and rural communities of Washington State.



The project study target audience was identified as all USDA service providers, and the Hispanic/ Latino farmers, ranchers and farmworkers with special focus on the Mexican immigrants, and new and beginning farmers and ranchers from the following counties in Washington State: Yakima, Benton, Adams, Okanogan, Grant, Chelan, Douglas, and Franklin. The Hispanic/Latino farmers and ranchers targeted for this study present unique characteristics as they are an immigrant, first-generation, mono-lingual community who have settled in Washington State over the past years and have become a vibrant entity within Washington State agriculture. The mentioned counties along with the farmers and ranchers selected for the study represented, proportionately, the most current 2007 agriculture census data of Hispanic/Latino farmer and rancher county concentrations and would represent the target audience statistically. These counties also have a very strong agriculture based economy and are experiencing a great number of Hispanic/ Latino farmworkers transitioning into farm ownership.

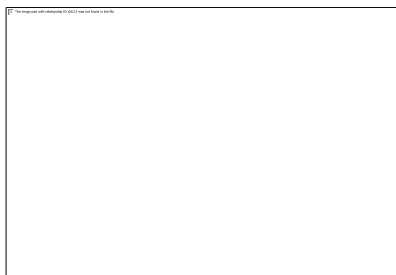

Target Counties

The Stakeholder and Partner Listening Session/Small Farm Conference was held on February 24, 2011 in Yakima, WA with a special interest in inviting Hispanic/Latino farmers and ranchers from the target counties as attendees. This was the beginning of the series of workshops and programs from which participants were recruited for the remaining project educational activities. At this first session, all of the participants were introduced to *Turning Point*® which is a tool used to conduct surveys. This tool was especially selected for this research study because it offered an ease of response with which the Hispanic/Latino farmers and ranchers could participate.

USDA service providers in the target region were also identified as part of the target audience. As a major component of the project study, the project made special efforts to survey all USDA FSA, NRCS, RMA and RD service providers in the target counties. The survey instrument selected was *Survey Monkey*® and it had been scheduled to be administered through the internet on the last week of June 2011. Permission from USDA was requested by the project researchers as a matter of research protocol; regrettably, when the request was sent to an upper administrator at USDA, a barrier at the USDA Office of Civil Rights in Washington, D.C., prevented the survey from being administered to USDA service providers in the targeted counties.

Based on the concept that a relationship must have a minimum of two parties, and both must interact, it is only logical that for the research to be complete, both the Hispanic/Latino farmers and ranchers and the USDA service providers must have a voice in identifying barriers in order for any changes and/or recommendation to have validity to real or existing barriers. If the proposed USDA survey would have been administered to USDA service providers, they would have had an opportunity to provide constructive, yet anonymous input into the process. If barriers would have been discovered through this process, it had been the intent of the researchers to recommend possible solutions to those barriers that had been identified by the USDA service providers in the same fashion that were developed from data collected from the Hispanic/Latino farmers and ranchers surveyed in this project; thus, regrettably, the study is providing and reporting only half of the data originally proposed.

The research used a mixed method of sequential explanatory design consisting of two phases: quantitative followed by qualitative. Data was collected through descriptive survey instrument *Turning Point*®, focus group discussions, listening sessions and one-on-one interviews. Selected demographic outcomes are:

- 62% of the farmers surveyed were under 50 years of age, while 32% were between 51 and 60 years of age

- 92% of the Hispanic farmers surveyed in Washington have lived in the US for 11 or more years, and of these, 78% have lived in the U.S. 20 or more years
- 58% surveyed are U.S. citizens and 42% are legal residents; this distribution of citizenship reflects that 100% are legal U.S residents
- 75% of the Washington State Hispanic/Latino farmers surveyed are currently farm workers while owning and operating their own farms
- 13% of farmers surveyed, have paid off the farm mortgage, 48% are making mortgage payments, while the others are leasing farm land
- 45% of farmers surveyed have owned their farms for six years or more
- 52% learned their farming practices in Mexico, while 39% learned their skills in the U.S.
- 77% of farmers surveyed had been farm workers before purchasing their own farm
- 49% of Washington State Hispanic/Latino farmers surveyed, own more than 40 acres of farm land
- 39% of farmers surveyed have not received assistance in their farming operations
- 61% of Hispanic/Latino farmers in Washington State surveyed have knowledge of FSA and 22% for NRCS, yet 13% are not aware of any of the USDA agencies
- only 33% of farmers surveyed have been assisted by FSA, 17% assisted by NRCS, 5.7 % assisted by Cooperative Extension Service, while 34% stated that USDA has not assisted them at all
- only 31% of Hispanic/Latino farmers surveyed participated in the 2007 Census of Agriculture

The objectives of the project have led to identifying the reasons, whether perceived or real for barriers that confront Hispanic/ Latino farmers and ranchers when they request service and participation in USDA programs, or why they have not requested USDA services in the past. In addition, the research study identified barriers at USDA that prevented the USDA service providers from fully assisting the Hispanic/Latino farmers and ranchers in achieving these programs. When barriers were identified by the target audience, recommendations were formulated based on Hispanic/Latino farmers and ranchers input on how to overcome these barriers.

As the study progressed, the researchers realized that there were two distinct sets of barriers that prevented or contributed to the lack of equitable participation and utilization of USDA programs and services by Hispanic/Latino farmers and ranchers in Washington State. The study identified barriers within USDA agencies and their service centers as well as within the Hispanic/Latino farmers and ranchers as identified by the Hispanic/Latino farmers and ranchers interviewed in the study. In addition, the researchers encountered an obstacle in attempting to access data from USDA service personnel and have included it in this report as noted below. Obstacle Encountered:

- USDA prevented an internal and external review of its staff's efforts to provide optimum outreach and service to Hispanic/Latino farmers and ranchers as experienced by the researchers in their attempt to interview the local USDA service personnel through this study.

The following are a summary of barriers this study has identified:

USDA Barriers:

- USDA agencies, including: FSA, NRCS, NASS, RD, RMA and Cooperative Extension Service have not made adequate efforts in marketing their specific programs and services to the Hispanic/Latino farmers and ranchers.

- USDA NASS has not captured the true count of “all” Hispanic/Latino farmers and ranchers over the past 20 years.

Hispanic/Latino Farmer and Rancher Barriers:

- Hispanic/Latino farmers and ranchers have difficulty reading, writing and comprehending the English language.
- Hispanic/Latino farmers and ranchers have difficulty in comprehending agriculture policy and USDA program eligibility.
- Hispanic/Latino farmers and ranchers have difficulty in finding, understanding and receiving assistance from USDA programs and services.
- Most Hispanic/Latino farmers and ranchers have difficulty with expressing their needs and comprehending educational material presented at workshops, seminars and conferences in the English language, and in most cases, they also lack USDA cultural competency skills.
- Hispanic/Latino farmers and ranchers have difficulty in completing appropriate USDA program applications.
- Hispanic/Latino farmers and ranchers have a difficult time in accessing capital for purchasing farms and/or operation loans.
- Hispanic/Latino farmers have not acquired the skills to monitor plant, soil, insect, and pest conditions on their farms, and therefore, they have become dependent on the purchasing contract companies to determine the chemical application of fertilizers, pesticides, herbicides, etc., to their fields which may present economic and environmental hardships in the future.
- The FSA purchasing and operating loans take too long to process and close.
- Most Hispanic farmers and ranchers do not have knowledge of USDA FSA disaster programs and what records they must keep to apply or qualify for them.

- The Hispanic farmers and ranchers lack the understanding and importance of advocacy due to their lack of leadership opportunities and language barriers.
- Most Hispanic/Latino farmers and ranchers are not enrolled members of established farm organizations; therefore, do not have a voice on matters of farm policy and advocacy.
- Hispanic/Latino farmers and ranchers in Washington State are experiencing difficulties in maintaining a reliable and stable workforce and having to compete for any available farmworkers with larger farms who can afford to pay higher wages and ultimately, due to the stringent immigration policies that farmers are facing today.

A copy of the full report can be viewed and downloaded at: <http://www.centerforlatinofarmers.com/>

## **Session 4 F**

### **Track/Session: Alternative and Traditional Enterprises/Funding Opportunities**

#### **Funding Opportunities**

*Panelists: Denis Ebodaghe, USDA-National Institute of Food and Agriculture; James Hill, Sustainable Agriculture Research and Education Program, Marion Simon, Kentucky State University, Frankfort, KY*

Tips will be shared on where and how to apply for funds and get funded if you follow the directions outlined in the request for application or request for proposals. How to apply for solicited and unsolicited applications and how to access databases that store information on funding sources will be shared as well. Grant basics, overview and how to submit your application electronically will be discussed. Your goals and objectives when well-articulated can result in successfully getting your application funded.

## **Session 4 G**

### **Track/Session: Marketing Opportunities/Social Media**

## **Session 4 H**

## **Track/Session: Outreach to Underserved Communities/Management Strategies Part I**

### **New Faces on Old Places: Knowing your Small Farm Clientele**

*Jeff Fisher and Tony Nye, The Ohio State University*

#### **New Faces on Old Places: Knowing your Small Farm Clientele**

Fisher, J.C. and Nye, L.A. The Ohio State University Extension

fisher.7@osu.edu and nye.1@osu.edu

#### **Abstract**

The New and Small Farm College focuses on new and small farm landowners in Ohio seeking comprehensive farm ownership and management programming. As Extension educators, it is important to understand the demographics of clientele who participate in our programs.

The New and Small Farm College has three educational objectives:

1. To improve the economic development of small farm family-owned farms in Ohio.
2. To help small farm landowners and families diversify their opportunities into successful new enterprises and new markets.
3. To improve agricultural literacy among small farm landowners not actively involved in agricultural production.

The college consists of 20 hours of classroom time and a single-day tour of successful agricultural enterprises.

Results from pre-program and post-program surveys of 250 participants (mean age = 45.2 years) from 2009-2012 have indicated a high level of post secondary education (72%) and computer literacy (85%). An underserved population has been recognized in that 38% of participants are female and 71.2% of the participants indicated they were new clientele to Extension programming. The average farm size was 80.2 acres with average ownership of 12.7 years. While 53% indicated they did not initially have a plan for their farm, post-program surveys indicated 72.1% of the participants developed or changed their farm-use plan after attending these colleges. Pre -survey demographics are utilized to adjust curriculum for the motivations of the current audience with post-survey results used to design new curriculum and report impacts of the stated objectives.

#### **The Ohio State University Extension Small Farm Programs**

Landowners want to attain a greater understanding of production practices and requirements, economics of land use choices, assessment of personal and natural resources, marketing alternatives and the identification of assistance.

Small farms are also presented many challenges and circumstances that will affect their potential productivity and profitability.

Ohio State University Extension has developed a comprehensive farm ownership and management program based on increased information requests from new and small farm owners.

## **Bringing Small Farms to Life**

The agricultural landscape of today is very different than it was 20 years ago. Farms today are getting fewer in number and the ones that are left are growing in acreage. However there is a small group that is growing rapidly. The “Small Farmer” is a term used for individuals who are practicing agriculture on a very small amount of acreage, usually under 100 acres. These farmers are many times new to agriculture and are looking to begin a different lifestyle.

### **The Mission of Small Farm Programs:**

To provide a greater understanding of production practices, economics of land use choices, assessment of personal and natural resources, marketing alternatives, and the identification of sources of assistance.

Small Farm Program Objectives:

- \* To improve the economic development of small family-owned farms in Ohio.
- \* To help small farm landowners and families diversify their opportunities into successful new enterprises and new markets.
- \* To improve agricultural literacy among small farm landowners not actively involved in agricultural production.

### **Highlighted Education Programming:**

The New and Small Farm College: Started in 2005, the program focuses on new and small farm landowners in Ohio seeking comprehensive farm ownership and management programming. The college consists of 20 hours of classroom time and a single-day tour of various small farms to demonstrate successful agricultural enterprises.

The educational components of the Small Farm College consist of the following:

- Getting started in the planning process
- Sources of assistance
- Agricultural legal issues
- Insurance considerations for the farm
- Inventory of natural resources
- Financial and production record keeping
- Crops and horticulture production
- Animal Production
- Marketing

Small Farm Conferences and Trade Show: This program began in 2009 with the inaugural Small Farm Conference and Trade Show—”Opening Doors to Success” held at the Wilmington College Campus, Wilmington, Ohio. This program effort has grown to two conferences, adding the second conference, “Living the Small Farm Dream” previously held in Massillon, Ohio.

These intensive conferences are set up to provide small farmland owners the opportunity to explore options for their land use from over 35 different comprehensive seminars taught by Extension professionals and industry leaders on a wide variety of agricultural enterprises. Seminars focus in the areas of aquaculture, farm management, forages & pasture, livestock – exotic and traditional, horticulture – fruit and vegetables, natural resources, Sustainable Agriculture Research and Education (SARE), organic production, and marketing and much more. To date, more that 1000 small farm land owners and enthusiasts have attended these conferences.

### **Program Summaries:**

In 2012, two colleges were held in Ohio with 35 farms and 51 individuals represented, making the total participant count of this highly successful program at 568 individuals and 436 farms representing 52 Ohio Counties and one Indiana County since it began in 2005. Pre-program surveys in 2012 indicated participants represented 18 counties with 41.2% of the audience being female and 69.0% of the participants indicated they were new clientele to Extension programming. The average size of the farm participating was 75.9 acres (0 to 260 acres) with average ownership of 10.5 years. Post-program surveys indicated 72.1% of the participants developed or changed their farm use plan after attending these colleges. The participants rated the overall program a 9.05 out of a 10 point scale with 10 being best. One hundred percent of all participants responding would recommend this program to others and 96.5% felt the program met or exceeded their expectations.

In 2012, 158 small farmland owners and enthusiasts participated in one conference held in Wilmington, Ohio. Participants traveled from 42 different Ohio counties and two states to attend these events. Post-conference surveys indicated 42% of the attendees were women and another 2% were socially disadvantaged or minority farmers. From post-conference surveys, 85% indicated they learned something new from the attending the conference, 71.8% indicated they would change their management of their operation as a result of attending, and 64.1% of respondents indicated this was the first Extension Small Farm conference program they had ever attended. Average farm size represented at the conference was 49.5 acres. Surveys indicated that 55% of those responding considered themselves part-time operations and 27% were not yet engaged in a current farming operation. Fifty-five percent of those not yet engaged in a farming operation indicated they were planning to start their operation within the year.

As a result of attending the conference, 57.4% of the survey respondents indicated the value of this conference could impact their future bottom line anywhere from \$10 - \$35 per animal produced or \$10 - \$200 per acre.

### **Utilizing Pasture Walks to Provide Education and Outreach to Small Farmers and Ranchers**

*Mike Turpin, USDA / Natural Resources Conservation Service*

## **Utilizing Pasture Walks to Provide Education and Outreach to Small Farmers and Ranchers**

**Mike Turpin**  
**USDA/NRCS**  
**Natural Resources Specialist**  
**Monroe, LA**

Sometimes half-jokingly referred to as group therapy for graziers, organizations known as grazing networks, grazing alliances, or pasture walk groups are groups of farmers and ranchers who work together to increase their knowledge of forage management, pasture based production, and farm economics. Pasture Walk participants share their experiences and offer advice to one another, organize educational events around their common interests, and spend a little time socializing. These networks have been compared to the front porch of homes, where in a by-gone era, neighbors would gather to exchange news and information. Members of grazing networks usually find that what they learn from other farmers and ranchers is timely, practical, and profitable. They also find within the network a spirit of community and support that many find crucial to sustaining the life of family farms.

New Zealand farmers, especially dairy farmers, started forming grazing networks more than 40 years ago. These networks would become the foundation that would develop and promote intensive rotational grazing management techniques and would serve as templates for the grazing networks that have taken root in the US since the 1980s.

In 2005, Louisiana Natural Resources Conservation Service (NRCS) - Area 1, in partnership with several Soil and Water Conservation Districts and a core group of dedicated graziers with a passion for Grazing Lands Conservation, formed the North Central Louisiana Grazing Alliance. The Alliance's mission, as aptly stated by one of the founding members, is to "nudge our neighbors towards conservation". From humble beginnings, this Alliance would grow to become a strong and active grassroots organization that, along with other grazing groups across the state, would become the cornerstone that would rebuild and revitalize the Louisiana Grazing Lands Conservation Coalition.

The North Central Louisiana Grazing Alliance promotes a farmer to farmer, mutual self-help approach to learning through Pasture Walks and Field Days hosted by individuals on their grazing operations. The Walk agendas are flexible, enabling participants to share their experiences with one another. In many instances, Walk participants become both student and teacher. By providing the opportunity for small groups of graziers to join together for discussions of grazing lands conservation and forage management topics, the North Central Grazing Alliance is providing a relaxed atmosphere for the sharing of information and ideas.

Borrowing from principles such as constructivism from the disciplines of developmental psychology and educational theory the Pasture Walk concept allows participants to learn by doing rather than observing.

Constructivism is a learning theory whose roots can be traced back to the 18<sup>th</sup> century to the Italian philosopher Giambattista Vico. It is a theory that has components of philosophy, psychology, sociology, and education woven into its history. The contemporary philosophy of constructivism is grounded in the



works of Dewey, Piaget, Vygotsky, and Bruner and is based on the belief that each person constructs his or her own knowledge of the world through interaction with it.

Constructivism suggests that learning is an adaptive process. The learner's present state of knowledge is modified in response to a disequilibrium that comes from personal and social interactions. The resolution of the disequilibrium through assimilation and accommodation leads to an equilibrium state where new knowledge coheres with a particular experience and prior knowledge.

Two major strands of constructivism have evolved. These two strands are "social constructivism" and "cognitive constructivism". While each strand has its own emphasis and variations, they share several common characteristics. These characteristics are:

- All knowledge is constructed through a process of reflection and reorganization of the individual's current reality.
  - An individual's cognitive structures facilitate the learning process.
  - An individual's cognitive structures are constantly developing.

Whereas in traditional education, the role of the teacher is seen as that of a transmitter of knowledge, in the constructivist classroom a teacher's role changes significantly. The role of the teacher in the constructivist classroom is to act as a "guide". The teacher's job becomes to provide opportunities for learners to expand their knowledge in an active and engaged format.

Learners in this environment are active and not passive. They are encouraged to be independent thinkers and problem solvers. Learners are engaged in experiences that go beyond factual responses and provide opportunities to hypothesize, to analyze, to interpret, and to predict. Another essential component for learners is to communicate and collaborate with others, thus allowing for reinforcement and elaboration of ideas and concepts.

The typical Pasture Walk follows constructivism by providing an opportunity for active, meaningful learning. The group dynamics that occur during the Walk enable a constant flow of conversation and exchange of ideas that increase engagement and attention of the participants. When Walk participants become both student and teacher, the participant achieves the "guide" position advocated by classroom practitioners of constructivism.

Targeting specific groups has proven successful in reaching nontraditional audiences. The Annual Ladies Only Pasture Walk and The Heifer Project International Pasture Walk target groups that may not be served by traditional outreach methods. To date, The North Central Louisiana Grazing Alliance has held 35 Pasture Walks attended by 1,095 participants.

Utilizing the Pasture Walk format, the Alliance, NRCS- Area 1, Monroe City Schools, and several Partner Organizations cosponsored *The Water Festival*. This event provided water quality and conservation education to 480 fourth grade students through fun-filled, hands-on activities. All of the students live in a high poverty, inner city environment and many are considered "at-risk"; likely to exhibit low academic performance and have a high dropout rate. *The Water Festival* was the first

exposure for many of these students to conservation education and the role of healthy grass lands in preserving and protecting water quality.

## **Connecting Socially Disadvantaged Farmers and Forest Landowners with Resources**

*Whitaker Small Farm Group, Charles Whitaker, Garner, NC*

### **“Connecting Socially Disadvantaged Farmers and Forest Landowners to Resources”**

**Whitaker Small Farm Group, Charles Whitaker, Garner, NC**

#### **Introduction**

Whitaker Small Farm Group began with hands-on training for limited resource, women and minority farmers and forest landowners. Farmer participants received hands on training in various agricultural enterprises to include permaculture, greenhouse operations, hydroponics, alternative raised bed gardening and mushroom growing along with training in the economics of high tunnel growing, niche marketing, farm cooperatives and farm management. We partnered with local farm cooperatives, North Carolina A&T State University (NCA&T SU), Leonard C. Cooper International Trade Center, NC Cooperative Extension Service, USDA, state and local non-governmental agencies. “Connecting Socially Disadvantaged Farmers and Forest Landowners to Resources” is year two of the original project with an overarching goal of reaching out and bringing together farmers who are outside of the USDA database and mainstream. These are producers who do not visit the USDA offices and do not request assistance partially due to lack of exposure to available resources, historical apprehensions and fears. Whitaker Small Farm Group’s efforts are specifically targeted to those who have not benefited from available programs, bringing them into a conference setting of shared learning on available USDA, other government programs and applicable USDA lawsuits.

The “Hands-on Training” and conference participants have been from 41 targeted counties in Central and Eastern North Carolina. Utilizing grassroots outreach efforts, we rely upon local clergy, community groups, word-of-mouth networking, one-on-one conversations with farmers and farm groups, interest meetings, focus groups along with radio, newspaper, our own newsletter, and magazine advertisement. Participant remarks as to the value of the conferences organized by Whitaker Small Farm Group September 2012, 6th National Small Farm Conference include “You are a life saver”, “This information needs to be out there for all of us” and “When will you be back again” just to offer a few. Many farmers speak to the benefit of networking and hearing from one another which they state does not happen enough. Our goal is to do the most good for limited resource, minority and women farm and forest landowners, and to nourish the understanding across diverse groups of the wealth of resources available to them. Once there is an understanding that help is available, our mission is then to facilitate access to resources.

We currently are closing out this fiscal year with a major conference to be held September 10, at the University of North Carolina at Pembroke in Pembroke, NC. We will begin this next fiscal year with a beginning farmer training project in partnership with NCA&T SU in Greensboro, NC, where we will bring 12 intern farmers onto the university’s farm and under the direction of the farm superintendent, they will receive hands-on training in various aspects of farm operations and management.

#### **Organizational Strategies of Outreach**

Target Audience Identified:

Our target audience was first defined by the requirements of the grant-socially disadvantaged, women and minority farm and forest landowners. We then took a look at county demographics and chose the counties we wanted to serve as written in our

grant request. The number of counties served as indicated via participant registration has grown from the original 29 listed in the grant to 41.

### Organization and Key Partners

Partnership with USDA, State, local government and non-governmental organizations is key to identifying potential participants. A barrier to this effort has been outdated databases, and getting correct addresses for the use of direct mailing is essential to reaching Whitaker Small Farm Group's potential participants.

Forging relationships in the communities require a concerted effort at meeting them in their "home" and selling the vision, the mission and the plan. Establishing a working relationship with stakeholders opens up access to the communities. Fostering and creating support groups along the way is also a vital aspect of outreach management. We have assisted with the formation of a farm cooperative, established a demonstration farm training site in the community and have begun a new farm cooperative. Our goal is to establish that we are a part of the community and are here to not only deliver a product, but to also foster sustainability.

### Organization and Partnership into Action:

"Grassroots" getting the message out to the community is what works. Using our relationships as entrée into the community and we have relied upon trainees getting the word out, focus groups with community leaders, partnering with community organizations, advertisement in both newspaper and radio, our own newsletter, links to faith-based community members and delivering a viable product. The decision to use outreach conferences came from focus group meetings with trainees that shared access to many USDA and other agency program representatives were limited by travel and availability. The decision to bring as many program reps under one roof was a simple one. Being responsive to the needs identified by participants is key, thus the follow ups with telephone calls, community visits, small and large group meetings, enlisting support of local leaders, outreach staff who know the community are key to successful participation. We have had low participation numbers and though discouraging, it did not stop the efforts of getting the word out. Our programs in hands-on activities have continued while conducting outreach conferences. We also took a group of about 35 participants on a three day farm enterprise tour which was met with a flurry of excitement and satisfaction. The request for more learning activities come in daily and for us this means that the good word is getting out. At this 6th National Small Farm Conference, the Whitaker Small Farm Group has a product to deliver that will help the farm and forest landowner.

### Looking Towards the Future:

We are closing out the year with the major conference mentioned earlier. In the third year of our grant process, we have a major farm intern project that includes hands on training to be held at NC A&T State University in Greensboro, NC on the site of the University farm under the supervision of the farm superintendent. This new grant project is in direct response to the identified need of bringing more young people who are currently on farms and assist them in developing their knowledge of farm enterprises, encouraging them to remain in farming and helping them establish viable farms. Whitaker Small Farm Group plans to rotate about 16 young farmers through a series of hands-on training activities on the University farm. During this next fiscal year, the project will expand from one farm demonstration site to two sites with plans to bring hands-on training into Jamesville, NC, a small town further northeast than our current demonstration farm which is in Faison, NC. We are happy to present our outreach efforts, and to share the success of the project. We will compile the statistics for the entire year in order to look at our impact. Our mission continues to be to foster sustainable agriculture enterprises in the communities that we serve via outreach and training services.

## **Session 4 I**

**Track/Session: Program Planning and Implementation/Building Capacity**

## **Session 4 J**

**Track/Session: Research and Extension Priorities/Managing Agricultural Risks Part I**

### **Risk Management Needs of Historically Underserved Farmers**

*H.L. Goodwin, Jr., Sandra Martini, L. Paul Goeringer, and Ron Rainey, University of Arkansas Cooperative Extension Service, Fayetteville, AR*

### **Risk Management Needs of Historically Underserved Farmers**

**H.L. Goodwin, Jr., Sandra Martini, L. Paul Goeringer, and Ron Rainey**

**University of Arkansas Cooperative Extension Service, Fayetteville, AR**

The diverse nature of Southern agriculture and agricultural producers pose interesting and non-trivial challenges for risk management education. Growers are actively seeking assistance to help them navigate through today's challenging economic environment. Agricultural production has evolved over the past century from operations that were predominantly subsistence-based or sharecropped to predominantly large-scale family-owned corporations (in the case of traditional row crop farms); family-owned independent contract farming (in the case of poultry and swine, often including cow-calf production); and small and large-scale specialty farms with mixed-use operations.

Increasing ethnic diversity of farm operators as well as the growth of female operators adds additional complexity to risk management education efforts geared toward Southern agricultural producers. Risk management education and outreach efforts must be intentional in engaging these diverse audiences.

Different groups of producers may respond to risk in different ways. Research conducted at the University of Arkansas by Ahrendsen and Dixon focused on loan performance of various producers related to Farm Service Agency debt retirement. They found non-white farmers more likely to exit farming due to loan non-performance than other groups of farmers but less likely to exit for other reasons. Young and beginning farmers (YBRF) were similar with respect to loan non-performance but differed in their exit behavior and often lack capital and experience, generally have a smaller scale of production making profitability more challenging, and often face higher land costs.

### **Risk Colloquia**

The foregoing factors emphasize the need to develop programs targeted at effectively reaching special emphasis communities of producers to increase their capacity to stay in agriculture.

To identify the risk perceptions and resultant producer behaviors, SRMEC convened a series of risk colloquia geared toward special emphasis communities of producers identified by USDA. Participants were recruited from networks of leaders in the African American (AA), Native American (NA), Young and Beginning Farmers and Ranchers in conjunction with state Farm Bureau leaders (YBFR) and Women in Agriculture (Women) from across the South. In total there were 75 producers that participated in the colloquia representing livestock, forage, grain, specialty crop and diversified producers with operations ranging from 5 acres to 3,000+ acres. Discussions were lively, open and focused and helped to foster connections among those present. The African American colloquium was first and was used as a focus group to fine-tune the following colloquia. As such, it will be repeated in full measure. Results of the colloquia will be used by the SRMEC Advisory Board to help set grant priorities in future years. Colloquia are scheduled in the Fall of 2012 for African American (repeat) and winter 2013 for specialty crop producers.

### **Risk Colloquia Sessions**

The primary activity of the one-day risk colloquia format consisted of sessions that were conducted using a technique referred to as “Bar Camps” and facilitated by trained SRMEC staff. The Bar Camps were comprised of three color-coded groupings with participants randomized in each; nine different groups were taken through the issue

*Identification* process. After each Bar Camp, participants grouped issues into eight broad categories. Each participant voted for their first, second and third most important issues. The groups rejoined to take a post knowledge survey and conduct a composite voting session in which participants assessed the combined top ten issues identified and re-voted in the same manner as previously noted. Results are shown in Figures 1-4.

### **Post-session Survey – Select Results**

As risk management educators, Extension professionals are concerned not only with facts and opinions related to risk management, but also with the sources of information producers currently use to guide their decision-making. All are aware of the increasing role crop consultants, financial planners and tax specialists are playing in production agriculture. But results of the post-session surveys highlight what we believe are some emerging and even accelerating trends that strike at the core of Extension’s primary educational charge – provision of information. In light of this, results of the four post-session survey questions addressing sources of information are presented in Figures 5-8. In brief, these questions asked where producers get information on financial issues, production management decisions, risk management and availability of government programs. They are instructive and thought provoking. The primary source of information for participants in the risk colloquia, selected as representative agricultural leaders of their respective groups, are as follows: (1) Financial Issues - Other producers, bankers, Tribal personnel and Farm Bureau; (2) Production Decisions - other producers and Extension Fact Sheets; (3) Risk Management – Other producers, Farm Bureau and Women in Ag; and (4) Government Programs – NRCS and websites.

### **Proposed Response to Risk Colloquia Findings**

Risk colloquia results indicate education and training have the potential to effectively address key risk issues identified in the colloquia, provide information in the four areas polled in the post-surveys and provide a way for SRMEC and the Southern Extension Committees to cooperatively partner to do so.

The order in which these top priority areas are addressed and the method in which they are addressed will bear on the effectiveness of educational outreach to historically underserved farmers, and will likely impact their willingness to further pursue educational and outreach opportunities for producers.

-Ahrendsen and Dixon

**Figure 1. Summary of Final Prioritization of Key Risk Issues Facing Tribal Producers**

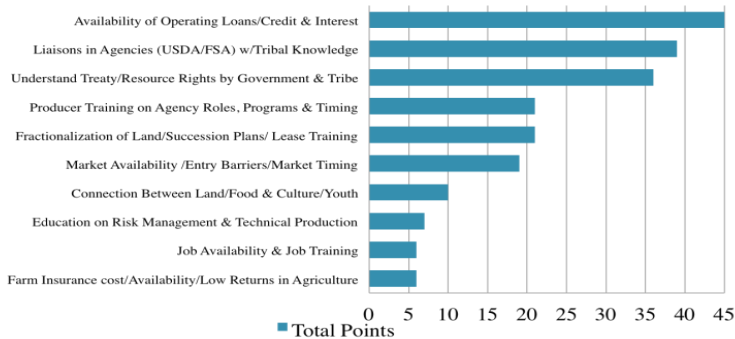

**Figure 2. Summary of Final Prioritization of Key Risk Issues Facing Young and Beginning Farmers**

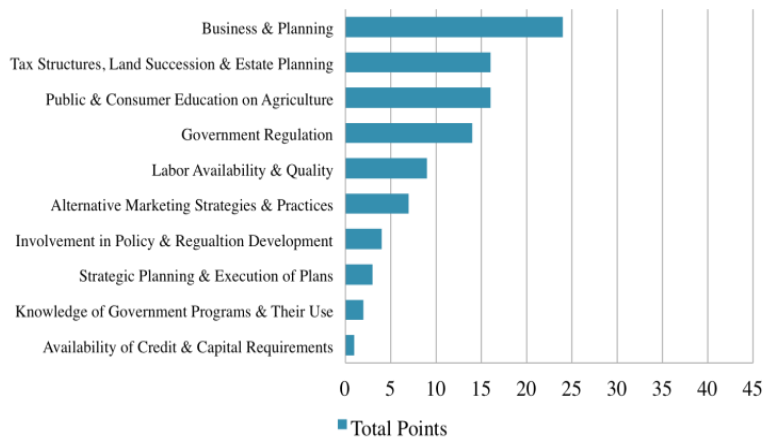

**Figure 3. Summary of Final Prioritization of Key Risk Issues Facing Women Producers**

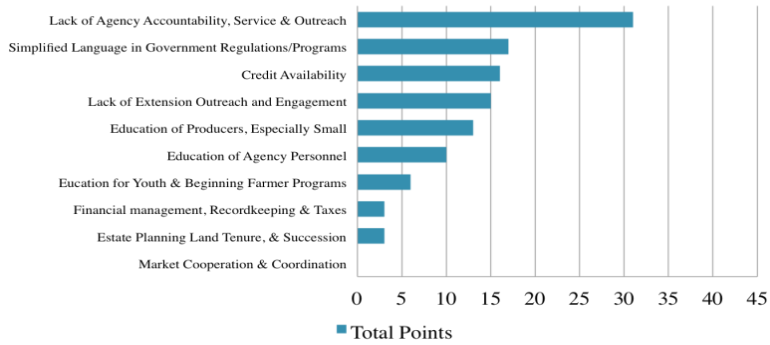

**Figure 4. Summary of Final Prioritization of Key Risk Issues Facing Hispanic Producers**

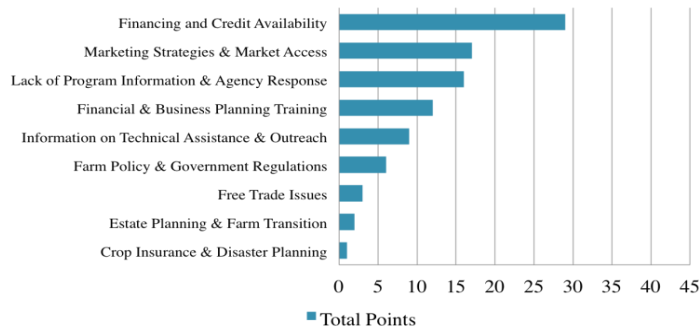

**Figure 5. Where do you get information on financial issues for your operation?**

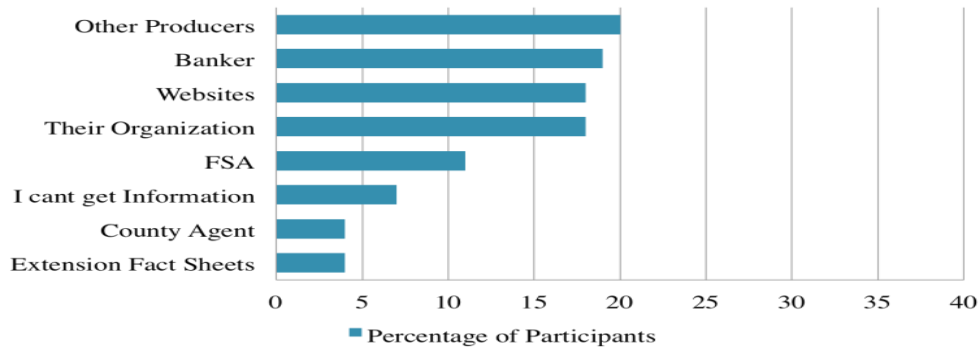

**Figure 6. Where do you get information on production management decisions?**

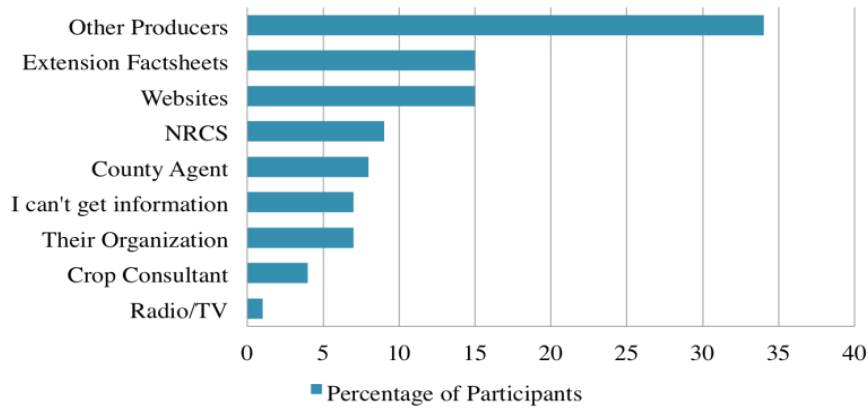

**Figure 7. Where do you get information on risk management decisions?**

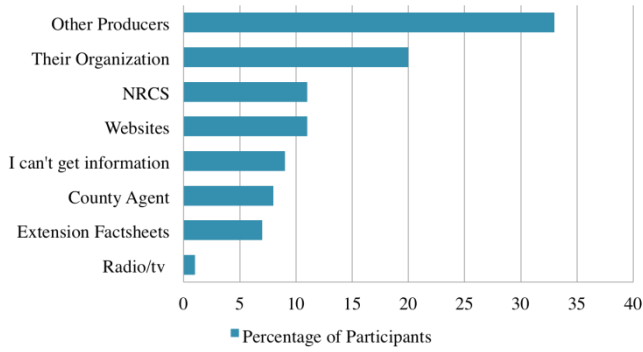

**Figure 8. Where do you get information on eligibility for government agriculture programs?**

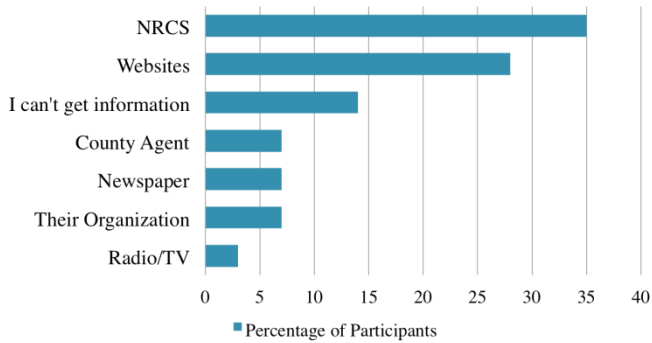



## **The Role of Small Farms in Controlling Runaway Food Issues and Its Environmental Impacts**

*Ali Mohamed and Denis Ebodaghe, USDA / National Institute of Food and Agriculture*

### The Role of Small Farms in Controlling Runaway Food Issues and Its Environmental Impacts

*Authors: Ali Mohamed and Denis Ebodaghe, USDA / National Institute of Food and Agriculture*

The runaway food system may be contributing to problems from obesity to environmental pollution and is undermining our ability to feed future generations. The choices of rich versus poor, industrial versus family and modern versus antiquated are all false dichotomies. Obesity rates tripled in the past 30 years, a trend that means, for the first time in our history, American children may face a shorter expected lifespan than their parents. Large Industrial agribusiness corporations have gained runaway control of our food systems and to take them back. In this presentation, the role of small farms and other concepts such as from farm to school program and know your farmer, know your food will be discussed. In addition, the environmental and economic impact of current food system will be explored and alternative systems that involve small farms will be presented. Small farms play a vital role in filling voids in food supply. Limiting the distance travelled in getting food from farm to table will go a long way towards reducing runaway food issues. Close proximity from farm to table reduces cost associated with storage, refrigeration, contamination and risk of spoilage. All these and a whole lot more will be discussed.

### **USDA Statements on Sustainable Agricultural Development**

#### **The global food crisis**

*“The problem is not the production of food ... it is the economic, social and political model of the world. The capitalist model is in crisis.”*

The term sustainable agriculture, as defined in the 1990 and 1977 “Farm Bills”,<sup>2</sup> means an integrated system of plant and animal production practices having a site-specific application that will, over the long term:

- Satisfy human food and fiber needs;
- Enhance environmental quality and the natural resource base upon which the agricultural economy depends;
- Make the most efficient use of nonrenewable resources and on-farm resources and integrate, where appropriate, natural biological cycles and controls;
- Sustain the economic viability of farm operations; and
- Enhance the quality of life for farmers and society as a whole.

USDA reiterated these principles in its 2010 *Consensus Statement on Sustainability*:

The U.S. Department of Agriculture is committed to working with partners and stakeholders toward sustainability of diverse agricultural, forest and range systems. USDA seeks to balance the goals of: 1) satisfying human needs; 2) enhancing environmental quality, the resource base, and ecosystem services; 3) sustaining the economic viability of agriculture; and 4) enhancing the quality of life for farmers, ranchers, forest managers, workers and society as a whole. USDA integrates these goals into its policies and programs, particularly through interagency collaboration, partnership and outreach at both domestic and international levels.

USDA encourages the development and adoption of place-and-scale-appropriate management, production, distribution, and information systems that advance continuous, integrated progress toward all of these goals across landscapes, supply chains and markets. USDA also supports the principles of “reduce, reuse, and recycle” in relation to efficient product handling,

---

<sup>2</sup> Food, Agriculture, Conservation, and Trade Act of 1990 (FACTA), Public Law 101-624. Title XVI, Subtitle A, Section 1603, GPO, Washington, D.C., 1990 NAL Call#KF1692.A31 1990; and section 1404(17) of the National Agricultural Research, Extension, and Teaching Policy Act of 1977 (7 U.S.C. 3103(17)).

processing, transportation, packaging, trade, consumption and waste management.

### ***The runaway industrial food system***

There is a relationship between food and sustainability. Such relation can be defined by 3 facts; the first is, food is fundamental to sustainability. Food has been and continues to operate in the shadows of energy, LEED construction, and other physical aspects of sustainability. In actuality, we cannot have sustainability without addressing food and agriculture and natural resources. Second fact is we cannot deal with food issues in isolation; there is a positive and necessary synergy between other aspects of sustainability and food and agriculture issues. Finally, the agriculture communities, Federal and State agencies and institutions should incorporate food, agriculture and nutrition in their effort to develop sustainable communities.

Food production clearly impacts land use and consequently carbon cycles, biogeochemical cycles and ecosystem health as well as public health and economic issues on both a local and global scale. Water use patterns are also driven by food production. With significant changes in climate, these water-food relationships have bred tensions around the world that will continue to grow as the resource becomes scarcer. As agriculture becomes more mechanized and energy-intensive, food production becomes an energy sink as well.

Furthermore, globalisation affects agricultural production and trade and has consequences for the sustainability of both conventional and organic agriculture. During the last decades, agricultural production and yields have been increasing along with global fertilizer and pesticide consumption. This development has been especially pronounced in the industrialized countries and some developing countries such as China, where cereal yields have increased a remarkable 2-fold and 4.5-fold respectively since 1961.

Such agricultural development has contributed to environmental problems such as and global warming, reductions in biodiversity and soil degradation. Furthermore, pollution of surface and groundwater with nitrates and pesticides

remains a problem of most industrialized countries and will presumably become a growing problem of developing countries.

Organic farming offers a potentially more sustainable production. Organic farming is practiced in approximately 100 countries of the world and the area is increasing. European countries have the highest percentage of land under organic management, but vast areas under organic management exist in e.g. Australia and Argentina. Europe and North America represents the major markets for certified organic products, accounting for roughly 97 percent of global revenues.

In the United States, there are significant development and increase in organic agriculture as depicted in table 1.

Table1. U.S. Organic Food Sales

In the U.S., food production receives an enormous amount of public funding, including \$248.6 billion in the 2002 Farm Bill. By most accounts, these public funds are not well spent,

leading to tremendous inefficiency, corruption and ill health throughout the food system.

Wastefulness in U.S. agricultural trade and subsidies impacts international food markets and often

negatively affects developing countries by disrupting local and regional food systems and by undermining the economic viability of agricultural enterprises.

Finally, food is central to culture: it gives people a sense of place, an experience of cultural diversity, and an identity. Globalization and industrialization of food production and the development of a runaway food system continually seeks to consolidate and homogenize global markets undermines the diversity of agriculture, food enterprises, and cuisine and therefore culture and sovereignty.

	2005	2006	2007	2008
Organic Food Sales				
Growth Rate*	---	20.9%	18.5%	15.8%
Total U.S. Food Sales				
Organic				
* Increase in sales, year 1 to year 2 (e.g. 2007 to 2008)				
** Organic food as a percent of total U.S. food sales				

Another negative consequence of the runaway food system is an unprecedented increase in the transportation and energy consumption involved in the global food system. The increasing average distance food travels from farm to fork must be stemmed through comprehensive approaches that begin to build a more sustainable food system.

One of the answers to such challenges is the establishment of food communities and encourages localization of food production. The major difference between globalization and local food production is depicted in table 2.

Disconnect between food consumption and food production in the U.S. is still growing. One of the major factors is the transformation of American culture from a participant effort to a consumer-based interaction. Consumers are concerned with price and convenience, and the industrial food system may meet such need. However, the ecological, economic and public health impacts of this runaway food system have reached critical point with significant negative impact on a domestic and global obesity pandemic, climate change, and environment and natural resources. Such industrial

<b>Table 2</b>	
<b>GLOBAL</b>	<b>LOCAL</b>
Market economy	Moral economy
An economics of price	An economic sociology of quality
TNCs dominating	Independent artisan producers prevailing
Corporate profits	Community well-being
Intensification	Extensification
Large-scale production	Small-scale production
Industrial models	“Natural” models
Monoculture	Bio-diversity
Resource consumption and degradation	Resource protection and regeneration
Relations across distance	Relations of proximity

agribusiness production system is a major driver of unsustainability and a declining quality of life.

**Actions you can take to change the food system!**

- Learn how to cook using whole or less processed foods.
- Shop at the Root Cellar, Farmers’ Market (Check out the Veggie Patch!) or City Market or other farmers’ markets.
- Plant a garden and experience the wonder of growing life.
- Learn how to freeze, can and store seasonal fruits and vegetables produced in your local area.
- Eat “local” fast foods at Main Squeeze, Uprise Bakery, Chipotle and other restaurants.
- Ask your supermarket manager to stock locally produced fruits and vegetables in season
- Read Fast Food Nation or The Omnivore’s Dilemma
- Help create links between your school food service (dorms, greek houses) and local farmers. (Tell Campus Dining you like the apples!)
- Ask your waitress for specials featuring locally, sustainably produced food.
- Become a member of a Community Supported Agriculture (CSA) farm.

Commodities across space	Communities in place
Big structures	Voluntary actors
Technocratic rules	Democratic participation
Homogenization of foods	Regional palates
Attributes associated with “Global” and “Local”	
Sources: Hinriches et al., 1998; Lang, 1999.	

**Our Responsibilities**

- ✓ Good, clean and fair food is going to take cooperation
- ✓ Farmers see other farmers as cooperators and not competitors

- ✓ Eaters see themselves as more than consumers – as community members, as citizens, as workers, as participants
- ✓ Concern ourselves with structure (what kind of relationships are we creating?) rather than scale (how big is too big?)

### What do we get?

- **Better Nutrition:** Increased consumption of nutrient dense foods coupled with a decrease in nutrition-related diseases like diabetes and obesity
- **Improved Local Economy:** Increased number of viable farms, processors and stores contributing to the local economy
- **Self-reliant, Food-Secure Community:** Everyone, regardless of resources, gets fresh, flavorful, healthy food at all times.
- **Strengthened community relationships:** Proximity is powerful – one can see the needs, the hopes, the opportunities with our family, friends, neighbors and community members.

**Global Challenges to the Food System:** By 2050 the world's population is expected to reach 9.1 billion people, and 70 percent of this population will live in urban areas. Much of this population growth is taking place in developing countries, where income levels are rapidly growing, changing dietary choices and agricultural demand. In order to meet this demand, food production will need to increase (net of food used for biofuels) by 70 percent. Here are some expected issues which will face:

- Dramatic price fluctuations in food prices, which disproportionately affects the developing world
- Availability of Natural Resources (land, water, and genetic diversity) (FAO)
- Availability of arable land (FAO)
- Water (FAO)
- Biodiversity (FAO)
- Changing diets (FAO)
- Yield Curb (Economist)
- Climate Change (personal knowledge from work experience at the ICARDA Genetic Resources Unit)

## **Session 4 K**

**Track/Session: Outreach to Underserved Communities/Outreach Effectiveness at USDA-Natural Resources Conservation Service**

## **Session 4 L**

**Track/Session: Outreach to Underserved Communities/An Overview of the Office of Advocacy and Outreach**

*Panelists: Dexter L. Pearson, Associate Director, USDA Office of Advocacy and Outreach and Karla Martin, USDA Office of Advocacy and Outreach*

## **Session 4 M**

**Track/Session: Outreach to Underserved Communities-Tools and Practices**

**U.S. Forest Service – Climate Change and Agroforestry: Tools and Practices**

*Panelists: Richard Straight, David Cleaves, Cheryl Bailey, USDA National Agroforestry Center & U.S. Forest Service*

## **Session 4 N**

**Track/Session: Outreach to Underserved Communities/Risk Management Agency's Farm Safety Net**

## **Session 4 O**

**Track/Session: Outreach to Underserved Communities/2012 Farm Bill**



**From Plow to Pen: Embracing a Coalition-Based Approach to Achieve Equity for Historically Underserved Farm Communities in the 2012 Farm Bill Negotiations**

*Panelists: Tracy Lloyd McCurty and Lorette Picciano, Rural Coalition, Savonala Horne, Land Loss Prevention Project, Rudy Arrendondo, National Latino Farmers and Ranchers Trade Association, and John Zippert, Federation of Southern Cooperatives*

**From Plow to Pen: Embracing a Coalition-Based Approach to Achieve Equity for Historically Underserved Farm Communities in the 2012 Farm Bill**

**Lorette Picciano,**

**Rural Coalition/Rural Coalición, Washington, DC**

**Savonala Horne**

**North Carolina Association of Black Lawyers and Land Loss Prevention Project,  
Durham, NC**

**John Zippert, Federation of Southern Cooperatives/Land Assistance Fund  
Rural Training & Research Center, Epes, AL**

**Introduction**

Key organizations with long experience in this debate will lead the discussion on enhancing grassroots focused strategies and to develop a concrete agenda for the future to influence this policy to advance rather than hinder community-based agricultural food systems in rural communities. This 2-hour workshop will focus on the distinct challenges of the 2012 Farm Bill as well as the development of concrete recommendations on process, substance and strategies for the 2012 Farm Bill Debate.

**Status of 2012 Farm Bill Negotiations**

Congress will be in session for less than a month before the end of this fiscal year. This is the last chance for Congress to act on the Farm Bill legislation before it expires at the end of September.

The Rural Coalition and other partner organizations and allies participating in the “Getting Our Act Together” (GOAT) on the farm bill process have been advocating to retain the gains made in the 2008 Farm Bill for socially disadvantaged and beginning producers, farmworkers, Indian tribes, and in support of nutrition and local food programs. We understand there is a need to work quickly to fill the gap left by the 2008 Farm Bill. Currently, many farmers across the United States are suffering from severe drought, desperately needing disaster assistance that has been included in the drafts of the new Farm Bill. Also, crucial programs for beginning and socially disadvantaged farmers and ranchers, rural and small business development, renewable energy, local food, and organic and specialty crop research will be left with no funding for FY 2013 if the Farm Bill is allowed to expire.

There are several ways in which Congress can act on this legislation before the end of the fiscal year. The Senate has passed its 2012 Farm Bill but the House has failed to continue the work completed over a month ago in the House Agriculture Committee by bringing the bill to the full House of Representatives for a vote. Congress could also extend the 2008 Farm Bill through sometime in FY 2013, which begins on October 1, 2012. The 2008 Farm Bill funding supporting new farmers, supply chains for local food, entrepreneurial development, new energy sources, new markets, and high impact research should be extended, along with adequate funding for nutrition programs should be directly addressed and assured. This type of extension is the only extension that adequately addresses the critical issues for the constituencies we represent and for our farm bill programs.

### **Status of the 2501 Outreach and Assistance to Socially Disadvantaged Farmers and Ranchers**

In May 2012, the United States Senate Committee on Agriculture, Nutrition and Forestry’s draft of the Farm Bill removed mandatory funding for the 2501 Outreach and Assistance for Socially Disadvantaged Farmers and Ranchers Program (OASDFR) — the only Farm Bill program dedicated to addressing the needs of African-American, American-Indian, Asian-American and Latino farmers and ranchers and provides critical resources, outreach and technical assistance to groups that have been historically underserved by federal programs. Moreover, in an amendment that was offered in the Agriculture Committee’s mark up of the Farm Bill that was subsequently voted out of the Committee, \$5 million in annual mandatory funding (totaling \$25 million over the five years of the Farm Bill) was returned to the OASDFR account and the eligibility requirements were expanded to include veteran farmers and ranchers.

In July 2012, the United States House Committee on Agriculture’s draft of the Farm Bill provided \$10 million in annual mandatory funding for the OASDFR Program (totaling \$50 million over the five years of the Farm Bill) and similar to the Senate version, the eligibility requirements were expanded to include veteran farmers and ranchers. The House version of the Farm Bill has yet to be brought before the Full House for a vote.

## **History of the 2501 Outreach and Assistance to Socially Disadvantaged Farmers and Rancher<sup>1</sup>**

After the 1982 US Commission on Civil Rights report, the Federation of Southern Cooperatives/Land Assistance Fund (Federation), and a coalition composed of other Community-Based Organizations (CBOs), 1890 Land Grant Colleges and civil rights organizations, pressured the Reagan Administration to respond. Using its “Salary and Expense” (S&E) budget, the USDA set up a “Small Farmer Technical Assistance Program” in 1984 and provided between \$1 to \$2 million annually to the program.

In 1985, the coalition organized around the Farm Bill and the 1987 Agriculture Credit Act to include civil rights and targeted provisions for Farmers Home Administration (FmHA) farm ownership loans, based on percentage of minorities in rural counties. This included sales of FmHA inventory lands. The program has targeted over \$175 million in loans to several thousand African-American and other farmers of color over the past ten years.

Between 1987-1990, the Federation held over 250 grassroots meetings with farmers. Other groups held similar meetings to develop the “Minority Farmers Rights Act”. Provisions of the bill included a \$10 million outreach and education program, targeting of FmHA Ownership and Operating Loans, a registry of minority farmers, more employment and participation by people of color on USDA staff and farmer committees, reports on civil rights performance and equal access to all USDA programs. The Federation also established a coalition of more than 120 community groups and individuals, including 1890 Land Grants, civil rights leaders, churches, labor and consumer groups to support the “Minority Farmers Rights Act”. Among the participants in this coalition were: National Farmers Union, National Family Farm Coalition, Rural Coalition/Coalición Rural, North Carolina Association of Black Attorneys Land Loss Project, Intertribal Agriculture Council, Arkansas Land and Farm Development Corporation, National Council of La Raza, National Association of Historically Black Land Grant Colleges, NAACP, SCLC, National Black Leadership Roundtable, AFL-CIO and many others.

Congressman Mike Espy of Mississippi and Senator Wyche Fowler of Georgia were co-sponsors of this historic “minority farmers rights section” of the 1990 farm bill which passed and included authorization of \$10 million for an “Outreach and Technical Assistance Program for Socially Disadvantaged Farmers and Ranchers”, some targeting of FmHA Direct and Guaranteed Farm Operating Loans to farmers of color and required reports on the civil rights performance of USDA agencies.

This created the legislative basis and legal authorization for outreach programs to farmers of color. However, no funds were appropriated for implementation of Section 2501 in Fiscal Years 1991 and 1992. The first funds, \$1 million, were appropriated in FY 1993, which were distributed as planning grants to 21 CBOs, 1890 Land Grants and Tribal colleges. In FY 1994, \$3 million were appropriated. In FY 1995 \$2.9 million were appropriated coupled with Small Farmer Technical Assistance Programs and S&E funds so that the program received approximately \$4 to \$5 million per year, at its highest level. After FY 1995 and USDA reorganization, the S&E funds for the Small Farmer Technical Assistance program were phased out.

In FY 1996 & FY 1997 appropriations for 2501 were reduced to \$1 million. However, Secretary Glickman approved \$4.5 million for the outreach program from the Fund for Rural America in FY 1997 and Congress appropriated \$3 million for FY 1999.

The 2008 Farm Bill, nearly a decade later, finally provided \$75 million in mandatory funding over four years for the 2501 OASDFR Program along with other equity provisions that address institutional barriers that have prevented socially disadvantaged producers from fully participating in USDA programs and services.

### 2501 Farmer Success Story: Alabama Association of Cooperatives

The Alabama State Association of Cooperatives (ASAC) is the Alabama affiliate of the Federation of Southern Cooperatives and has been engaged in technical assistance and support for cooperatives and credit unions in the state since 1970. A significant part of our mission is outreach, technical assistance, education, resource development and other services to the African-American farmers, landowners, and rural community residents who comprise the membership of these cooperatives, credit unions and other self-help non-profit associations.

The 2501 Program is the foundation for much of the assistance we provide to farmers and other rural residents in the areas of record-keeping, credit, conservation, cooperative development and other technical services.

Alabama State Association of Cooperatives (ASAC) helps remaining African-American family farmers and landholders fully utilize their land base. African-American family farmers and landholders in eight western Alabama Black Belt counties and four adjoining counties who were historically underserved and discriminated against long ago lost faith in the US Department of Agriculture.

With support from the Outreach and Assistance Program for Socially Disadvantaged Farmers and Ranchers, the Alabama State Association of Cooperatives (ASAC) is reconnecting producers in the Black Belt counties of Pickens, Sumter, Choctaw, Greene, Hale, Marengo, Perry, and Wilcox; the four (4) adjoining counties, Clark, Monroe, Washington and Dallas with the offices, programs and services of USDA. As a result, producers are more likely to use these programs and services to retain, expand and fully utilize their land base, and are building cooperatives, housing and other ventures that expand the economic base of their communities.

### **North Carolina Association of Black Lawyers Land Loss Prevention Project**

The 2501 Program grant afforded the Land Loss Prevention Project (LLPP), the opportunity to connect with African-American farming communities in North Carolina, South Carolina, and Michigan. By offering workshops to potential *Pigford II* claimants, we were also able to share information about the

various USDA services available to these communities.

Due to outreach in North Carolina, LLPP were able to identify thousands of African-American farmers who appear to have erroneously been denied eligibility to file claims. However, our efforts created an opportunity for a more promising outcome for these farmers. In part due to the numerous shortcomings of the *Pigford* claims process, LLPP observed a lingering perception of limited access to USDA programs and services in these communities.

While county level offices and staff could be available, the community believes these services are not fully accessible which undermines their consumption of the full range of services that are offered. By creatively and consistently engaging African-American farming communities which continue to perceive gaps in USDA services at the local level, the 2501 program can truly eliminate the legacy of discrimination.

Through surveying current and prospective Latino farmers in North Carolina, LLPP identified a substantial technological divide in accessing information about USDA programs and services. For example, some USDA website links that purportedly connect to resources in Spanish actually connect to English-only resources.

### **Effective Grassroots Collaborations, Processes and Strategies to Effectuate Substantive Policy Changes**

- Farm and Food Policy Development – Through diverse processes and collaborations, build unified support on a broad set of Farm Bill policy initiatives that advance a food system rooted in equity and sustainability.
  - Farm and Food Policy Diversity Initiative (DI): In 2006-08, the DI led by Savonala Horne and coordinated by Rural Coalition supported the efforts of its partners to secure more than 30 sections of policy in the 2008 Farm Bill.
  - GOAT
  - Kellogg Equity Cluster

- Policy Education/Civic Engagement – Educate policy makers and decision makers on the needs of diverse farmers and farmworkers and policy alternatives that could meet those needs through testimony, comments, sign-on letters, and grassroots action.
- Community Leadership Development – Mentor diverse leaders rooted in our member communities in the policies and processes of national and local agriculture policy using an inclusive leadership approach that shares policy knowledge and history developed over the past decades and prepares future leaders to move the policy debate forward.
- Secure Structural Change at USDA and Equity in the Food and Farm System –Continue efforts to secure redress for producers who have suffered discrimination and assure equity for all producers in accessing USDA programs. Complete implementation of the equity provisions of the 2008 Farm Bill, including the transparency and accountability provisions that track participation in programs by race, gender and ethnicity, and protect offices, functions and policy that seek to halt the structural racism long endemic to the US Department of Agriculture and its field offices.

## Notes

**1. From Pennick, J. and Gray, H. (2000). *When Programs Provide a Positive Impact: Providing Technical Assistance to Black Farmers*, Federation of Southern Cooperatives/Land Assistance Fund, Atlanta, GA.**

## *POSTER PRESENTATIONS*

### *ALABAMA*

#### **1. Environmental Impacts of Waste Management Practices at Small Farms/ Ranches in Alabama**

*Derek Wheeler, Duncan M. Chembezi, E'licia L. Chaverest, Joseph Befecadu; Alabama A&M University*

The issue of waste and waste management practices on farms is increasingly becoming a topic of greater importance than in the past. One very important reason is because the improper handling of any waste, including that which is produced by a farm, poses health and environmental threats. The EPA and USDA have set forth and more stringent guidelines as they relate to waste management on farms. With the utilization of animal waste, or manure, as a fertilizer, many farms have had great success. However, the issue of waste runoff has prompted the issuance of new regulations to ensure the safety and quality of America's water supply. Small farms and ranches (less than 300 animal units), however, are exempt from these stringent rules because, individually, they are assumed (wrongly or rightly) to pose no serious threat to nearby water sources and streams. This study examines the collective impact of small farm waste management practices while delving deeper into understanding their influence. The study is based on a survey of 150 small and limited resource farms and ranches with less than 300 animal units. Preliminary findings reveal a number of noteworthy implications regarding waste management, water quality, and producer education.

### *ARKANSAS*

#### **2. Focus on Farmers and Fishermen: The TAA for Farmers Program in the Southern Region**

*Nathan Kemper, Terra Daniels, Ron Rainey; University of Arkansas*

The Trade Adjustment Assistance (TAA) for Farmers program provides technical training to help approved applicants develop business plans and adjust business practices to be more effective in the changing economic environment. In addition to technical assistance, program participants are provided financial assistance in the form of cash payment to implement business plans and the knowledge gained from the training workshops and online modules.

This poster details the 2010-11 TAA for Farmers program that included the commodity groups: catfish, shrimp, asparagus, lobster, and wild blueberries (Maine). This poster focuses on the Southern Region and the 2010 catfish and shrimp programs as well as the 2011 shrimp program. In the Southern Region over 6,000 participants qualified technical assistance training has been carried out through collaborations with 12 land- and/or sea-grant institutions.

The poster highlights program outputs as well as details ongoing evaluation of project impacts. Participants of the program have two primary benefits: 1) they qualify for technical assistance training tailored to the needs of their industry and offered through traditional face-to-face workshops and online training and one-on-one work with a consultant to construct a long term business adjustment plan and; 2) cash payments of up to \$12,000 to help them implement knowledge gained from trainings and strategic changes outlined in the business planning process. Analysis here includes participant profiles, assessment learning outcome, efficacy of online learning, and a summary of program benefits.

*DELAWARE*

### **3. Creating a Diverse Program to Reach Underserved Communities Effectively**

*John Clendaniel; Delaware State University*

The Delaware State University (DSU) Small Farms Program has been evolving for years, but now we embrace the diversity between individual program units to make a stronger overall program. The DSU Agriculture and Natural Resources Extension Team has specialist in six different areas, five educators, a program assistant and a small group of student outreach assistance to assist farmers including socially disadvantaged, small sized, women and beginning farmers. Our team uses conferences, workshops, field days, on-farm demonstrations and one-on-one technical assistance to help farmers stay in the business they love as well as create a positive impact on their farms. During the past 12 months the DSU Small Farms Program has held 26 workshops reaching over 524 farmers; has six on-farm demonstrations on minorities' farms and more. We are creating impacts on farms across the state training farmers on best management practices, labor saving equipment and farm & risk management techniques. Each of our program units work with a different alternative crop or livestock to insure the Delaware farmers can have the opportunities to increase profits and overall well being.

This poster will showcase the different styles of outreach and the value of each to the overall program to encourage other Ag Extension Programs to think outside of the area to make a larger impact on the farmers in their community.

### **4. On the Road with Quicken Deluxe 2012: A Farm and Financial Management Workshop Series**

*Megan A. Pleasanton, Kathryn A. Carroll and John W. Clendaniel,  
Delaware State University Cooperative Extension – Small Farms Program*



A series of farm and financial management workshops featuring Quicken Deluxe 2012® software were held across Delaware during May and July of 2012. Delaware State University-Cooperative Extension's Small Farms Program- Quicken Workshop series featured two different sessions: *Intro to Quicken* and *Quicken Advanced*.

*Intro to Quicken* was designed to provide small farmers with the basics of using the financial management software. Participants worked with case examples to practice entering various bank accounts, the basics of enterprise accounting, as well as tracking income and expenses with the guidance of an Extension Educator. *Advanced Quicken* focused on creating balance sheets, cash flow and tax reports, reconciling bank statements, and also the basics of payroll. Each session lasted approximately two hours and was held on Delaware State University's Mobile Entrepreneurship Teaching (MET) unit. This teaching unit served as a mobile classroom, with computer stations for up to 10 participants. This allowed small farmers the chance to experience Quicken first-hand, with the guidance of an instructor in a small classroom setting close to home. Many participants reported how convenient it was to be able to attend a computer-based course in their respective county.

A total of 36 participants across all three Delaware counties completed the *Intro to Quicken* course, with 9 of these participants going on to complete the *Advanced Quicken* course. All 36 participants received a copy of Quicken Deluxe 2012 software for their personal farm computer. 92% of participants reported being highly likely to adopt Quicken for use in their farm finances.

## **5. Using On-Farm Demonstrations to Reach the Underserved farmers**

*Michael Wasylkowski, John Clendaniel; Delaware State University*

Delaware State University (DSU) has conducted on-farm demonstrations, on our outreach farm and on partnering farmer's farms for years, to reach and educate underserved and beginning farmers. This year the DSU has partnered with six minority farmers to complete different types of demonstration projects across the state. As part of the partnership, DSU extension educators hold field days at farmer's property to show off the best management practices being conducted and to highlight the alternative crop or livestock to other farmers in the area. Since the local farmers are curious about what is happening, they turn up for our field days even if they don't come to other extension events throughout the year. This creates an advantage for this extension practice because of its ability to bring other minority, underserved and beginning farmers to our partner's farms, which is like a form of advertising to get other minorities interested in learning about the practices and alternative crops/ livestock.

DSU has successfully shown different equipment to reduce the labor, best management practices, ethnic crops, alternative livestock, season extension practices and more through on-farm demonstrations and the field days that accompany them to more than 100 farmers.

## **6. The DSU Mobile Meat Processing Lab: Concept and Design**

***Dennis McIntosh, Grant Blank\*, John Clendaniel, Dahlia Jackson-O'Brien, Brigid McCrea and Mike Wasylkowski, Delaware State University Cooperative Extension***

Delaware State University (DSU) Cooperative Extension received funding through the 1890 Capacity Building Program to establish a Mobile Meat Processing Lab (MMPL). With the establishment of our MMPL we will be positioned to develop extension programs targeting food safety. This will include hands-on learning opportunities to educate clientele about proper methods of animal slaughter and meat processing in a USDA certified slaughter/fabrication facility. In addition to the improved training capacity for DSU Cooperative Extension, it is expected that the MMPL will serve as a tool for increasing profitability of our clientele by allowing them access to a USDA certified processing facility. Successful completion of our project will result in two primary products, the MMPL itself, and a detailed operations manual. Once completed, the operations manual will function as an outline from which DSU Cooperative Extension will develop educational and training programs in food safety as it pertains to animal slaughter and meat processing.

As designed, our MMPL will be outfitted to process poultry, small ruminants and fish, corresponding to the needs our clientele in DE. Through this poster we will describe the unique design features that we are building into our MMPL that set it apart from other mobile slaughter units currently in operation throughout the country.

*DISTRICT OF COLUMBIA*

## **7. Is Organic an Option for Me? Resources for Farmers, Ranchers, and Processors/Handlers**

***Betsy Rakola, Mark Lipson, Lisa Ahramjian, and Colleen Rossier; Washington D.C.***

The USDA National Organic Program will launch a new training initiative in April 2012 on organic agriculture. USDA provides support in developing opportunities through market trend analysis and business and marketing tools. This assistance includes overseeing national standards for the production

and handling of agricultural products labeled as organic. Goods that are certified as organic frequently bring higher prices at market, resulting in increased returns for farmers.

The current USDA strategic plan includes a performance measure to increase the number of agricultural operations certified as organic by 25% between 2009 and 2015. By promoting an understanding of organic agriculture, the USDA hopes to encourage producers and handlers of all sizes to consider the organic option. The USDA seeks to strengthen an understanding of and support for organic producers and handlers among government, extension, and research personnel.

The training initiative seeks to promote understanding of organic agriculture through the use of web-based training modules, a brochure, and a marketing poster. Those who complete the training will understand the following:

- The definition and requirements of organic agriculture in the United States,
- The role of the USDA in organic agriculture, and
- Resources for current or potential organic producers and handlers.

## **8. The Perspectives of Socially Disadvantaged Farmers and Ranchers in the Development of Fair and Effective Animal Traceability Standards**

*Bryn Bird, MPH – Rural Coalition, Washington, DC*

Socially disadvantaged producers in the United States have a production base largely concentrated in specialty crop, livestock and mixed production on relatively small sized operations. This sector faces continual challenges in protecting themselves from liability, in meeting complex regulatory and market requirements for fresh and minimally processed products, and in securing access to support for record keeping and other financial and risk management tools. Socially disadvantaged and many other small-scale producers have particular concerns about fairness in the current inspection systems and in any emerging traceability systems, and the impact of the cost and burden of such systems on market access, consumer price and farm income especially in localized food systems. As several groups also import seeds and products, it is also essential to understand APHIS rules and regulations with respect to plant products.

In this poster presentation, we share results from a partnership project between the USDA Animal Plant Health Inspection Services and the Rural Coalition which is building relationships between APHIS and the socially disadvantaged and minority farmers and ranchers community at the local, state and national level, and providing insight into the needs, perspectives and recommendations of diverse socially disadvantaged producers on the development of standards for animal disease traceability that are effective in protecting the public from health risk and producers from economic risks. A Project Working Group coordinated the efforts of community based organizations to lead outreach and to develop an assessment process designed to explore the current understanding and opinions of this population with respect to current inspection systems and the need for new methods. The process engages producers currently producing and selling both plant and animal products, including dairy, hogs, chickens and other livestock and fresh vegetable and fruit products.

*FLORIDA*

## ***9. Sustainable Development***

*Jennifer Taylor, Florida A&M University*

A key issue within global agricultural research and development is the need to focus on the sustainable development of small farmers, resource poor farmers and their families. Though these farmers make up to 90% of the worlds farmers, often they have not had equal access and participation in programs and training designed to assist large producers and agribusinesses.

Generally, agricultural research and extension have sought out medium and large farmers thought more successful, innovative, and readily able to adopt technology and contribute to growth and development. USDA Census suggested that approximately 91% of all farms in the United States are small farms.

It is important to ensure local food security with agricultural management strategies that enhance sustainable agroecological production, encourage local food systems, and embrace the benefits of local and global small farm populations.

FAMU StateWide Small Farm Programs is an active participatory capacity building program designed to assist and equip underserved farming populations toward a thriving sustainable development. The Program uses a holistic, multidisciplinary approach to identify farmer/community, research needs and provide relevant education, hands-on training and technical assistance in alternative agricultural production management systems, organic farming strategies, value-added marketing strategies, sustainable living, alternative energy, etc. to enhance viability, well being and quality of life.

The United Nations General Assembly endorsed a decision to accredit several organizations to the 2012 United Nations Conference on Sustainable Development. These accredited organizations were found to exhibit the necessary attributes of an organization demonstrating expertise in an area of sustainable development relevant to the UN Conference. FAMU Statewide Small Farm Programs was one of the organizations that received distinction and accreditation to participate in the United Nations Conference on Sustainable Development.

## **10. A Comparative Evaluation of EM on Soil Quality and Fresh Yield of *Brassica oleracea* var. *acephala* Grown on Orangeburg Loamy Sand Soil**

***Cassel S. Gardner, Alfredo B. Lorenzo, and Bravo Brown; Florida A&M University***

Effective Microorganisms (EM) is a microbial inoculant designed to improve soil condition and to increase production while reducing the use of chemicals and other synthetic compounds. A field study was conducted to comparatively examine the effects of EM and traditional nutrient sources on fresh leaf yield of collard greens (*Brassica oleracea* var. *acephala*) and post harvest soil chemistry. The study, a 4 x 4 RCBD was conducted on the Research and Extension Center Farm of Florida A&M University, Quincy, Florida, during the fall of 2011. The treatments were 202 kg / hectare of N as ammonium-nitrate fertilizer, mushroom compost, EM at 0.1 percent per hectare, and control. Seedlings were planted on raised beds covered with black plastic, and drip irrigated. The crops were harvested approximately 12 weeks after planting. Data collected includes plant height, plant weight, leaf length, leaf width, root length, and root weight. The fresh yield in kilograms per hectare was derived using aboveground plant weight. Approximately 2 weeks after harvesting, soil cores were removed at 0-15.24 cm and 15.24 cm – 30.5 cm and were processed and subjected to physical and chemical analyses. All data were statistically analyzed using SAS 9.3. Results showed fresh leaf yield was significantly higher in plots treated with ammonium-nitrate fertilizer and mushroom compost than those treated with EM and control. Preliminary analysis of soil chemistry showed no significant differences among the treatments in concentrations of P, NO<sub>3</sub>, TKN; pH, OM, and CEC. This study will be continued to establish more accurate information.

*IDAHO*

## **11. Reducing Risk on Idaho Small Farms and Ranches through Innovative Whole Farm Planning Education**

***Williams, C., Agenbroad, A., DePhelps, C., Lines, M., Green, D., Rohlfing, M., Madsen, C.; University of Idaho***

Our multi-year project was designed to reduce production, marketing, financial and legal risks associated with producing agricultural products for direct and semi-direct markets. Two distinct formats

of innovative on-line education were developed with significant input from individual producers and a regional small farm non-profit, Rural Roots, Inc.

In 2011, 65 Idaho producers enrolled in a 12-week beginning whole farm planning course offered through a facilitated on-line Moodle format. Course topics included: resource evaluation, site appropriate production practices, financial planning, market analysis and food safety. Each week's PowerPoint presentations, readings, and worksheets were enhanced by interactive chat sessions with farmer mentors. By the end of the course, 91% had begun developing or completed a whole farm plan and 86% indicated the course increased their knowledge about ways to improve farm profitability. Lessons learned by the project team were implemented in the subsequent offering of a 9-week advanced level whole farm planning course taught in the spring of 2012.

By March 2012, 30 producers will have completed the advanced course, delivered through an online platform with weekly facilitated webinars. The advanced course was designed for current farmers who have a farm or business plan. Experienced farmers are co-instructors. The course will increase participants knowledge and skills to conduct gross profit and other financial analyses, identify and evaluate marketing opportunities and strategies, mitigate legal risks, and review, revise and implement whole farm plans. Surveys following each webinar indicate a high level of student satisfaction in the course effectiveness and delivery method.

## *KENTUCKY*

### **12. Assistance to Small, Limited-Resource, and Minority Farmers to Incorporate Risk Management Tools in their Farm Enterprises.**

*Victoria Burke, Marion Simon; Kentucky State University*

Kentucky State University develops programs to incorporate alternative enterprises into small, limited-resource, and minority farmers' farms to help them to improve their incomes, lower their risks, and assist with their family well-being. Specifically, the Kentucky State University Cooperative Extension Program provides Extension education to farmers and community groups. Kentucky State University College of Agriculture, Food Systems, and Sustainable Agriculture researchers focus their research efforts toward the needs of this clientele.

Risk management tools for alternative enterprises include many topics, including the need for outreach when small, minority, women and limited-resource farmers are targeted. This poster highlights the tools, teaching methods, and success stories used in assisting Kentucky small farmers to incorporate pastured poultry (meat and eggs) into their farming operations.

### **13. From Producing to Packaging**

*Terrence Marshall, Emily King and Zanetta Augustine, Southern University*

Numerous excellent training programs exist for beef cattle producers. However, many small farmers, especially limited resource and socially disadvantaged farmers, do not participate in these programs. Cost, distance, time involved, conflict with job schedules, and lack of notification or information about the programs are some of the barriers. To bring a comprehensive training course to minority, small-scale beef producers, “From Producing to Packaging” was developed. “From Producing to Packaging” is designed to educate limited resource cattlemen, small farmers, landowners and community leaders on best management practices for beef cattle production, farm management and record keeping, understanding farm taxes, and estate planning. Through this course, participants learn how to produce quality beef that the industry demands and by doing so receive premium prices for their product. The program was offered through Community Cattle Enterprise (CCE), a grassroots organization of primarily African-American beef cattle farmers. It took place in ten sessions, scheduled to fit the monthly meetings of CCE. The program was offered throughout the community and the class included CCE members and other producers. University, extension and USDA specialists conducted the educational sessions.

### **14. Stream Baiting in South Louisiana for *Phytophthora ramorum***

**Jason Preuett, Daniel Collins, Ashley Williams; Southern University**

The use of stream monitoring is an important method for early detection of *Phytophthora ramorum*. Five different waterway locations representing different ecosystems and potential *P. ramorum* inoculum sources across South Louisiana were monitored for *P. ramorum* using bait bags containing whole *Rhododendron* ‘Cunningham’s White’ leaves from December to January 2011. After 1 week, the leaves were retrieved and 30 leaf disks per bait bag (11-mm-diam) were taken from necrotic areas of the exposed leaves and placed on a *Phytophthora*-selective agar medium (PARPH+V8) or 2% water agar and incubated in the dark at 20°C. Plates were monitored for mycelial growth and suspected *Pythium* and *Phytophthora* species were transferred individually to V8 agar to obtain pure cultures. The pure cultures were identified using internal transcribed spacer polymerase chain reaction (ITS PCR). Thirty-four cultures containing ten different Oomycete species were positively identified from all locations, including: *Phytophthora* spp. (2.9%), *P. cryptogea* (11.8%), *P. taxon sylvatica* (11.8%), *Pythium* spp. (14.7%), *Py. aphanidermatum* (2.9%), *Py. diclinum* (14.7%), *Py. litorale* (29.4%), *Py. sterilum* (2.9%), *Py. tumidum* (5.9%), and *Py. undulatum* (2.9%). The Amite River was the only stream baiting study area to contain *Phytophthora* species. *Phytophthora ramorum* was not found.

## **15. Practical Model Farms and Demonstration Sites; A Limited Resource Perspective**

*Odis S. Hill, Southern University Agricultural Research and Extension Center*

Commodity specific and community based experiment stations in the state of Louisiana traditionally conduct research that supports large-scale producers. More often than not, these efforts do not benefit small farmers, who oftentimes have limited access to capital and use different production practices. The Southern University Ag Center agent in Morehouse and Union Parishes, recruits small farmers, who serve as model farmers, and uses their farms as a demonstration sites. The primary objective of this arrangement is to provide community based results from farms in climates similar to the producers. Additionally, this project allows USDA / Natural Resources Conservation Service in particular, the ability to showcase the advantages of their conservation practice on the farmers' land. The Extension agents work with researchers and the farmer(s) and in some instances seed companies, such as Monsanto, to design and plan the demonstration(s). The focus of this outreach activity is to demonstrate the use of recommended cultural and conservation practices. Farm tours and demonstrations are conducted where the participating farmers share their experiences (results) with other farmers. To date, the demonstrations have been focused on livestock health, variety selection and farm management. As a result of participating in these farm demonstration and tours, farmers are better able to make decisions concerning their production practices, varieties to use and overall management of their enterprises. Additionally, these demonstration farms serve as agricultural learning centers in the community for the producers.

## **16. From Producing to Packaging**

*Terrence Marshall, Emily King, Zanetta Augustine; Southern University*

Numerous excellent training programs exist for beef cattle producers. However, many small farmers, especially limited resource and socially disadvantaged farmers, do not participate in these programs. Cost, distance, time involved, conflict with job schedules and lack of notification or information about the programs are some of the barriers. To bring a comprehensive training course to minority, small-scale beef producers, “From Producing to Packaging” was developed.

“From Producing to Packaging” is designed to educate limited resource cattlemen, small farmers, landowners and community leaders on best management practices for beef cattle production, farm management and record keeping, understanding farm taxes, and estate planning. Through this course, participants learn how to produce quality beef that the industry demands and by doing so receive premium prices for their product.

The program was offered through Community Cattle Enterprise (CCE), a grassroots organization of primarily African-American beef cattle farmers. It took place in ten sessions, scheduled to fit the monthly meetings of CCE. The program was offered throughout the community and the class included CCE members and other producers. University, extension and USDA specialists conducted the educational sessions.



## 17. Developing School Gardens in Food Desert Communities

*Tiffany W. Franklin, Stephanie Elwood; Southern University*

In food deserts, the stigma associated with the area are overweight residents which have health issues such as high blood pressure and diabetes. The Southern University Agricultural Research and Extension Center (SUAREC), through its extension program, disseminates relevant information that addresses the social, economic and cultural needs of all citizens, emphasizing particularly the needs of those who are socially, economically, and educationally disadvantaged.

The development of school gardens in food desert areas within close proximity to the SUAREC is essential in building capacity for strengthening existing community gardening efforts and building stronger communities that surround Ag Center's campus by investing in the citizens. SUAREC partnered with Southern University Laboratory High School to pilot the school garden program, as the high school is located on Southern University's main campus, therefore, easily accessible to students. The priority areas are sustainable, urban agriculture and youth development and the concept of the food desert project is to "**plant it, grow it, try it, like it**". The intent of this concept is to develop economically viable communities in food desert areas, which are within 5 miles of the SUAREC.

Community gardens at local elementary and middle schools provide opportunities for students to learn basic gardening techniques that seek to encourage healthier eating choices at a lower cost, develop or enhance leadership skills, and increase environmental stewardship. The overall objective and ideal outcome of the project is to encourage sustainability so that students are able to utilize transferable skills to develop or maintain their gardens at home, school, or community.

*MAINE*

## 18. You Can Series

*Donna Coffin, University of Maine; Thelma Regan, Piscataquis Valley Adult Education; Walter Boomsma; Piscataquis County Extension Association*

Two educational power houses in Piscataquis County collaborated to offer a series of 15 courses to community residents to help them weather tough times by sustaining their families with traditional skills that increase self-sufficiency.

In the fall of 2011 the staff and Executive Committee of the University of Maine Cooperative Extension (Extension) and staff of the Piscataquis Valley Adult Education Cooperative (PVAEC) shared their needs assessments indicating county residents were interested in learning basic homesteading skills to help their families cope with tough economic times through creative ways to feel more independent and gain a sense of control over their living conditions.

Extension had the resource of staff and volunteers to provide educational sessions on a variety of topics. The PVAEC had the logistical capabilities to assemble and mail a course catalog to all residents

in four school districts and manage course enrollments. The effort was dubbed “You Can,” and included 15 affordable classes with topics like Small-Scale Livestock Care, Backyard Maple Syrup and Raise Cash as a Crop.

The result has been a roaring success! PVAEC experienced an increase in enrollments. Extension increased their reach and visibility into the community. Attendees reported learning a great deal which they plan to implement to help their families survive these rough times.

Both organizations are exploring ways to continue to work together to provide valuable educational opportunities in the county.

## **19. So You Want to Farm in Maine**

Donna Coffin, Piscataquis & Penobscot Counties Extension Educator; Kathy Hopkins, Somerset County Extension Educator; & Andrew Plant, Aroostook County Extension Educator

Current farmers thinking about changing farm enterprises and new farmers interested in starting a farm lack the skill, knowledge and confidence to investigate their options to start, adapt and maintain a profitable land-based business. Major issues farmers and potential farmers need to overcome include access to capital understanding of rules and regulations affecting agriculture operations and marketing options.

To enhance the business management knowledge, skills and confidence of new and established farmers, Extension conducted farm business management trainings reaching participants from five counties in Maine using Tandberg MOVI videoconferencing software. Sixty-three participants representing part-time farmers, full-time farmers and those not in farming attended to learn about agriculture enterprise selection, business planning, record keeping, market research, regulations and resource identification.

Knowledge change was assessed by a post evaluation. As a result of attending these training sessions, participants reported the following knowledge and understanding gains:

- 76% learned about the rules and regulations affecting agriculture enterprises and the agencies that enforce them.
- 68% learned where to look for resources and information about their farm enterprise of interest including web resources, government agencies, universities and other organizations.
- 59% learned about the importance of developing a business plan and the items a farm business plan should include.
- 55% learned market research techniques that they could implement to refine the knowledge of markets for their agriculture products.
- 41% learned about production and financial recordkeeping and the different methods that can be used including paper and electronic records.

## **20. Lack of An Effect of Pelletized Diets Containing Pumpkin Seeds on Gastrointestinal Nematode Fecal Egg Counts in Goats.**

M. Gooden<sup>1</sup>, E.N. Escobar<sup>1</sup>, N.C. Whitley<sup>2</sup>, D.J. Jackson-O'Brien<sup>3</sup> and H.Taylor<sup>1</sup>. <sup>1</sup>*University of Maryland Eastern Shore (UMES)*, <sup>2</sup>*North Carolina A&T State University*, <sup>3</sup>*Delaware State University*.

Several researchers at UMES tested alternative natural products (garlic, sericea lespedeza, high tannin sorghum and papaya seeds) to reduce gastrointestinal nematodes in small ruminants to enhance sustainability of small sheep and goat farms. This investigation evaluated the effect of pelletized diets containing ground pumpkin (*Cucurbita sp.*) seeds (PS) on an artificial *Haemonchus contortus* infection in goats. Thirty 6 to 8 month old female and castrated male Boer-crossbred kids at an average BW of  $25.3 \pm 4.9$  kg were used. Following a two week adjustment period in 9 m<sup>2</sup> individual pens with slotted floors, kids were dewormed with albendazole (10 mg/kg) and moxidectin (0.2 mg/kg). After a 21-day dewormer withdrawal period, all kids were orally inoculated 3 times over 5 days with a 3 ml larval inoculum containing 1,450 L3 larvae of *H. contortus*. Goats were fed the experimental diets for four weeks and individual daily feed intake was recorded. Data were analyzed by SAS-PROC MIXED. Weekly, the goats were weighed, fecal samples were taken to determine fecal egg counts (FEC, eggs/g, by the modified McMaster's technique), and blood samples were collected to determine percentage packed cell volume (PCV). After 28 days of continuous feeding a control diet and diets containing up to 21% PS it was determined that there was no effect of the PS treatment on FEC or PCV. PS did not reduce gastrointestinal nematode FEC in young goats. Future trials are designed and will be implemented to determine if PS containing diets will reduce FEC in young lambs.

**Key words:** goats, pumpkin seeds, FEC, PCV, *H. contortus*

## **MISSISSIPPI**

### **21. Determining the Economic Feasibility of Implementing Irrigation on Small-Scale Farming Systems: An economic feasibility study using sweet potato irrigation as a case study**

Rockiell Woods, Gretchen F. Sassenrath, and John M. Halloran; USDA-ARS Crop Production Systems Research Unit

Economic challenges have contributed to an alarming decline in the number of small farms. Small farms are an important source of local food, critically needed in the Mississippi Delta to alleviate the region's severe food deserts. In order for small farms to survive, strategies are required that yield high value fruits and vegetables and enable farmers to remain economically solvent. Two key components of such strategies are: 1) information on management and business practices appropriate for small farm agriculture and 2) access to information and experts knowledgeable of small farming systems. This research was undertaken to improve yield and economic return in small-scale vegetable production systems, using as a case study supplemental irrigation in sweet potato (*Ipomoea batatas* L. Lam) production. Irrigation costs were incorporated into enterprise budgets, and potential return on investment calculated. The results demonstrate that even very modest (10%) improvements in yield are sufficient to economically justify implementing irrigation. Irrigation is a simple tool that farmers can use to enhance their management practices and maximize profits. To improve access of this information to farmers, we are working in collaboration with MSUCares to deliver the knowledge to producers through an easy-to-use, readily accessible internet format (<http://agwater.msucare.com>). The website is easily reached through a variety of platforms, including smart phones, tablets, and desktop computers, allowing free and immediate access irrespective of production size. This research will develop management tools for farmers delivered through online media that enhances their access to production information and improves crop management and business decisions.

## **22. Farming, the Holistic Approach: Small Farm Outreach Training and Technical Assistance Project. (SFOP)**

*Carolyn Banks, Anthony Reed; Alcorn State University*

Limited-resource and socially disadvantaged farmers and ranchers in Mississippi are facing financial difficulties which have contributed to bankruptcy, foreclosures and stressful emotional conditions. Some of the major factors affecting the previously mentioned farmers are the lack of management skills, failure to sustain cash flow, racial discrimination, lack of USDA programs information and inability to make sound decisions.

SFOP provided one-on-one technical assistance in financial management, hands on production education, computer application to encourage electronic recordkeeping, and home budgeting to improve their quality of life, co-sponsored a small farmers conference that reinforced the training previously mentioned, and provided technical assistance in completing federal and state loan applications to enhance, establish and sustain a farming enterprise. During 2011, SFOP provided technical assistance to small Farmers and ranchers that help to spur \$1,677,500 dollars into Mississippi's farming industry with an average loan of \$15,000-\$30,000. Forty-eight thousand three hundred dollars (48,300) was provided from the Mississippi Small Farm Development Center to small limited- resource farmers with an average loan of \$5,000-\$10,000. Forty- Four farmers completed and received a certificate of completion for participating in Venders Borrowers Training classes to meet their USDA-FSA

requirements. Five hundred and fifty-two (552) farmers gained knowledge of low cost conservation practices and five hundred and ninety-three farmers (593) received loan application training to qualify for the zero percent interest (0%) from the Alcorn State University Small Farm Development Center loan.

#### *MISSOURI*

### **23. Hands-on Workshops on Integrated Pest Management for Beginner Small Farmers in Missouri**

*Jaime C. Pinero, Jacob Wilson, Patrick Byers, Debi Kelly; University of Missouri*

The Integrated Pest Management Program at Lincoln University aims at developing (through research) and promoting (through Extension activities) affordable alternative insect pest management strategies to combat insect pests of vegetable crops in Missouri. Emphasis is being made to provide limited-resource and under-represented farmers with research-based information on effective and environmentally friendly IPM tactics. Here, we report on a series of intensive, hands-on IPM workshops for Beginner Farmers that were conducted in Missouri in 2012. In post workshop evaluations, participants indicated significant increases in their level of IPM knowledge. Most growers indicated that they will be implementing at least one IPM practice into their operation. Economic and environmental benefits derived from such implementation are expected in the midterm. Our hands-on educational approach proved effective, and highlighted the collaborative efforts between Lincoln University Cooperative Extension and University of Missouri Extension to reach under-represented farmers in Missouri.

### **24. Exploring Income Opportunities for the Small Farmers of Missouri**

*Miranda Duschack, Kamalendu B. Paul and Sanjun Gu; Lincoln University Cooperative Extension*

The Innovative Small Farmers' Outreach Program (ISFOP) of Lincoln University Cooperative Extension provides research based information and education to under-served and minority farmers and ranchers with the goal of improving their farm income and quality of life. Eight field staff disseminates information through one-on-one consultation with the eligible farmers. Launched in October of 2008, ISFOP staff covers seven counties in the East Central Region, and another seven counties in the West Central Region of Missouri. Of the program's present total client base of 345 clients, 44 are ethnic minorities, and 58 clients are women sole proprietors. In the two program years, ISFOP used individual meetings and workshops to assist its clients, among other things, in increasing their farm income. This poster will

present some of the program's income generating activities, such as Marketing Assistance and Farm Development. Marketing Assistance was offered in the form of facilitating connections between farmers and buyers (Farmers' Markets, direct sales, retail, wholesale, and Community Supported Agriculture). Farm Development was advanced through introduction of new ventures such as pastured poultry and high tunnels and efficient designs such as irrigation and managed grazing systems. In addition, ISFOP field staff assists eligible farmers in securing grant funding from various USDA agencies. A combination of these efforts is making a demonstrable and positive income advances for many small farm families in Missouri.

## **25. The Missouri Minority and Limited Resource Farmers' Conference Promotes USDA Programs and Sustainable Agriculture**

*Sanjun Gu, Catherine Bohnert and K.B. Paul.; Lincoln University of Missouri*

According to the 2007 Agriculture Census, most minority farmers in Missouri had limited resources and fell into the socially disadvantaged farmers' (SDFs) group. The average size of farms operated by an SDF was 132 acres, smaller than the Missouri average of 269 acres, and up to 73 percent of the SDF operated farms were rented. As part of the 1890 Land Grant University, Lincoln University of Missouri Cooperative Extension (LUCE) assists small Missouri farmers, especially those belonging to the SDF group. In the last two years, LUCE's OASDFR Program has identified and worked with 263 SDFs belonging to 132 families in 16 counties. Of these, 47 are African American, 36 Asian, six Hispanic, one Native American and 12 women heads of households. The Innovative Small Farmers' Outreach Program (ISFOP) of LUCE has worked with 345 SDFs in another 14 counties, of which 44 are ethnic minorities and 58 are women sole proprietors. Since Missouri minority farmers often face similar challenges, we organized the first Minority and Limited Resource Farmers' Conference that focused on saving minority farms, sharing relevant details on USDA programs, and promoting sustainable agriculture practices. More importantly, this conference has served as a networking platform for SDFs. Over 130 individuals attended this two-day conference, including 80 limited-resource farmers. Other participants came from various USDA agencies (NRCS, FSA, and RD), MO Department of Agriculture, the Minority Landowners Magazine, and the University of Missouri Extension.

## **26. Get Growing Kansas City: A Collaborative Effort in Urban Agriculture**

***Katie Nixon, Lincoln University of Missouri Cooperative Extension; Katherine Kelly, Cultivate KC; Ben Sharda, Andrea Mathew; Kansas City Community Gardens***

When the Innovative Small Farmers' Outreach Program (ISFOP) was launched three years ago, urban agriculture was not part of the plan. However, responding to the repeated requests for assistance from the urban communities, ISFOP had soon expanded its mission to cover the food production needs of the urban residents as well. Through the efforts of several organizations, Kansas City Metro area already has thousands of home gardens, hundreds of community gardens, and around 50 urban farms, and the demand for assistance keeps growing. To ensure coordination and collaboration and to make the most effective use of available resources, ISFOP teamed up with two other organizations, Kansas City Community Gardens, and Cultivate Kansas City, and started the "Get Growing Kansas City" campaign. With a grant from the Health Care Foundation, we have hired an additional five people and brought our team total to nine. Our team provides one-on-one assistance to beginning growers or expanding urban growing projects. Our target audience lives in areas that have limited access to fresh produce, which also tend to be the metro's low-income neighborhoods. Our clients could be a home gardener, a community gardener, an urban farmer, or a community-based organization working with refugee and/or low-income families. The "Get Growing Kansas City" campaign also assists urban growers by offering mini-grants of up to \$3,000 dollars to help them implement or expand community gardens or urban farming projects in economically depressed areas. The ultimate goal is to have good food growing in every neighborhood.

## **27. Creating an Online Learning Community for Beginning Farmers**

***Mary K. Hendrickson, Debra Kelly, Kenneth Schneeberger, Kevin Moore; University of Missouri***

As part of a USDA-NIFA funded Beginning Farmer and Rancher Development Program project, our University of Missouri team has worked to create an online learning community that can reach a larger number of producers and stimulate interactions among producers who are geographically dispersed. Our goal as part of this project is to provide inexpensive ways for producers to network together to encourage collaboration and support of these farming enterprises; to provide information and resources they will find valuable in creating their enterprises; and to provide a forum for mentoring and support. We first created a static website, linked with an interactive blog, to provide information. We then created an online learning community. Every month experienced farmers present topical information through a webinar and two follow-up question and answer sessions. Not only does this provide a forum for beginning farmers to hear from other farmers, it helps to link those experienced farmers with new or beginning farmers across the state of Missouri. We use the free course management software "Moodle"

to create a place where beginning farmers can watch or review webinars they've missed, and where we can archive materials from our beginning farmer face-to-face workshops. This system also allows for forum discussions, which we hope to develop into networking tools for beginning farmers. We are working to expand the connections created through the online learning community into a form of online mentoring.

*NEW JERSEY*

## **28. Backpack Sprayer Technology: Improving Applications on Smaller or Organic Farms**

*Meredith Melendez, John Grande, Jack Rabin, Ed Dager; Rutgers NJAES Cooperative Extension*

Farms of all sizes depend on backpack sprayers for application of crop protectants. Smaller organic and alternative farms depend heavily on these backpack sprayers throughout the growing season, yet crop protectants that are OMRI approved provide application instructions that often contain little information about application requirements. Many alternative organic products have unusual formulations not extensively tested by sprayer component makers, allowing for a “technology-disconnect” between the manufacturers of crop protectants and equipment manufacturers.

Rutgers NJAES Snyder Research Farm Director John Grande identified this gap for advancing technology using backpack sprayers for alternative smaller farms. John and his NJAES research team are leading the solutions with a \$48,000 USDA Sustaining Agriculture Research and Education grant. 10 backpack sprayer configurations were tested for ease of use, and a blueprint for rebuilding the sprayer wand was created.

Backpack sprayers are cost effective tools that offer many uses to farmers. They provide versatility for spot treatments, odd shaped field margins, field impediments, greenhouses, high tunnels and small plots of short season crops. The resulting educational programs and materials from the NJAES backpack sprayer research provide farms of many sizes and application needs the following:

- Off-the-shelf technologies to retrofit their current equipment.
- More effective use of low-priced backpack sprayers.
- Increased backpack sprayer accuracy, minimizing risks of misapplying chemicals at the wrong rates.
- Successfully applying alternative organic product material formulations.
- Greater farmer/operator ease.
- Better and more efficient use of small farm operator's precious time.
- Increased operator and environmental safety.



NEW MEXICO

## **29. Soil Health Indicators in Selected Organic Production Systems in southern New Mexico**

*Kulbhushan Grover, John Idowu; New Mexico State University*

Small farms represent more than 90 percent of the total number of farms in New Mexico. Many of the smaller farms have focused on producing and marketing organic or locally grown crops. Organic production systems rely on robust soil health to maintain productive cropping systems. Although, information on soil quality assessment already exists in some parts of the United States, there has been no study that has specifically focused on soil quality assessment in organic production systems especially in irrigated semi-arid southwest. Identifying indicators of soil health that are suited to the southwestern region can help organic and small scale farmers to monitor directional changes in soil quality and develop management strategies for soil health improvement. The objective of this study was to assess selected soil physical and chemical indicators including dry aggregate size distribution, wet aggregate stability, salinity, and standard soil chemical measurements in organic production systems. This study demonstrated the utility of selected soil health indicators to distinguish fields that have been managed differently in organic systems, comparing them with neighboring conventional fields in southern New Mexico. Wet aggregate stability and soil salinity were found to be promising indicators of soil health and showed consistent differences between management systems.

## **30. Empowering Beginning Women Farmers in the Northeast through Whole Farm Planning Program**

*Ann Adams, Sandy Langelier; Holistic Management International*

A holistic approach to farm planning and decision-making is successfully preparing women farmers to mitigate their risks. Since risk variables are so dynamic, a method for managing risks that is grounded in decision-making skills prepares the farmer for whatever comes.

For two years the “Empowering Beginning Women Farmers in the Northeast through Whole Farm Planning Program” has served the target population in New Hampshire, Vermont, Maine, Connecticut, Massachusetts, and New York. The 180 women (a total of 270 to be trained) received training in goal setting, decision-making, financial planning, business planning, marketing, time management, leadership and communication, grazing planning, soil fertility, and land planning.

This poster presentation will display a program overview, year one survey results, year two survey results, objectives, course curriculum, program evaluation, and key programmatic changes.

## **31. Integrated Pest Management (IPM): Addressing Small-Scale Farmer Needs in New Mexico**

*Tessa R. Grasswitz, Edmund Gomez; New Mexico State University*

Integrated pest management (IPM) was first developed in the late 1950s to reduce or eliminate unnecessary pesticide use in a variety of cropping systems. Since then, the approach has achieved many notable successes, but much of the research in this field has been focused on large-scale conventional agriculture, leaving small-scale and organic producers underserved. Such producers, however, are often very interested in reducing their inputs and farming in less chemically intensive ways, making them predisposed to adopt IPM for both financial and philosophical reasons. Nevertheless, the diversity of cropping systems, pest problems and farmer demographics represented by the small farm sector can make it difficult to develop appropriate IPM research and extension programs. In New Mexico, for example, the majority of farms are extremely small, with 73% of farmers reporting annual sales of under \$10,000 and less than 50% of producers listing farming as their primary occupation. The high proportion of off-farm employment can make it difficult to reach such clients by conventional means. Hence, as part of the Western Small Farm-IPM Working Group (along with Utah, Washington, California, Idaho and Oregon), New Mexico is currently developing an IPM demonstration project to encourage the adoption of IPM by the states' small-scale growers. We report here on the process involved and progress to date.

## **32. The Broccoli Brigade: A New crop introduction project in Southern New Mexico for Small Farmers**

*Constance L. Falk, Alex Benitez, Mark Uchanski, Eduardo Medina, Paul Gutierrez, Kulbhushan Grover; New Mexico State University*

Research on organic broccoli production at New Mexico State University (NMSU) has shown broccoli grows well in spring and fall in southern New Mexico, a region noted for long, hot summers. Local and state markets for broccoli are also promising, but few growers have adopted the crop for commercial sales. To help local small growers investigate broccoli as a potential new crop, a collaborative research and extension project, the Broccoli Brigade, was initiated in 2011. Growers in underserved communities, Anthony and Chaparral, New Mexico, are in their first season of broccoli production, and the first harvest is underway. A local food cooperative and the NMSU food service have pledged to purchase the broccoli grown in the project at a competitive price.

This poster will present the relevant lessons learned from prior broccoli research projects and the current Broccoli Brigade project outcomes. Prior broccoli research projects focused on identifying cultivars and testing mulches and row covers. The lessons from the Broccoli Brigade include those from the first year of collaboration with our farmer partners and from fertility trials in 2011. The fertility trials are being

conducted in an on-campus replicated experiment, and they examine the impacts of three sources of organic fertility on broccoli production. The fertility treatments tested are liquid fish emulsion, side-dressed vermicompost, and vermicompost extract tea. The yield, market, fertility, and economic results of this experiment will be integrated into a regional production guide for small growers.

#### *NORTH CAROLINA*

### **33. Profitable Farms and Woodlands: A Practical Guide in Agroforestry for Small Farmers and Woodland Owners**

*Idassi, J.O.; Christian, C. S.; Fraser, R.E; Godsey, L.D.; Hill, D.B.; Hamilton, J;; Mentreddy, Rao; Mrema, F., Kome, O., Walter, W.D., and Workman, S.H W.; North Carolina A&T State University*

Many small farms and woodland owners are reluctant to produce tree-based products using traditional forestry practices because the time between planting and income generation is so long. Agroforestry offers advantages over forestry in producing agricultural products throughout the life of the tree so that income flow is not interrupted. Agroforestry systems such as riparian buffers, alley cropping, windbreaks, silvopasture and forest farming provide significant economical and environmental protection opportunities. There is no single practical handbook to guide small farmers and woodland owners in designing, establishing, managing and marketing agroforestry projects that are sustainable. The 1890 Agroforestry Consortium has developed an Agroforestry Working Manual that aims at educating small farmers and private woodland owners on how to develop productive and sustainable family farms and woodlands. Also, the Manual aims at improving the capacity of natural resource educators and landowners to develop woodland management practices that are sustainable, diverse, integrated, profitable and healthy. Our targeted audience involves small farmers and forest landowners with special emphasis on socially disadvantaged farmers and woodland owners. Included are also, educators, scientists and anyone in the general public interested in designing, implementing and assessing the performance of promising agroforestry practices. Each chapter of the manual contains the following themes: Introduction; Economic Potential / marketing; Production Methods: Establishment of Costs (accessibility and availability of materials) and Site Selection; Marketing: Research and Time Schedule; Value-Added Processing; Regulations and; Local Resources. The funding for this project was provided by the USDA-Natural Resources and Conservation Services and the National Agroforestry Center.

### **34. Improving Small Farm Income by Market Driven Vegetable (Asian) Production in North Carolina**

*Ravella, R., Taylor, M., and Reddy, M. R.; North Carolina A&T State University*

Asian vegetables are grown as alternative crops and these vegetables production is vital to the future of North Carolina farmers. Traditionally tobacco growing farmers are facing financial instability and the tobacco industry in North Carolina is declining due to the elimination of tobacco quotas, decline in tobacco exports and increases in excise taxes on cigarette purchases (North Carolina Agricultural Statistics, 2006). Many specialty crops are receiving greater attention as alternatives to tobacco. Growers are becoming successful with crops such as melons, hot peppers, sweet corn, medicinal herbs, and cut flowers etc. At the same time, there is an increasing demand for Asian vegetables in the state due to increase in Asian population and grocery stores. Currently, Asian vegetables that are sold in North Carolina grocery stores are grown and shipped from Florida. The experiment was conducted at the North Carolina A&T State University Farm in Guilford County, NC. Japanese Eggplants (Hansel and Kamo) transplants were grown in plastic trays for 8-10 weeks in a greenhouse before transplanting in the field. Eggplant yields increased with increasing fertilizer rate. At 150 lbs/ac of N treatment Hansel variety gave 83,327 lb/ac under cover crop treatment and 65,153 lbs/ac under no cover crop treatment and kamo variety recorded yields were 68,139 lbs/ac under cover crop treatment and 54,929 lbs/ac under no cover crop treatment. Under similar growing conditions, 75lbs/acre of nitrogen application combined with cover crop incorporation gave yield that is comparable with 150 lbs/acre of nitrogen application.

## **35. The Role of Perennial Energy Crops on a Representative Small Farm in North Carolina**

*Godfrey Ejimakor, Ralph Okafor, Kimona Smith, Kingsley Bonsue and Markee Manning; North Carolina A&T State University*

Producing perennial crops as an alternative enterprise has some inherent advantages due to lower planting costs. Once the initial planting is done, planting costs for subsequent years can be avoided. In this era of high energy prices and clamor for more production of biofuel, perennial energy crops may be a good fit in the portfolio of small farm enterprises. This study assesses whether energy crops such as switchgrass and others will fit as an alternative enterprise on a representative small farm in North Carolina. The study also explores the implications of producing such perennial energy crops on the allocation of farm assets such as land, labor and capital.

Using enterprise budgets, a base mathematical programming model is used to ascertain the optimal combination of crops that could include perennial energy crops. The prices that will make the perennial crops as profitable as the predominant crops are estimated as the ratio of the sum of the contribution margin and the fixed cost for conventional crops to the yield of the perennial crop. A second programming model is estimated by using the estimated prices. The results from the base programming

model are then compared to the results from the second model. The results from the two models are used to ascertain the farm-level implications of producing perennial energy crops on small and medium-sized farms. Initial results indicate that the price of some perennial crops will have to increase by as much as 11 percent in order to successfully compete with conventional crops. This implies that perennial crops are likely to have high shadow prices. Due to the expected high shadow prices for perennial energy crops, such crops are not expected to feature prominently as an alternative enterprise on a small farm. However, at higher prices, perennial crops could become a viable alternative enterprise.

### **36. Bridging the Gap for Immigrant Farmers**

*Der Xiong, Catawba County Cooperative Extension Center, Theresa Nartea, Virginia State University*

North Carolina has the fourth largest settlement of Hmong refugees in the United States, with an estimated population of 15,000 individuals. In 2007, NC A&T State University-Cooperative Extension Program (NC A&T SU-CEP) launched an educational program equipping Piedmont Hmong in specialty crop production and marketing. Innovative partnerships with the United Hmong Association of North Carolina, county Extension offices, and the Virginia State University Cooperative Extension (VSU-CE) Marketing and Agribusiness Program were formed to conduct Hmong outreach. Grant funds from the US Department of Health and Human Services' Office of Refugee Resettlement were used in part to initiate the collaborative program with management recently transferred to the local Catawba County Cooperative Extension Center. Classroom and hands-on training is provided. A field demonstration site with individual garden plots and a shared high tunnel training site provide land. Nearly 60 Hmong families participated in training. Nearly 50% of the farmers have increased farm production by 30%. One-quarter of participants have implemented new soil and water conservation practices (row covers, drip irrigation, and crop rotation). As a result of education, over 10% of participating farmers began selling locally. The program facilitates cooperation and resource leveraging from governmental agricultural and refugee services, and community stakeholders (NC Department of Agriculture and Consumer Services, USDA Farm Services Agency, Soil and Water Conservation Services, and grassroots organizations such as Foothills Connect).

### **37. Organic Nutrient Management in High Tunnels**

*Kurt Taylor, North Carolina A&T State University; Keith Baldwin, North Carolina A&T State University Rickie Holness, Driscoll's strawberry Associates; Grace Summers, North Carolina A&T State University; and Patricia Perez, North Carolina A&T State University*

The North Carolina climate allows for year round tomato production when season extension methods such as high tunnels are used. However, many producers are unaware of effective soil building nutrient practices such as composting, cover crop use, manure application and no-till planting in high tunnels. This project was designed to examine cover crop and composting practices for organic tomato production using high tunnels in the Fall, when prices are relatively high. Two 30' X 96' high tunnels were used at the Center for Environmental Farming Systems in Goldsboro, NC. After harvesting an early spring crop of organically-grown lettuce, three treatments were applied to the soil in each tunnel: 1) neither compost or cover crop, 2) compost, and 3) cover crop. Half of tomatoes planted in compost and cover crop treatments received organic fertilizer, resulting in five overall Treatments. Treatment 1 (T1) was the control-no fertilizer, compost or cover crop; Treatment 2 (T2) was compost only, Treatment 3 (T3) was compost plus fertilizer, Treatment 4 (T4) was cover crop only, and Treatment 5 (T5) was cover crop plus fertilizer. Total tomato yield was higher for T5 (11.3 lbs/plant) compared to T1 (7.493 lbs/plant). Marketable tomato yield likewise was higher in T5 (8.5 lbs/plant) compared to T1 (5.5 lbs/plant). The impact of Downy mildew could have had an impact on production for all treatments, though plants were sprayed with an OMRI approved fungicide, Milstop, but overall, cover crop plus organic fertilizer use produced the highest yields.

### **38. Community Gardens in North Carolina: Growing Food and Communities**

*Lisa Poser, North Carolina A&T State University Cooperative Extension Program; Keith Baldwin, North Carolina A&T State University Cooperative Extension Program; Montreka Dansby, North Carolina A&T State University Cooperative Extension Program, Michelle Eley, North Carolina A&T State University Cooperative Extension Program; Sharon English, Scotland County of North Carolina Cooperative Extension; Santos Flores, Durham County of North Carolina Cooperative Extension; Travella Free; North Carolina A&T State University Cooperative Extension Program, James Peele; North Carolina A&T State University Cooperative Extension Program, Melissa Tomas, North Carolina A&T State University Cooperative Extension Program; Michelle Wallace, Durham County of North Carolina Cooperative Extension; and Meeshay Wheeler, North Carolina A&T State University*

North Carolina has one of the highest rates of food insecurity in the United States, yet is also named the 10th most obese state. Community gardens, places where people work together to grow their own food, have been shown to increase access to healthy, affordable food. N.C. A&T Cooperative Extension

faculty cooperates with local Extension Agents, Garden Coordinators and community members to develop community gardens in order to address issues of food security and unhealthy diet in at-risk communities. Objectives of this CYFAR-funded Sustainable Communities program are: to increase the number of families growing food, to save families money, and to enhance the nutritional quality of family meals. An overarching goal is the development of local-level leadership so the gardens are ultimately community-led. Local- and state-level Extension staff organize regular workdays with gardeners and volunteers, provide gardening and nutrition resources and offer educational opportunities related to growing and preparing food. A blog, Facebook, and YouTube page provide program visibility and house photos, videos and educational information. In 2011 there were fifty-three families gardening at three community gardens. Thirty-three of these families completed surveys or interviews about their experience participating in the community garden. Impact data shows that 97% (32) of those questioned have been successful in growing food for their families and 72% (24) state that they are eating more vegetables and/or are eating healthier. These and other results indicate that community gardens provide various economic, health and social benefits to families and communities.

### **39. Building North Carolina's 10% Campaign**

*John O'Sullivan, Andy Meir, Teisha Wymore, Nancy Creamer, North Carolina A&T State University*

“Local foods” is a growing movement nationwide, but especially in North Carolina. As part of the local foods program at North Carolina, A&T State University’s Cooperative Extension Program, collaborations have been developed with NC State University and NC Department of Agriculture and Consumer Services (all partners in CEFS- the Center for Environmental Farming Systems) to develop a campaign to have North Carolinians buy 10% of their food purchases locally for the benefit of local suppliers as well as consumers. We have a target of \$3.5 billion dollars as 10% of the amount spent by North Carolinians on food. The goal of this poster is to present the steps we have taken to develop this effort, known as the “10% campaign” in North Carolina. The program is delivered through the web and local cooperative extension and direct contact with businesses. The information collected can be traced and used to develop supply and distributor connections in the local food economy in North Carolina. The program has garnered national attention including being reported by Deputy Secretary of Agriculture, USDA, Kathleen Merrigan in a White House “*Know Your Farmer, Know Your Food*” blog on March 12, 2012. Data collected so far shows almost \$14 million worth of local food purchases by more than 5,000 participants.

### **40. Bridging the “Digital Divide” of Small Farm Families and Limited-Resource Farmers Through Computer Literacy and Technology**

## *Courtney T. Owens; North Carolina A&T State University Cooperative Extension Program*

According to the USDA National Agricultural Statistics Service, farm computer usage and ownership in August 2011 was at an all-time low. Computer illiteracy, lack of managerial ability, and lack of electronic buying and marketing skills are all issues that have reduced the ability of some of North Carolina small farmers to sustain their farms profitably. Only 18 percent of North Carolina farms are using internet for farm business management and for purchasing agricultural inputs that include seed, fertilizer, chemicals and farm supplies. Farmers need these necessary tools to compete in the overall global market. It is imperative for all small-scale and/or limited-resource farmers to adopt current computer literacy tools. The Farmers Adopting Computer Technology (FACT) program, created as part of a 2501 Outreach Project in 1998 by The Cooperative Extension Program at North Carolina Agricultural and Technical State University, provides technical education and training resources for small, part-time and limited resource farmers who seek to improve their computer skills and to better manage their farm operations. In 2003, a partnership was formed between North Carolina Agricultural and Technical State University and select North Carolina Community College Small Business Centers to meet the computer technology needs of limited-resource farmers. The cost of the program is provided at low or no cost to qualifying participants. To date, six hundred five (605) farmers have participated in the FACT Program and twenty-eight (28) counties in North Carolina have partnered with NCA&TSU and the NC Community College System to provide the training.

### **41. Strategic Year-Round Vegetable Production Using High Tunnel Technology for Small Scale, Limited Resource Farmers**

*Kurt Taylor, North Carolina A&T State University; Jimo Ibrahim, North Carolina A&T State University; Rickie Holness, Driscoll's Strawberry Associates, Inc.; Grace Summers, North Carolina A&T State University; and Joshua Idassi, North Carolina A&T State University*

North Carolina's agriculture industry accounts for 19 percent of the state's income and employs over 20 percent of the work force. However, traditionally, the number of minority and limited resource farms in N.C. has been steadily declining. One way for small scale, limited resource farmers to sustain their business is to take advantage of new trends and technologies, such as the local foods and high value specialty crops trends in our state. Therefore, NC A&T State University Cooperative Extension provides training to field staff and growers on technologies such as high tunnel use. High tunnels help extend the growing season to allow for marketable high value products outside of the normal season, resulting in higher sales prices. In a 0.05 acre high tunnel, depending on the crop, up to \$10,000 in sales can be obtained. In order to help limited resource farmers to adopt high tunnel use, since 2010, at least 20 demonstrations (University based), field days and workshops have been conducted. In addition, in late



2011, through partial funding by the USDA Outreach Assistance for Socially Disadvantaged Farmers and Ranchers program, at least ten demonstrations for small-scale high tunnels were started on farms across the state. These demonstrations allow those limited resource farmers to adopt the technology at a lower financial risk and demonstrate its use to other farmers. Through evaluation of past events, farmers have been able to produce high quality produce and make more money.

## **42. Plastic Mulch and Drip Irrigation Program in North Carolina**

*Grace Summers, North Carolina A&T State University; Kurt Taylor, North Carolina A&T State University; Rickie Holness, Driscoll's Strawberry Associates, Inc. and Patricia Perez, North Carolina A&T State University*

Plastic mulch and drip irrigation can increase vegetable yields, reduce chemical weed control and help limited resource farmers to sustain their business. Therefore, The Cooperative Extension Program at NC A&T State University provides training to field staff and growers in the use of plastic mulch and drip irrigation. In addition, the equipment needed to use these technologies is available for free use by farmers in four regions of the state. At least 105 farmers were involved in program up to 2010 and more have been added since. In 2010, of the 31 farmers responding to a multiple-format survey, 29 had participated in the program fully; 20 had not used plastic mulch prior to the program and 18 had not used drip irrigation. All began using plastic mulch after the program, and all but 1 began using drip irrigation. Approximately 90% of respondents indicated that the production information provided through the program saved them money and increased income to their farm with 73% of those reporting at least \$1000 and 46% reporting at least \$5000 more income. Increased crop quality and yield was reported by 96.5% of participants. The percentage increases that were reported ranged from 10 to 300%. All respondents reported that the quality of information they received through the program was good (68% reported excellent, 23% reported very good). At least 83.5% of farmers made changes to their farms because of information they received through the program, including adding new/different vegetables, better water and fertilizer management, adding organic practices, using less labor and buying their own plastic mulch equipment.

## **43. Responding to the Needs of Socially Disadvantaged Livestock Producers**

*Roberto Franco, North Carolina A&T State University; Niki Whitley, North Carolina A&T State University; Michelle Eley, North Carolina A&T State University; John O'Sullivan, North Carolina A&T State University; Keesla*

*Moulton, North Carolina A&T State University; Keith Baldwin, North Carolina A&T State University; James Hartsfield, Sampson and Duplin County Cooperative Extension and Amanda Hatcher Duplin County Cooperative Extension*

Pasture-based livestock production systems offer a great opportunity for small scale producers. These operations are an attractive alternative because owners can take advantage of niche markets while keeping costs low. As one of its primary initiatives, the Cooperative Extension Program at North Carolina A&T State University has developed a collaborative educational program targeting small scale, socially disadvantaged outdoor and pasture-based swine and other livestock producers across the state. For the past five years, the program has been funded in part through grants from the USDA Outreach Assistance for Socially Disadvantaged Farmers and Ranchers program. Given the array of production, environmental, business planning and marketing issues associated with raising livestock, especially pigs, on pasture, an integrated educational program was developed including farmer-owned demonstration sites (eight to date). Over 50 events such as farm tours, grower's schools, field days, workshops and conferences have been conducted for extension field staff and farmer training. A marketing cooperative selling almost \$1 million worth of hogs a year, currently around \$33,000/member, was developed through organizational leadership training and support, growing from 5 to 30 members since 2007 and still expanding. At least three new markets have been established for producers through the cooperative. Survey evaluations indicate that participants have made changes on their farms, including changes in biosecurity (100%), animal nutrition/feeding (92%), health management (83%), environmental land management (71%) and more. Impacts of those changes include increased animal sales prices (by 44% for hogs) and/or increased market accessibility among others.

#### **44. Livestock Integrated Parasite Management in North Carolina**

*Niki Whitley, North Carolina A&T State University; Keesla Moulton, North Carolina A&T State University; Roberto Franco, North Carolina A&T State University; Allison Cooper, Orange County Animal Control Shelter; Rene Jackson, North Carolina A&T State University; and Tiffanee Conrad-Acuna, Richmond County Extension Center*

Improper internal parasite (worm) control causes production problems, farm profit losses and also increases the amount of chemical dewormers released into our environment. Additionally, growing immunity of internal parasites to dewormers, in several livestock species, makes it vital to use multiple

methods to control parasites instead just deworming. So, the Cooperative Extension Program at NC A&T State University has developed a livestock integrated parasite management program for multiple species. In part through Southern SARE PDP funding, extension field staff training is offered in livestock parasite management, including hands-on fecal egg counting (FEC) and FEC reduction training. The FEC reduction training is conducted primarily on volunteer stakeholder farms. A FEC kit has been provided to 31 county extension centers to use for farmer training and for farmers to use for parasite management. Assistance/support is provided for agents organizing farmer trainings. So far, 51 field staff and other agricultural professionals have been trained in a group setting (9 were from South Carolina) and 21 were trained in a small group/individual manner, including on-farm training. More than half of those trained have, in return, provided training to their clientele. So far, at least 255 participants were provided with parasite management education. Field staff reported that producers have profited by changing dewormers to save animal lives and/or achieve higher production levels. Also, after using 25 farms for on-farm training, at least 20 owners have changed their deworming or parasite control practices, including using less dewormer.

*OHIO*

## **45. AN “ERA” FOR EXCELLENCE IN SMALL FARM PROGRAM AND EDUCATOR DEVELOPMENT**

*Fisher, J.C., Dugan, D.A., Grimes, J.F., Mangione, D.A., and Stephens, C.R.;  
Ohio State University*

Decreased Extension funding necessitated reorganization of program delivery through creation of Extension Education and Research Areas (EERAs). The Ohio Valley EERA is comprised of ten counties in south-central Ohio staffed by five Agriculture and Natural Resource (ANR) Educators. Quarterly meetings determine program needs, delivery, specialization, and applied research. Educators are required to deliver “Signature Program” education at the county level. This EERA took a new approach and switched emphasis from programming in agronomic crops, crop insurance, and farm programs to collectively work on forages which better reflected the need in our EERA and utilized our expertise. Collaboration with an Ohio Agricultural Research and Development Center, allowed the educators to conduct applied research in forage management, heifer development, and environmental concerns on grass based livestock operations. Subsequent field days were held to report and demonstrate research initiatives. One project example utilized annual forages to extend the grazing season, reduced the need for stored forages, and provided an emergency source of forage. In this demonstration, 41 crossbred heifers grazed a rotation of oats, turnips and rye over a 58 day period. Heifers gained 1.29 pounds/day. Variable feed costs averaged \$1.18 per head/day which is significantly below industry average for replacement heifers. This project demonstrated how to synergistically reduce costs with heifer development and forage production. Educator specializations have been developed in farm management,

marketing, and technology. This enhanced programs for clientele and improved recognition of ANR educators as specialists in signature programs and innovators in program delivery within the EERA and beyond.

*PENNSYLVANIA*

**46. Extension Programming for Small and Part-Time Farmers**

*Jayson K. Harper and Lynn F. Kime; Pennsylvania State University*

Since its inception in 1992, the Small-scale and Part-time Farming Project has provided educational materials to assist producers through the complexities of enterprise selection. The *Agricultural Alternatives* publication series was developed in response to a need for enterprise selection information by an underserved audience often unable to access Extension information through traditional means because of time limitations. This comprehensive series, now containing 62 publications, has helped farmers analyze production alternatives by providing a balanced assessment of crop and livestock enterprises that might be suitable for small-scale and part-time farming operations. Most publications introduce a specific enterprise and cover important issues including marketing, production, regulations, risk management, and enterprise budgeting. Supporting publications are also available that cover business planning, financing, fruit and vegetable marketing, cooperatives, diversification, insurance, enterprise budgeting, managing a roadside stand, irrigation, organic vegetable production, and managing small woodlots.

A second program, the Guide to Farming in Pennsylvania, is a one-stop web site focusing on management issues. The site was prepared as an on-line reference for small- and medium-scale producers and includes sections relating to pre-venture planning, production, marketing, value-added agriculture, and farm transition.

*TENNESSEE*

**47. The National Research Agenda of the American Association of Agricultural Education: Providing Focus for the Human Dimension of Small Farms and Small Farms Education**

***David Doerfert, Texas Tech University; John C. Ricketts, Tennessee State University***

The preamble of the National Research Agenda (NRA) for the American Association of Agricultural Education (AAAE) sought to focus attention and resources on emerging challenges and opportunities in the social dimensions of agriculture in order to increase the possibilities of positive outcomes from their research. As the NRA states, “it is the human dimension that is both the driver and the passenger of change of the U.S. food and agricultural systems.” The AAAE developed the agenda as the “signpost” for researchers seeking to address and impact change for problems facing individuals, organizations, and communities in agriculture. A leadership committee for the agenda decided upon a process and the goals for the project. Given the goals, a three step process ensued: 1) identifying research needs, 2) defining the resulting research priorities, and 3) creating the final national research agenda report and supporting dissemination tools. The initial phase began with a two-round nominal group process, which eventually led to six national research priorities, each with a comprehensive list of key outcomes and explanations of each. Specialist seeking to assist small farms and small farms education will benefit from learning about this resource. This presentation is being presented as a poster so that the maximum amount of discussion and interaction can take place with presenters.

## **48. Developing Successful Small Farm Enterprises**

*Campbell, J.C., Bryant, C.C., Burress, K.M., Groce, R.E., Hughes, D.D., Morris, J.C., Rose, K. L., University of Tennessee Extension; Payne, D.Y., Smith, W.D., Stribling, F., Tennessee State University*

Small farm owners in the south central middle Tennessee area have shown an increased interest in recent years in developing both traditional and non-traditional enterprises. The Developing Successful Small Farm Enterprises program, held in the winter of 2010, consisted of five educational sessions to address the major factors involved with selecting, planning and successfully operating a small farm. The educational objectives of the program were to (1) provide small farm owners with information to assist in making informed decisions, (2) show the importance of in-depth planning when selecting enterprises, and (3) identify resources to assist in planning and implementation of enterprises. Forty-nine individuals enrolled in the program. Participants indicated a composite score of 7.95 on a ten-point scale that the information presented helped them make decisions on how to proceed with their small farm. There was a composite score of 7.41 as to whether the information had caused them to re-evaluate their current plans. Participants were surveyed in December 2010 to determine implementation of new enterprises and/or adjustments to existing enterprises. Fifty-seven percent of participants responded to the survey. Thirty-eight percent had started a new enterprise. Thirty-three percent revised plans for or discontinued

an enterprise. According to the survey, sixty-seven percent plan to make changes in 2011. Survey respondents reported a total of \$33,000 in increased revenue, \$5,000 in increased savings, \$7,000 in reduced production expenses, \$66,000 in machinery and equipment investment, and \$83,000 in buildings and infrastructure investment.

## **49. A Profile of Goat Meat Consumer in the Metro Nashville, TN**

*Enefiok Ekanem, Fisseha Tegegne; Tennessee State University, Mary Mafuyai-Ekanem, LaRun & Associates*

In spite of the availability of information that shows goat meat as a good source of protein with low fat and cholesterol contents, consumption in the United States continue to be limited by ethnic, cultural, social and religious preferences. Increased demand of the meat in the US continues to be popular among selected groups. This notwithstanding, the strong growth in immigrants coming into the country has provided a rather strong demand for goat meat in Nashville. This poster (1) profiles goat meat consumers in metro Nashville area and (2) provides information their preferences for goat meat. A face-to-face survey of metropolitan Nashville, Tennessee residents was interviewed as part of Tennessee State University goat meat marketing project. Data were collected using a 20-item questionnaire developed by the project team. Charts, figures, pictures and tables will be used in presenting the data.

## **50. The Effects of Mulches and Fertilizers on the Growth and Development of Various Herbs Varieties**

*Arvazena E. Clardy, Tennessee State University*

Alternative crop production and marketing strategies for new, small and/or limited resource producers and farmers to supplement their incomes need to be explored and developed. Growing herbs as an alternative crop in Tennessee could be a potential answer to the alternative or niche market for new and small growers. We evaluated two (2) different fertilizers types: Osmocote slow-released 14-14-14 NPK and Peters water soluble 15-15-15 NPK to determined which fertilizer develop healthier plants for the lowest cost and minimum labor and four (4) different mulching techniques: a. Pine Needles only, b.

Black plastic and Pine Needles, c. Landscaping Fabric and Pine Needles and d. Shredded Newspaper and Pine Needles to prevent excessive weeding and preventing the use of herbicides in the herbs beds, therefore producing “herbicide free” plants. Drying and preserving methods were evaluated, group one was dried and stored at room temperature, group two was dried and refrigerated and the third group was dried and frozen, after three months each group will be evaluated for marketability and resale. We evaluated herbs crops for their potential harvesting and marketing ability as an alternative crop for small and limited resources producers.

*UTAH*

## **51. Utah Small Farm-IPM Project: Reaching Underserved Direct-Market Vegetable Producers in an Urban Corridor**

*Diane Alston, Daniel Drost and Erin Petrizz, Utah State University*

As part of the Western Small Farm-Integrated Pest Management (IPM) Working Group, we initiated a three-year project in northern Utah to 1) assess production and pest management needs of small-scale vegetable producers who direct market to their urban neighbors, 2) conduct on-farm pilot studies to better understand the production and pest limitations and demonstrate effective IPM techniques, and 3) develop new vegetable resources on invasive pests. Survey respondents (102) indicated that word-of-mouth (54%) and returning customers (34%) were their primary marketing techniques. Most growers classified their farms as conventional (69%; 80% of acreage), 16% (18% of acreage) primarily used IPM, and 15% (2% of acreage) were organic. Major production challenges were weed and insect control, weather-related problems, and labor costs. Major IPM practices were crop rotation and crop and pest monitoring (biweekly). The majority of respondents agreed that IPM reduces negative environmental impacts and improves worker safety, but was a perceived to be more costly. Grower preferences for pest information were Extension, other growers, and chemical dealers. They rated a vegetable spray guide (doesn't currently exist) and other Extension publications as the valuable sources of pest management information. Utah initiated its first year pilot study in 2011. Six vegetable farms along the highly urbanized Wasatch Front participated with weekly crop and pest monitoring. Several viruses, their insect vectors, and defoliating insects were the primary pests. Cooperating growers received scouting reports and observed pest monitoring tools and techniques. Three fact sheets targeting the target audience were published.

*WASHINGTON*

## **52. Biodegradable Mulches for Sustainable and Organic Crop Production**

*Jeremy S. Cowan, Carol A. Miles, Washington State University; Annette*

*Wszelaki, Jeff Martin, Andrew Corbin; University of Tennessee, Russ Wallace, Texas AgriLife*

Polyethylene (PE) mulch films enhance growing conditions and increase crop yields and quality. Biodegradable mulches (BDM) can reduce non-recyclable waste, conserve resources, and decrease environmental pollution. To be a viable alternative, BDMs must perform comparably to PE. For organic growers, there are several allowable biodegradable paper mulches, however biodegradable plastic mulches currently on the market do not meet the organic standards for at least one of the following reasons: feedstock, formulation, processing, and the unknown fate of degraded material. Currently, there is a petition to the NOSB asking for biodegradable plastic mulch to be allowed in certified organic agriculture. In an ongoing USDA SCRI study at Knoxville, TN, Lubbock, TX, and Mount Vernon, WA, tomatoes grown with biodegradable plastic and paper mulches produced equivalent yields as compared to PE. The fate of degraded materials in the soil following incorporation at the end of the growing season is still being studied.

### **53. Participatory Assessment of the Community and Economic Impacts of Farmers Markets in the Northwest**

*Marcia Ostrom and Colleen Donovan; Washington State University*

While advocates celebrate the rise in popularity of local foods, creating equitable access to good food and vibrant local markets for diverse farmers and communities remains a challenge. Everyone loves farmers markets, but what are their significant economic and community contributions? Throughout the Northwest, small and immigrant farmers struggle to achieve profitability, while many communities lack access to healthy, affordable foods. Are farmers markets benefiting diverse communities of consumers and farmers? Farmers markets constitute one of the most visible cornerstones of farm-direct marketing. Nationally, the number of farmers markets has increased dramatically, with over 6,130 farmers markets in the US. Despite rapid growth, very little has been documented about the opportunities and challenges encountered by vending farmers, neighboring businesses, host communities, and market organizations.

The intermittent and informal nature of markets make collecting data in a consistent and precise way challenging. To research these questions we use a participatory and collaborative approach involving a research team of market managers, farmers, statewide partners such as the Washington State Farmers Market Association and the State Department of Agriculture. Results are informed by Rapid Market Assessments, a market manager survey, a vendor survey, interactive workshops with managers, and USDA data. Our project has identified 160 markets. One of the strongest, farmer-only markets in the state reports average daily sales of \$1,092 per vendor and annual market sales of over \$3 million. Our findings suggest a strong correlation between management strategies, community engagement, and the long-term sustainability and profitability of the market.



WISCONSIN

## **54. Can It Pay To Irrigate Pasture In The North East Part of the U.S.A.?**

*Brian P. Nischke, Golden Sands Resource Conservation and Development Inc.;*  
*Alex Crockford, Thomas S. Kriegl; University of Wisconsin*

Production agriculture greatly depends on adequate rainfall for crop quality and yields. Farm operators using management intensive rotational grazing in their dairy and livestock operations try to maximize pasture use since pasture usually provides their most economical feed. Yet pasture is often perceived as being a low value crop that couldn't justify the cost of irrigation. However, the fact that many pastures are dominated by grasses that are not drought tolerant along with a substantial increase in many agricultural commodity and input prices since 2006 has increased curiosity about the economic feasibility of irrigating pasture in Wisconsin.

A research project was conducted from 2009 to 2011 to determine the economic return of irrigating pasture, supported by a Grazing Lands Conservation Initiative (GLCI) grant. The grant paid for monitoring, testing and for two 12-pod K-line irrigation lines for installation on a cooperating grazing dairy farm that invested in the rest of the irrigation system.

Quantity and quality of pasture yield plus rainfall was measured from irrigated and non-irrigated pasture, side by side on the same soil type, on the cooperating farm for three growing seasons, including one that was extremely dry.

The collected data was carefully analyzed and the results have been described to help farmers understand the circumstances required to make pasture irrigation economically feasible. The results should be applicable to most areas in the northeast quarter of the country and possibly beyond.

## **55. Selection of Potato Varieties for Organic Production Systems – An On-Farm Approach**

*Amy Charkowski, Ruth Genger, Russell Groves, Shelley Jansky, Doug Rouse;*  
*University of Wisconsin*

Organic and specialty potato production offers many additional challenges, in that there is a shortage of healthy seed potatoes for specialty varieties and the performance of most varieties on organic farms is unknown. We collaborate with organic farmers to conduct on-farm variety trials which involve farmers in variety evaluation, in order to provide the most relevant information on variety potential. In 2011 we conducted trials of 34 heirloom and specialty potato varieties on seven organic farms and one organic research station. We found significant yield, size profile and tuber quality differences among varieties and locations. Variety-by-location differences were also seen. Taste and nutrient evaluation is underway. We partnered with Seed Savers Exchange (SSE) to eradicate pathogens from 90 heirloom and specialty varieties from their collection. The varieties were selected based on unavailability from other sources and desirable qualities including disease and insect resistance, early maturity, and attractive tuber characteristics. We produced disease-free seed potatoes from a subset of these lines, providing the first opportunity for effective evaluation of these heirloom potatoes. Since organic potato production requires small volumes of a diverse array of varieties, our research aims to develop economically viable small scale systems for producing high quality seed potatoes under organic management. In 2010, trials of small scale potato production were set up on a research station and on a local organic farm. Red La Soda minitubers were planted into raised beds covered with reflective silver mulch. Yields for some treatments were comparable to conventional seed production yields.

## **56. The Financial Performance of Organic, Grazing and Confinement Dairy Farms**

*Thomas S. Kriegl, University of Wisconsin*

Ten Land Grant Universities plus Ontario standardized accounting rules and data collection procedures to gather, pool, summarize and analyze actual farm financial performance from many sustainable, small farming systems which currently lack credible financial data that producers need for decision-making, in a project initially sponsored by USDA IFAFS grant project #00-52501-9708.

This effort, spawned by USDA IFAFS grant project #00-52501-9708, primarily compares Wisconsin organic dairy farm data to grazing and confinement data. However, the Wisconsin data was also compared to the limited amount of organic data collected in other parts of North America.

This project has over 124 farm years of Wisconsin organic dairy farm data spanning twelve years and many more years of data from other Wisconsin dairy systems to help understand the level of economic competitiveness of organic dairy farming.

Insights include:

1. Actual farm financial data from organic dairy farms is still scarce relative to other dairy systems.
2. The financial performance of organic dairy farms looks dramatically different from one part of the country to the other.

3. A number of individual farms are achieving financial success with an organic system.
4. The price premium was very important to the economic competitiveness of organic dairy farms.

More information about this project can be accessed at <http://cdp.wisc.edu>.

<sup>1</sup> Farm Financial Analyst, UW Center for Dairy Profitability, 1675 Observatory Drive, Madison, WI 53706.

## *Exhibits*

*Alabama*

**Booth # 1**

***Alabama A&M University Small Farms Research Center***

***Duncan Chembezi & E'licia L. Chaverest Alabama A&M University***

The concept of a Small Farms Research Center at Alabama A&M University was first conceived in 2000 with funding from USDA's National Office of Outreach authorized under Section 2501 of the 1990 Farm Bill. The Center is devoted to issues affecting the family farm, and assessing how such issues impact farm profitability and sustainability. The Center provides outreach training and technical assistance in a wide range of areas to small agribusinesses and agricultural producers who are rarely reached by traditional extension machinery. The clientele consist of individuals who usually own/operate/manage small-scale, family-owned or family-managed farms, often with limited resources. Thus, the Center caters and responds directly to the needs of small and limited resource farmers, ranchers, researchers, educators, farm organizations, agribusiness management specialists, extension personnel, and other consumers by providing and disseminating research-based information, publications, outreach and technical assistance, and offering educational programs on small farms topics. The purpose of this exhibit is to share our successes with conference participants and showcase the various tools, resources and services that are offered by the Center to assist agricultural producers, especially small and limited resource farmers and ranchers in underserved communities.

*Arkansas*

**Booth #2**

***Market Maker: A Free Online Resource Linking Agricultural Markets***

***Terra Daniels, Shalanda Lucas, Nathan Kemper and Ron Rainey,  
University of Arkansas***

MarketMaker is a free online marketing resource available to farmers, businesses, and consumers. It is an interactive web resource aimed at promoting the products and businesses of agricultural producers. It

is designed to connect food producers, distributors, buyers, and sellers to their specific consumer markets. Using a web based search engine of databases in a GIS (global information system) environment, MarketMaker links food producers with economically viable markets, while aiding in food security and enhanced quality in food supply chains.

MarketMaker is a national partnership of land grant institutions and State Departments of Agriculture dedicated to the development of a comprehensive interactive data base of food industry marketing and business data. It is currently one of the most extensive collections of searchable food industry related data in the country. All the information can be mapped and queried by the user. The resource is currently one of the most extensive collections of searchable food industry related data in the country, containing nearly 500,000 profiles of farmers and other food related enterprises in Arkansas, Alabama, Colorado, District of Columbia, Florida, Georgia, Illinois, Indiana, Iowa, Kentucky, Louisiana, Michigan, Mississippi, Nebraska, New York, Ohio, Pennsylvania, South Carolina, Texas and Wyoming.

### **Booth #3**

#### ***Extension Risk Management Education Program***

#### ***University of Arkansas Division of Agriculture – Southern Risk Management Education Center***

**Sandy Martini, Ronald L. Rainey and H.L. Goodwin, University of Arkansas**

The challenging economic environment of 2012 highlights the increasing need to understand and evaluate business risks. Understanding risk is further escalated in the agriculture sector because the landscape of agriculture is changing. The 2007 Census of Agriculture highlights a continued trend toward more diversity among agricultural producers. Managing risk is particularly important for beginning farmers, small farmers and diverse farmers. They generally have fewer financial resources and thus are far more susceptible to the negative impacts of production, price, financial, human, or legal risk. This changing agricultural population heightens the need for risk management tools and resources to support farmer and rancher business decisions. Many of these mid- to small- sized operations engage in specialty crop production and/or rely on off-farm income, agri-tourism and recreational services. Regardless of the type of enterprise in which producers are engaged, in today's risk environment they need guidance on how to mitigate those risks. The Extension Risk Management Education program delivers tools and resources in a coordinated effort across the country that addresses the full array of agriculture risks facing increasingly diverse agricultural producers. Extension Risk Management Education is delivered to producers throughout the U.S. via four regional centers. Each center requests results-focused grant applications that address current risk management issues. Since 2003, Extension Risk management education has funded 892 local projects that directly impacted 170,000 participants.

### **Booth #4**

## ***Natural Resources Conservation Service's Successes with Small and Underserved Producers***

**Burthel Thomas and Alvin Peer, USDA-Natural Resources Conservation Service, Little Rock, AR**

The Natural Resources Conservation Service exhibit showcases services to many small and underserved producers in Arkansas, as shown below. Many of the producers received 90 percent cost-share. Dr. Dwayne Goldmon, through NRCS' Environmental Quality Incentives Program (EQIP), has precision land-leveled a field and installed an irrigation regulating reservoir. He also installed a tail water return ditch, underground irrigation pipeline, pumping plant, and grass waterways. Goldmon grows corn, rice, soybeans and winter wheat on his model farm. I think some "black farmers may be pulling away from USDA at a time when USDA is increasing its outreach efforts and making progress. There is nothing wrong with USDA that cannot be fixed with what's right with USDA. NRCS as an agency has set a model that would be beneficial for other agencies to duplicate. I have enjoyed watching the interest of other farmers when I am applying NRCS programs to my farm – particularly underserved farmers who may not have previously had access to those programs," Goldmon said. Lee Pauley, an 86-year-old farmer, watered his crops with a water hose. Now, he waters 10 acres by turning a spigot. Through USDA's StrikeForce Initiative and EQIP, Pauley received a well and 4,620 feet of irrigation pipelines. Sandra Martin increased her growing season and profits with a high tunnel that allows her to get produce to the farmers market six weeks earlier in the spring and six weeks later in the fall. NRCS is an equal opportunity provider and employer.

### **Booth #5**

#### ***University of Arkansas Pine Bluff's Small Farm Program***

**Henry English, University of Arkansas, Pine Bluff, AR**

The University of Arkansas at Pine Bluff was created in 1873 for the convenience and well-being of the poorer "classes". The UAPB Small Farm Program provides direct assistance (production, marketing, economic) to small farms in Arkansas. Producers are also educated on USDA programs that may be used to improve their operations.

### **Booth #6**

#### ***Southern Sustainable Agriculture Working Group***

**Julia Sampson, Southern SAWG, Little Rock, AR**

The mission of Southern Sustainable Agriculture Working Group is to empower and inspire farmers, individuals, and communities in the South to create an agricultural system that is environmentally sound, economically viable, socially just and humane. Because sustainable solutions depend on the involvement

of the entire community, SSAWG is committed to including all persons of the South without bias. We seek to have a display which shows our work in 13 states in the South. We would like to focus on our brand new instructional DVD, "Producing and Marketing Lamb" by farmer/producer Earl Jones, of Slaughter, LA.

Also, we'd like to publicize our upcoming annual conference to be held January 23-26, 2013 in Little Rock, AR. Our website is [www.ssawg.org](http://www.ssawg.org).

*California*

**Booth #7**

***eXtension- A Research-based Learning Network for America's Small Farmers***

**Terry Meisenbach and Lynette Spicer, eXtension Communities & Marketing, Rancho, Mirage, CA**

This exhibit will feature information and contacts with the various eXtension Communities of Practice with greatest application for America's Small Farmers. More than 70 eXtension communities bring experts from America's land grant university system together to provide the "best of the best" information and education on topics relevant for today's small farmers. From entrepreneurship to small ruminants to organic farming and forestry, eXtension brings dynamic content and learning lessons from the Extension office to the field via desktop, laptop, tablet and smart phone. Learn how all these technologies and today's social media intersect to make the best educational experience and informational source for farmers any where, any time, and on any Internet ready device.

*Delaware*

**Booth #8**

***Impact of the Workshop Series about Farm Business Planning in Small Farmers of Delaware***

**Lekha N. Paudel, John Clendaniel, Delaware State University, Dover, DE**

Small farmers are still lack of resources they need to stay in farm to support their family needs. Knowledge and information is one of the lacking part to the small farmers. Therefore a workshop series in partnership was conducted in Dover, Delaware during February and March of 2012. The purpose of the workshop series was to educate small farmers about basics of farm business planning. Evaluation report shows that farmers are eager to gain knowledge and 96% of participants found workshop and subject matter highly useful. More than 84% said that they will implement the knowledge they learned within a year ahead in their farm. Workshop was sponsored by Risk Management Agency of USDA. Key Words: Small Farmer; Farm business planning; Workshop; Evaluation.

*District of Columbia*

**Booth #9**

### ***Natural Resources Conservation Services' Outreach Program***

**Eston Williams, Natural Resources Conservation Service, Washington, DC**

The Natural Resources Conservation Service motto is (helping people help the land). This exhibit will focus on the three categories: 1) A Beginning Farmer or Rancher means an individual or entity who has not operated a farm or ranch, or who has operated a farm or ranch for not more than 10 consecutive years. This requirement applies to all members of an entity.

2) Socially Disadvantaged. A socially disadvantaged group is a group whose members have been subject to racial or ethnic prejudice because of their identity as members of a group, without regard to their individual qualities. These consists of American Indians or Alaskan Natives, Asians, Blacks or African Americans, Native Hawaiians or other Pacific Islanders Hispanics. Gender alone is not a covered group for the purposes of NRCS conservation programs. 3) Limited Resource Farmer or Rancher. A Limited Resource Farmer or Rancher or Forest Owner is an applicant is defined farmer with direct or indirect gross farm sales not more than the current indexed value in each of the previous 2 years, and who has a total household income at or below the national poverty level for a family of four, or less than 50 percent of county median household income in each of the previous 2 years. An entity or joint operation can be a Limited Resource Farmer or Rancher if all individual members independently qualify. The exhibit will identify the programs that we provide to our underserved and disadvantages customers.

**Booth #10**

### ***Farm to School: Marketing Opportunities for Small Farms and Processors***

**Deborah Kane, National Director, USDA Farm to School Program**

**Christina Connell, Food and Nutrition Service, USDA**

**Charles Parrott, Agricultural Marketing Service, USDA**



## **Matthew E. Russell, Agricultural Marketing Service, USDA**

Over the past decade, interest in local and regional food has grown considerably throughout the United States. This holds true for K-12 school meal programs, where a growing number of communities are establishing farm to school initiatives to better integrate school food and educational programs with local and regional food systems. This growing interest presents market opportunities for small farms and food processors. This exhibit will provide information about farm to school initiatives, the USDA Farm to School Program, the upcoming USDA Farm to School grant program, and where to go for additional resources provided by the USDA and national and regional nonprofits. The resources will target small farms and community partners interested in establishing or expanding farm to school initiatives.

## Booth #11

### *The USDA Risk Management Agency*

**Sharon Hestvik, David Wiggins, and Ron Brown, USDA- Risk Management Agency, Washington, DC**

**The USDA Risk Management Agency (RMA)** promotes and regulates sound risk management solutions to improve the economic stability of American agriculture. RMA offers Federal crop insurance products through a network of private-sector partners, overseeing the creation of new risk management products, seeking enhancements in existing products, ensuring the integrity of crop insurance programs and offering outreach programs aimed at equal access and participation of underserved communities and providing risk management education and information. **Risk Management Education and Outreach Partnership Program:** Partnership agreements are awarded to qualified partners who will provide crop insurance education and risk management training to farmers and ranchers. This Program is designed to help ensure that farmers and ranchers effectively manage their risk through difficult periods, helping to maintain America's robust food supply and the survival of limited-resource, new and beginning farmers or ranchers, legal immigrant farmers or ranchers, socially disadvantaged farmers or ranchers, and other traditionally underserved farmers. Authority for funding is from the Federal Crop Insurance Act.

## Booth #12

### *The Grain Inspection, Packers and Stockyards Administration (GIPSA)*

**Peter J. Jackson, III, USDA / Grain Inspection, Packers & Stockyards Administration**

The Grain Inspection, Packers and Stockyards Administration (GIPSA) was established in 1994 from the joining of two previously independent agencies: the Federal Grain Inspection Service and the Packers and Stockyards Administration. Today, GIPSA is part of USDA's Marketing and Regulatory Programs, which are working to ensure a productive and competitive global marketplace for U.S. agricultural products.

**The Federal Grain Inspection Service (FGIS)** was established by Congress in 1976 to manage the national grain inspection system, which initially was established in 1916, and to institute a national grain weighing program. FGIS facilitates the marketing of U.S. grain and related agricultural products by establishing standards for quality assessments, regulating handling practices, and managing a network of Federal, State, and private laboratories that provide impartial, user fee funded official inspection and weighing services.

**The Packers and Stockyards Program (P&SP)** is the offspring of the Packers and Stockyards Administration, which was established in 1921 under the Packers and Stockyards Act. The organization was instituted to regulate livestock marketing activities at public stockyards and the operations of meat

packers and live poultry dealers. P&SP promotes fair business practices and competitive environments to market livestock, meat, and poultry. P&SP fosters fair competition, provides payment protection, and guards against deceptive and fraudulent trade practices that affect the movement and price of meat animals and their products. P&SP's work protects consumers and members of the livestock, meat, and poultry industries.

Please visit USDA's Grain Inspection, Packers and Stockyards Administration on the web at:  
<http://www.gipsa.usda.gov/>

### **Booth #13**

#### ***USDA Agricultural Marketing Service (Office of Outreach)***

**Billy Cox, USDA Agricultural Marketing Service, Washington, DC**

USDA's Agricultural Marketing Service strives to reach out to small-, mid-size, and underserved farmers and ranchers and has a number of programs and services available. Among the most popular programs offered include: organic certification; marketing opportunities grants; USDA Market News price reports; farmers market advice, assessment, and design services; and direct marketing research and advice. Other services include research on food hubs and distribution infrastructure, Perishable Agricultural Commodities Act (PACA) protection for produce sellers, and information on how to sell products to be used by Federal food assistance programs. For more information on USDA's Agricultural Marketing Service, visit our Web site at [www.ams.usda.gov](http://www.ams.usda.gov), or call us direct at (202) 690-0487.

### **Booth #14**

#### ***Start2Farm.gov***

**Marjorie Porter, USDA-National Agricultural Library, Washington, DC**

The Start2Farm site and program are a project of the National Agricultural Library in partnership with the American Farm Bureau Federation. Start2Farm is funded through a USDA, National Institute of Food and Agriculture (NIFA), Beginning Farming and Ranching Development Program grant and was developed to assist people new to farming or ranching and those who have less than 10 years experience. Start2Farm.gov features information and resources for training and assistance programs available throughout the country, including those produced through the NIFA Beginning Farmer and Rancher Development Program. The Start2Farm clearinghouse will serve as a one-stop reference for anyone looking for programs and resources to start farming and to be successful in their first years as a farmer or rancher. Start2Farm includes programs and resources from federal and state agencies, educational institutions and non-governmental organizations including grassroots organizations. There are four

types of services we identify at Start2Farm: education and training, financing, technical assistance, and networking. Information on the display includes the website URL and a brief description of the website.

## **Do you Know the USDA's *Know Your Farmer, Know Your Food Initiative?***

Demo

***Wendy Wasserman, USDA-AMS & Mary Ahearn, USDA-ERS***

*Know Your Farmer, Know Your Food* (KYF) is a USDA wide initiative coordinating the Department's work in local and regional food systems. From strengthening market opportunities, to tackling key research questions to creating stronger programs in support of local and regional foods, KYF is at the core of local food systems development. At this demo, you will meet some of the members of the USDA KYF team and learn how their multi-disciplinary approach can help you and your community. KYF representatives will also demo the Know Your Farmer, Know Your Food Compass, a web based resource and accompanying searchable map illustrating how USDA's programs and resources are supporting food systems across the country and ideas for how these programs can work for you. This demo will be of great interest to field staff, planners, program officers, researchers and other local food practitioners.

***Booth #15***

***Agroforestry -USDA-Forest Service***

**Cheryl Bailey, U.S. Forest Service, Washington, DC**

**The USDA, Forest Service is staffing two exhibit booths:** one focusing on **Agroforestry**; and the other one displays the Forest Stewardship message. Agroforestry is the blending of trees, shrubs and other perennial plants into common agricultural or livestock operations to increase farm income and provide environmental services such as soil protection, cleaner air and water, and homes for wildlife. The potential for increased income is possible because annual crops and long-term tree crops are grown, or integrated, on the same piece of land.

**Booth #16**

***Forest Stewardship Program USDA-Forest Service***

**Cheryl Bailey, U. S. Forest Service, Washington, DC**

Authorized by the Cooperative Forestry Assistance Act of 1978, the **Forest Stewardship Program** (FSP) provides technical assistance, through State forestry agency partners, to nonindustrial private forest (NIPF) owners to encourage and enable active long-term forest management. Publications, materials, and other information being shared, will include:

Profitable Farms and Woodlands: a practical guide in agroforestry for landowners, farmers and ranchers. This handbook is a joint effort of the Agroforestry Consortium of the 1890 Land Grant Universities and the USDA National Agroforestry Center.

1. Climatic changes
2. Minority Landowner Magazine issues
3. Materials from the Office of Civil Rights/Outreach & Diversity
4. New MOU with Southern University
5. Community Forest and Open Space Conservation Program (Community Forest Program)
6. Forest Legacy Program
7. Ecosystem Services
8. Conservation Education
9. Fire & Aviation Management

### **Booth #17**

#### ***A Condensed History of American Agriculture 1776–1999***

**USDA-NASS, Office of Communications, Washington, DC**

A pictorial narrative from published by USDA-ERS includes the First American agricultural periodical, the establishment of Agriculture Committee, U.S House of Representatives, Other establishments include the growing use of factory-made agricultural machinery increased farmer's need for cash and encouraged commercial farming; the drive for agricultural education culminated in the passage of the Morrill Land Grant College Act, Homestead Act gave free public land to persons willing to farm it; Availability of barbed wire allowed fencing of rangeland, and ending era of unrestricted, open range grazing.

### **Booth #18**

#### ***USDA Animal and Plant Health Inspection Service, Washington, DC***

**Kenneth Johnson, USDA-APHIS, Washington, DC**

USDA Animal and Plant Health Inspection Service provide leadership in ensuring the health and care of animals and plants. <http://www.aphis.usda.gov/>

### *Booth #19*

## ***USDA National Institute of Food and Agriculture***

### **Denis Ebodaghe, USDA-NIFA, Washington, DC**

NIFA advances knowledge for agriculture, the environment, human health, well being, and communities through national program leadership and federal assistance.

### *Booth #20*

## ***Land Grant Colleges and Universities***

### **Denis Ebodaghe, USDA-NIFA, Washington, DC**

The concept of publicly funded agricultural and technical educational institutions first rose to national attention through the efforts of Jonathan Baldwin Turner in the late 1840s.<sup>1</sup> The first land-grant bill was introduced in Congress by Representative Justin Smith Morrill of Vermont in 1857. The bill passed in 1859, but was vetoed by President James Buchanan. Morrill resubmitted his bill in 1861, and it was ultimately enacted into law in 1862. Upon passage of the federal land-grant law in 1862, Iowa was the first state legislature to accept the provisions of the Morrill Act, on September 11, 1862. Iowa subsequently designated the State Agricultural College (now Iowa State University) as the land grant college on March 29, 1864. The first land-grant institution actually created under the Act was Kansas State University, which was established on February 16, 1863, and opened on September 2, 1863.<sup>1</sup> The oldest school to hold land-grant status is Rutgers University, founded in 1766 and designated the land-grant college of New Jersey in 1864. A second Morrill Act was passed in 1890, aimed at the former Confederate states. This act required each state to show that race was not an admissions criterion, or else to designate a separate land-grant institution for persons of color.<sup>[8]</sup> Among the seventy colleges and universities which eventually evolved from the Morrill Acts are several of today's historically black colleges and universities. Though the 1890 Act granted cash instead of land, it granted colleges under that act the same legal standing as the 1862 Act colleges; hence the term "land-grant college" properly applies to both groups. Later on, other colleges such as the University of the District of Columbia and the "1994 land-grant colleges" for Native Americans were also awarded cash by Congress in lieu of land to achieve "land-grant" status. In imitation of the land-grant colleges' focus on agricultural and mechanical research, Congress later established programs of sea grant colleges (aquatic research, in 1966), urban grant colleges (urban research, in 1985), space grant colleges (space research, in 1988), and sun grant colleges (sustainable energy research, in 2003). West Virginia State University is the only current land-grant university to have surrendered its land-grant status, which happened in 1957, and to

later regain this status, which happened in 2001; and is also the smallest land-grant university in the country (Source: Wikipedia)

### Booth #21

#### ***Community-Based Organizations***

**Denis Ebodaghe, USDA-NIFA, Lorette Picciano, Rural Coalition;  
Washington, DC**

According to 20 USCS § 7801(6), the term “community-based organization” means “a public or private nonprofit organization of demonstrated effectiveness that--(A) is representative of a community or significant segments of a community; and (B) provides educational or related services to individuals in the community.”

### Booth #22

#### ***USDA-National Agricultural Statistics Service,***

***Michelle Radice, USDA-NASS, Washington, DC***

The USDA's National Agricultural Statistics Service (NASS) conducts hundreds of surveys every year and prepares reports covering virtually every aspect of U.S. agriculture. NASS provides the basic agricultural and rural data needs for the people of the United States, those working in agriculture, and those living in rural communities by objectively providing important, usable, and accurate statistical information and services needed to make informed decisions.

NASS is also responsible for conducting the census of agriculture program that provides comprehensive information about the Nation's agriculture every 5 years. The Census of Agriculture is a complete count of U.S. farms and ranches and the people who operate them. Any person with estimated or expected annual sales of agricultural products of at least \$1,000 is considered a producer and is counted on the census. This exhibit displays publications and products from the Census of Agriculture and other NASS surveys.

### Booth #23

#### ***Farm Bureau Local Food Projects***

**Sabrina Matteson, American Farm Bureau Federation, Washington, DC**

Farm Bureaus around the country are involved in many initiatives to strengthen rural communities through economic development. State Farm Bureaus are collaborating with others in local and regional food projects to create economic opportunities for farmers and ranchers. Here are a few examples: Virginia Farm Bureau's "Save Our Food," was created because, "according to the U.S. Department of Agriculture, Virginia has lost an average of 104,000 acres of farmland every year since 2002. That's 285 acres a day. When those farms disappear, we lose much more than just land: We lose access to safe, fresh, locally grown produce, grains, meats and dairy products, we lose hundreds of jobs and thousands of dollars in revenue that supports our community economies." San Mateo County Farm Bureau's "As Fresh As It Gets" wanted to bring attention to the abundance of products from this California coastal area. Farmers, fisherman, restaurateurs and hotel owners work together to offer residents and visitors alike the excellent farm products from the region. Arizona Farm Bureau's "Fill Your Plate" is a website that connects farmers to consumers. Find out what is in season, where to find it, where the farmers' markets are, how to cook what you bought at the market and nutrition info. The Farmer Forum encourages dialogue between food producers and eaters, and you can even visit Arizona farms by visiting their video page. Other projects are Discover Jo Daviess County (IL), Indiana Farm Bureau's New Food For Thought, the Kentucky Roadside Farm Markets, and Tennessee Farm Fresh

*Florida*

**Booth #24**

### ***U.S.-Invasive Species Extension Educational Materials for Small Farms***

**Stephanie D. Stocks, Entomology and Nematology, University of Florida, IFAS, Gainesville, FL**  
**Susan T. Radcliffe, North Central IPM Center, University of Illinois at Urbana-Champaign, Urbana, IL; Martin W. Draper, National Program Leader, Plant Pathology, USDA-NIFA, Washington, D.C., Amanda C. Hodges, SPDN, Entomology and Nematology, University of Florida, IFAS, Gainesville, FL**

Protect U.S., the community invasive species network ([www.protectingusnow.org](http://www.protectingusnow.org)) educates small farmers, homeowners, the general public, and K-12 audiences about invasive species. It is a collaborative partnership between the National Plant Diagnostic Network (NPDN), Regional Integrated Pest Management (IPM) Centers, United States Department of Agriculture, Animal and Plant Health Inspection Service, Plant Protection and Quarantine (USDA-APHIS-PPQ), National Institute of Food and Agriculture (NIFA), the National Plant Board, the Department of Homeland Security (DHS), Land Grant University Extension, and other organizations involved in invasive species issues. Protect U.S. delivers their educational content online (at no charge) in three different formats: scripted presentations, e-learning modules, and K-12 lesson plans. The scripted presentations are for educator use (e.g. professors, county extension agents, crop consultants, and master gardener trainers). The e-learning modules (which are based on the scripted presentations) are for use by small farm producers, master gardeners, homeowners, and the general public. K-12 lesson plans are based on the National Science Education Standards (particularly the Life Science standards) and feature a scripted presentation for the



teacher to use in their classroom with several grade appropriate activities from which to choose for the students (e.g. an experiential assignment, a report project, and a computer lab activity in the form of a customized e-learning module). These multiple delivery options and material content allow Protect U.S. to provide invasive species educational options to many diverse audiences.

## Booth #25

### ***Bundling Elements of Federal Support Programs for Underserved Small Farming Communities and Rural Microbusinesses/Enterprises in Selected Southern States: A North-South Institute, Inc. Experience***

**Dr. Samuel W. Scott, North-South Institute, Inc; Davie, FL**

This presentation will demonstrate success stories highlighting practical and innovative ways in accessing and delivering Federal Programs under USDA to Underserved Small Farming Communities and Rural Microbusinesses/Enterprises in selected Southern States. A collaborative partnership is required between beneficiaries, local CBOs, universities, and the county/state agencies responsible for the implementation of these programs. Targeted beneficiaries require a basket of services and resources that include: technical assistance; training and access to financial resources to implement the requisite changes beneficiaries are taught. The implementation of these federal programs can be highly “projectized” which allows for fragmentation in delivery. NSI has experienced success in instances where understanding partnerships between state and county offices, CBOs, and interested beneficiaries. These stories highlight six (6) Federal agencies and twelve programs that primarily serve the client groups and beneficiaries:

- (1) Farm Service Agency - NAP and specified Loan Programs
- (2) Natural Resources and Conservation - EQIP and Hoop House Programs
- (3) Rural Development – Rural Microenterprise, Business and Industry Loans, and Rural Cooperative Program
- (4) National Institute for Agriculture – 2501, Specialty Crop Research Initiative and the Beginning Farmer Program
- (5) Risk Management Agency – Partnership for outreach and education
- (6) Agriculture Marketing Services – Farmers Market Promotional Program

Success stories will focus on the following levels:

- (a) Targeted Beneficiaries - capacity, knowledge, physical capital, and program work follow-through
- (b) County Offices - agent capacity, attitude, and willingness to work with targeted beneficiaries
- (c) CBOs and Universities - agent capacity, resource endowment, ability to forge relationships, creativity in building programs

Georgia

Booth #26

***One Program, Six Grant Opportunities: Advancing Sustainable Agriculture Innovations***

**James Hill and Candace Pollock, Southern SARE Program,  
Fort Valley State University, Fort Valley, GA**

SARE's vision is an enduring American Agriculture of the highest quality. This agriculture is profitable, protects the nation's land and water, and is a force for a rewarding way of life for farmers and ranchers whose quality products and operations sustain their communities and society.

**Grant Making .....** SARE offers grants to farmers, ranchers, researchers, and agriculture professionals for on-farm research, education, and professional and community development. SARE supported projects address pest management, energy, stewardship, marketing, systems research, and much more.

**Engagement .....** SARE shares research results by funding training for agriculture professionals and requiring project outreach such as field days and workshops.

**Farmer leadership .....** Hundreds of producers from all corners of the nation and its territories advise SARE.

**Resources .....** SARE Outreach and regional communications specialists translate SARE's more than 20 years of applied research results into newsletters and practical books, bulletins and online resources for farmers, ranchers, and agriculture professionals.

The Southern Region SARE Program offers six grant opportunities for farmers, ranchers, researchers, and agriculture professionals: Research and Education Grants; Professional Development Grants; Graduate Student Grants; Producer/Rancher Grants; On-Farm Research Grants; and Sustainable Community Innovation Grants.

Research and Education projects are conducted by teams of inter-disciplinary researchers specializing in sustainable agricultural systems. R&E grants encourage a systems research approach in sustainable agriculture.

Professional Development Grants provide sustainable agriculture education and outreach strategies for Cooperative Extension personnel, NRCS staff, and others who work directly with farmers and ranchers to solve on-farm problems using sustainable agriculture solutions.

Graduate Student Grants are one of the few research opportunities open to Master's and PhD students majoring in sustainable agriculture.

Producer/Rancher Grants are for farmers and farmer groups to conduct research, marketing and education projects on their farms.

On-Farm Research Grants are conducted by agriculture professionals on one or more working farms to help their farmer clients find sustainable solutions to on-farm issues.

Sustainable Community Innovation Grants are for individuals and community organizations interested in linking sustainable agriculture with healthy economic community development.

For more information on Southern Region SARE grants and how to apply, log on to our website at [www.southernsare.org/Grants/](http://www.southernsare.org/Grants/). For other SARE regions/offices, visit [www.sare.org](http://www.sare.org)

*Kentucky*

**Booth #27**

***Kentucky State University College of Agriculture, Food Science and Sustainable Systems***

**Marion Simon, Kentucky State University, Frankfort, KY**

In addition to the Research, Extension and Aquaculture programs, Kentucky State University's College of Agriculture, Food Science & Sustainable Systems now offers undergraduate and graduate degree programs. Our new degree programs include Master's in Environmental studies, Aquaculture and B.S degrees in Agriculture, Food and the Environment. Other B.S degree programs will be opening soon. Other opportunities within the College of Agriculture include risk management education, alternative crops and enterprises, beginning farmer program, outreach to women and socially disadvantaged farmers.

Louisiana

Booth #28

***Southern University and A&M College System - Agricultural Research and Education Center***

**Dawn Mellion Patin, Southern University, Baton Rouge, LA**

Southern University Ag Center specialists and agents train residents to use new strategies during the small group settings of workshops, field days, one-on-one consultations, church meetings, Back-to-School summits, seminars, and agricultural leadership trainings. Parents are learning communications skills to strengthen their relationships in rearing children. By teaching gardening and plant science to inner city youth, a downtrodden area experiences the beauty of agriculture and free enterprise. The lessons Ag Center agents bring to after-school programs and public schools across the state also impact. The Southern University Ag Center is the only land-grant institution in the state dedicated to sustaining underserved citizens by teaching strategies for family management, food and nutrition, childcare, agriculture, parenting, youth development, and urban forestry. young students' food choices, health, behavior, and future outlook. By exposing families, farmers, and businesses to conferences, the Southern University Ag Center positions them to connect with like-minded parents, agricultural producers, and childcare providers, and anti-tobacco advocates, faith leaders, and business managers.

Booth #29

***Southern University and A&M College, Agricultural Research and Extension Center, The Small Farmer Agricultural Leadership Institute***

**Dawn Mellion Patin, Southern University, Baton Rouge, LA**

What is the Institute?

The Small Farmer Agricultural Leadership Institute is a two-year course of study specifically designed to guide small, socially disadvantaged, limited resource and/or minority farmers through the transformative process of becoming successful agricultural entrepreneurs.

Objectives

The overriding goal of the Small Farmer Agricultural Leadership Institute is to promote the sustainability of small family farms through enhanced business management skills and leadership development. The specific objectives of this project are to:

- Enhance understanding of agricultural infrastructure, state and federal government, agricultural economics, and effects of global agricultural on the U.S. economy;
- Increase the leadership, decision-making and analytical skills of participants;
- Improve participants' ability to manage a farm business in a competitive global economy;
- Develop and enhance the business management and marketing skills of limited resource farmers;
- Introduce producers to how decisions are made at the county, state, regional and national levels;
- Build an understanding of the public policy development process and prepare individuals to participate in the process;
- Improve their ability to communicate to both large and small groups, while increasing confidence in working with people; and
- Establish a basis for lifelong learning and development, by stimulating a desire for independent study and learning

#### How Are Participants Selected

A screening committee consisting of representatives from the 1890 institutions, community based organizations (CBOs) and small agricultural producers, will review application materials and select Institute participants. Participant selection will be based on the following:

#### Booth #30

### ***Global Food Security and Plant Biosecurity Outreach to Underserved Communities in Louisiana***

**Daniel Collins, Jason Preuett, Ashley Williams, and Lorraine Phillips  
Urban Forestry Program, University Agricultural Research and  
Extension Center, Baton Rouge, LA**

Louisiana's geographical location, climate and agricultural diversity make the region a high risk area for introduction of exotic plant pests and diseases of regulatory concern. Some plant pests and diseases that are threats to agriculture and renewable natural resources in Louisiana include citrus greening, sudden oak death, fruit flies, pink hibiscus mealy bug, and tropical soda apple. We have conducted a variety of outreach and educational programming on detecting exotic plant pests and diseases for underserved Communities in Louisiana. The exhibit will consist of a variety of hands-on interactive educational displays, publications, and videos of plant pests and diseases of national concern.

*Maryland*

## Booth #31

### ***Maryland Partners Reach Out To Small and Beginning Farmers***

**Jon Hall and Thomas Morgart, USDA Natural Resources Conservation Service, Annapolis, MD**

USDA Natural Resources Conservation Service Maryland fully supported the Agency's efforts to reach out to our small and beginning farmers and ranchers. This was done thru news releases, workshops and public speaking events. Significant new partnership groups targeted in this effort were the National Rural Coalition, National Association of Latino Farmers and Ranchers, and Accokeek Foundation. Support was received from the Office of Advocacy and Outreach 1890 Liaison University of Maryland Eastern Shore, Maryland Cooperative Extension, Maryland Association of Soil Conservation Districts, Maryland Agricultural Statistics. Some significant grants, agreements, presentations and workshops were conducted. Two examples are (a) Conservation Innovation Grant (CIG) with Maryland Association of Soil Conservation Districts to implement Farm Bill program presentation to specific groups communicated in Korean and Vietnamese and (b) Cooperative agreement with local Soil Conservation District to reach out to Plane Sect communities' Cooperative agreement.

## Booth #32

### ***University of Maryland Eastern Shore's – Small Farm Outreach Initiative***

**Berran Rogers, University of Maryland-Eastern Shore**

Socially disadvantaged and limited-resource farmers continue to face challenges (rise in operation costs, limited access to financial credit, lack of farm management skills, etc...) that make it difficult for them to own and operate farms successfully. In response to these challenges, the University of Maryland Eastern Shore established a partnership agreement with USDA-NIFA to implement a Small Farm Outreach Initiative (SFOI) here in Maryland and select counties along the Delmarva Peninsula. The primary purpose of the project is to help small-scale and underserved farmers become successful agriculture entrepreneurs and ensure they have access and equitable participation in USDA agricultural programs. To achieve this goal, the SFOI coordinates a variety of educational and outreach activities centered on the following objectives:

- Create awareness and participation among SDFRs in available USDA farm programs and other incentives offered by the state.
- Assist SDFRs and limited-resource producers with identifying and taking advantage of direct marketing strategies/tools to help them increase farm sales.
- Educate and train farmers in identifying and integrating profitable alternative enterprises through innovative and cost-efficient production practices.

The SFOI project team works with agencies, non-profit and community groups to: 1) recruit potential clients, 2) assess the current issues/interests among target audiences, and 3) plan a broad range of educational programs throughout the project coverage area. These programs are delivered via informational meetings, workshops, on-farm demonstrations, bus tours, and an annual small farm conference which attracts alone over 150 farmers and landowners each year.

*Mississippi*

**Booth #33**

***Farming, the Holistic Approach: Small Farm Outreach Training and Technical Assistance Project. (SFOP)***

**Carolyn Banks, Anthony Reed, Alcorn State University, Alcorn State, MS**

Limited-resource and socially disadvantaged farmers and ranchers in Mississippi are facing financial difficulties which have contributed to bankruptcy, foreclosures and stressful emotional conditions. Some of the major factors affecting the previously mentioned farmers are the lack of management skills, failure to sustain cash flow, racial discrimination, lack of USDA programs information and inability to make sounds decisions. SFOP provided one-on-one technical assistance in financial management, hands on production education, computer application to encourage electronic recordkeeping, and home budgeting to improve their quality of life, co-sponsored a small farmers conference that reinforced the training previously mentioned, and provided technical assistance in completing federal and state loan applications to enhance, establish and sustain a farming enterprise. During 2011, SFOP provided technical assistance to small Farmers and ranchers that help to spur \$1,677,500 dollars into Mississippi's Central Region farming industry with an average loan of \$15,000-\$30,000. Forty-eight thousands three hundred dollars (48,300) was provided from the Mississippi Small Farm Development Center to small limited- resource farmers with an average loan of \$5,000-\$10,000. Forty- Four farmers completed and received a certificate of completion for participating in Venders Borrowers Training classes to meet their USDA-FSA requirements. Five hundred and fifty-two (552) farmers gained knowledge of low cost conservation practices and five hundred and ninety-three farmers (593) received loan application training to qualify for the zero percent interest (0%) from the Alcorn State University Small Farm Development Center loan.

*New York*

**Booth #34**

***Cornell Small Farm Program***

**Anu Rangarajan, Violet Stone, Erica Frenay, Matthew Goldfarb, Fay Benson**

**Cornell University, Ithaca, NY**

The mission of the Small Farms Program is to support and encourage the sustainability of healthy, thriving small farms that contribute to food security, healthy rural communities, and the environment. To this end, we foster small farms focused research, extension programs, networking and. The Program achieves its goals through statewide Livestock Processing, Small Dairy, Beginning Farmer, Local Market Access and Growth, and Renewable Energy Work Teams. These teams include farmers, agriculture educators and service providers, agricultural non-profit organizations, and community members. Over 27,000 households receive research-based and farmer-generated information via the Small Farm Quarterly, a supplement to Country Folks magazine that we edit. Over 5,000 subscribers to our bimonthly email Small Farms Update get timely announcements of events, funding opportunities and educational resources or trainings. Our website [www.smallfarms.cornell.edu](http://www.smallfarms.cornell.edu) averages 3,200 hits per week. Since the Beginning Farmer website launched, we have had nearly 80,000 visitors, averaging 180 visits per day. In 2011 we offered 10 online courses with an average of 30 participants per course - including 4 new topics - to help beginning farmers continue their educational growth. Those who successfully complete a course will receive a certificate and are also eligible for Farm Service Agency (FSA) borrower training credit, which can improve eligibility to receive a low-interest FSA loan. We have distributed more than 6,000 hard copies of the "Guide to Farming in NY", in addition to copies downloaded electronically. The Guide has been adapted by numerous other states to inform farmers of important regulations and information

*North Carolina*

**Booth #35**

***Land Loss Prevention Project***

***Jeffrey Jandura, Land Loss Prevention Project, Durham, NC***

The Land Loss Prevention Project (LLPP) was founded in 1982 by the North Carolina Association of Black Lawyers to curtail epidemic losses of Black-owned land in North Carolina. The organization was incorporated in the state of North Carolina in 1983. The LLPP broadened its mission in 1993 to provide legal support and assistance to all financially distressed and limited resource farmers and landowners in N.C. facing challenges that may result in the loss or diminishment of their land and livelihoods. The LLPP has two focal units -- the Litigation Unit and the Sustainable Development and Environment Unit. The Litigation Unit performs debt restructuring for farmers in crisis and multi-faceted legal work designed to preserve land tenure for traditionally underserved individuals and families. Encompassed within these efforts is the work of the SmartGrowth Business Center, an internal resource, dedicated to assisting farmers through the provision of both legal representation and outreach on business law issues. The creation of SmartGrowth broadened the organization's approach to saving the family farm through the provision of proactive legal services and education focused on risk management and business



development. Provided services include direct legal assistance and education on business entity formation, contractual review, counseling concerning program availability and requirements, and the addressing of credit management. SmartGrowth's practice is primarily transactional. Through the Litigation Unit, the LLPP provides direct legal assistance and outreach in the following areas: agricultural; environmental; real property across a range of issues, including foreclosure defense; consumer protection; wills/estate planning; civil rights; zoning, municipal services, and related issues; bankruptcy as a last-resort alternative to foreclosures (farms and/or homes); and business/agricultural business issues. The Sustainable Development and Environment Unit helps family farmers and landowners explore sustainable agricultural alternatives and guides business development that is environmentally friendly and economically viable for rural communities. The Sustainable Development and Environment Unit works with state, regional and national coalitions that support sustainable agriculture practices, balanced development, and policy innovations. Having a multi-front strategy is foundational to meeting the needs of limited resource farmers and landowners. By addressing the immediate challenges confronted by the owners of farms, land, and homes and providing prophylaxis both in terms of proactive planning and policy advocacy and intervention, the LLPP continues to fortify small farms across North Carolina.

**Booth #36**

***Cultivating Accessible Agriculture through Assistive Technology  
(Agr-Ability)***

**Jimo Ibrahim, North Carolina A&T State University, Greensboro, NC**

North Carolina's agricultural industry, including food, fiber and forestry, contributes \$16.3 billion annually (NC Agricultural Advancement Consortium, 2009; Brown, 2008; ) to the state's economy, accounts for 22 percent of the state's income and employs over 20 percent of the state's work force. North Carolina (NC) is one of the most diversified agricultural states in the nation with the state's 52,913 farms producing over 80 different commodities on 8.4 million of the state's 31 million acres (US Department of Agriculture, 2009; NC Agricultural Advancement Consortium, 2009). Injuries or illness affects more than 200,000 North Carolina farm families.

According to the National Safety Council, agriculture is ranked as the most hazardous occupation in the US with fatality rates among agriculture, forestry, fishing, and hunting being higher than that of all other industries in 2007 (National Safety Council, 2009). In 2008, the US occupational injury incidence rate per 100 full-time workers in this sector was 5.3 on farms employing 11 or more workers, compared with 8.3 for all industries in the private sector.

The purpose of assistive technology program is to enable a high quality lifestyle for farmers, ranchers, and other agricultural workers farming with disabilities. Through education and assistance, AgrAbility help to eliminate or minimize obstacles that block success in production agriculture or agriculture related occupations. The purpose of this exhibition is to provide educational materials and information

for agriculture professionals on how they can better help and educate individual farming with disabilities.

*Oklahoma*

### **Booth #37**

## ***Understanding National Women In Ag Association's Service to Socially Disadvantaged Farmers***

**Cathy Johnson and Tammy Steele**

National Women In Agriculture Association (NWIAA) was founded and established February 2008, by Ms. Tammy Gray-Steele, who is the Executive Director. The organization is headquartered in Oklahoma City, OK. NWIAA is an agriculture outreach, fueled by sisterhood and diversity. NWIAA believes rural minority women have been often neglected; the lack of resources has stagnated rural development. NWIAA is the first minority woman owned and operated organization that provides innovative outreach education that attracts and sustains current and future generations with its innovative, spiritual and USDA certified education techniques. Our mission is to empower socially disadvantaged women in rural and urban America to gain available, local, and federal resources administered by the United States Department of Agriculture. For this purpose, through education, development and networking, as bonds of sisterhood are created among all women. Our vision is to provide vital opportunities for rural and urban communities to equip for tomorrow while engaging in today, and make investments in society (state, region and beyond), which will move the United States of America toward an authentic, sustainable future. The following are NWIAA's main objectives:

1. To develop locally grown food security systems in underserved communities (food deserts).
2. Ensure that future generations will have opportunities and are respected as experts and professionals in the industries of agriculture/farming through USDA programs.
3. Help to increase the number of minority participants in the agriculture/farming industry.
4. To promote character, health and income from the ground up!

*Oregon*

### **Booth #38**

## ***Oregon State University Extension Small Farms Program***

**Small Farms Program Faculty & Staff**

The Oregon State University Extension Small Farms Program serves commercial small farm entrepreneurs as well as non-commercial small acreage landowners. Our focus embraces both organic/biological and conventional farming systems and emphasizes three areas:

- Small Acreage Stewardship—Addressing land management and soil and water quality for non-commercial small acreages.

- Commercial Small Farms—Addressing high value horticulture, livestock and poultry, and alternative crop production emphasizing organic and pasture based systems and specialty and niche production. Value-added product development is often integrated with production.
- Community Food Systems—Addressing alternative and specialty marketing through creation and enhancement of local and regional food systems and farm direct marketing channels. Farmers markets, agritourism, farm to retail and institution sales are special emphasizes.

The Small Farms Program has Extension faculty based in the northern and southern Willamette Valley, and southern Oregon Coast.

*Tennessee*

**Booth #39**

***Tennessee State University Cooperative Extension***

**Solomon Haile, Alvin Wade, and Fitzroy Bullock, Tennessee State University**

Tennessee State University (TSU), an 1890 land-grant university, provides a wide range of agricultural education and outreach services to area farmers in Tennessee through our cooperative extension network system. This system is comprised of both on-campus faculty specialists, and (30) county-level extension offices staffed by one or more experienced agents charged with providing timely, practical, research-based information to agricultural producers, small business owners, youth, consumers, and others active participants in Tennessee’s agricultural and forest production communities.

**Booth #40**

***Unusual Neglect-Tolerant Plants for Home Food Production***

**Adam Turtle FLS/Earth Advocates Research Farm, Earth Advocates Research Farm, Summertown, TN**

Exhibit will consist of captioned photographs and samples of plants that our performance trials have indicated are good candidates for inclusion in home landscapes and farmsteads. Among them will be several species of temperate bamboos as well as containerized trees and shrubs. Potential plant uses will include fuel, fiber, fencing (living) as well as food production for both humans and livestock. Adam Turtle will be available (when not attending or presenting oral sessions) to answer questions and discuss virtues and limitations he has observed in years of performance trials in both Overton and Lawrence Counties in Tennessee (USDA zones 5, 6, or 7 depending on the winter, summers usually hot and frequently dry).

**Booth #41**

***Helping Farmers Develop Value-Added Enterprises***

**Hall Pepper, University of Tennessee Extension—Center for Profitable Agriculture**

As a department in UT Extension, the Center for Profitable Agriculture provides educational programming and technical assistance to Tennessee farmers interested in a value-added enterprise to improve farm income. Evaluating the costs of starting a new enterprise, navigating regulatory issues and identifying a potential market are some of the many challenges farmers may face when considering a value-added enterprise. Specialists at the Center may be able to help in the evaluation and development process through individual enterprise analysis, educational workshops, conferences, publications and planning tools.

**Booth #42**

***Tennessee Department of Agriculture***

**Jon Frady, Tennessee Department of Agriculture, Nashville, TN**

Jon.Frady@tn.gov

www.picktnproducts.org

www.tn.gov/taep

*Washington*

**Booth #43**

***WSU Small Farms Team***

**Doug Collins and Marcy Ostrom, Washington State University**

The Small Farms Team works with communities and individuals across Washington to foster a profitable farming system, to promote land and water stewardship, and to ensure that all Washingtonians have unrestricted access to healthy food. Washington State University Small Farms Team provides research-based information and educational programs for farmers, consumers, decision-makers, and others involved in local food systems. The team is a statewide affiliation of professionals from WSU, state agencies, and non-governmental organizations.

Our primary goals are to:

- Build public support for agriculture
- Preserve Washington farmland for food and fiber production
- Help farmers adopt practices that are sustainable- economically, socially and environmentally
- Unify farmers and consumer in developing local markets and community food access

The Small Farms Program is a program of the Center for Sustaining Agriculture and Natural Resources in WSU Extension and the College of Agricultural, Human, and Natural Resource Sciences. The program focuses on education resources for farmers, outreach to communities, and team-based research with farmers.

## ***INTERNATIONAL***

*Austria*

**Booth #44**

***Orthoimages as Fundamental of GIS based ICT Supporting Agriculture-Forestry-Environment including Smallholder Farmers***

**DI Walter H. Mayer, PROGIS Software GmbH, Postgasse 6,9500 Villach, Austria**

Today we find a huge gap between the know-how of the average farmer in a quick changing world and the enormous growing scientific know-how of agro- and environment researcher. Further, ICT is still adopted poorly in agriculture and forestry and there are still low possibilities to get access to data needed for daily management. In 2011 Microsoft launched their “Global Ortho-Project”; in the meantime they have covered the entire USA and large parts of Western Europe. The high quality images have a resolution of 30 cm which means they form the best fundament for planning and controlling rural activities. PROGIS is specialised in developing GIS-software (Geographic Information Systems) respectively ICT tools for agriculture and forestry, for planning and control of food/feed/biomass production processes, as well as for rural logistics, environmental caretaking and sustainability. With a wide range of applications and in cooperation with further technology providers and scientists as consultants we assist farmers and foresters as individuals or in groups as well as service providers. To foster small holder development we advocate the installation and acceptance of advisory/extension services and offer in a holistic approach the following: Images and GIS as base for land parcel information systems. Agro-applications for planning, calculation, control, documentation, traceability and soil management, further to generate business plans for banks and data for insurance companies for IT experts and advisors to handle up to 250 and more farms depending on farm structure; agro-sensor

data from weather stations and soils sensors as decision support, and consulting for rural area management tasks. Education and training are also offered.

# *SUCCESS STORIES*

*DISTRICT OF COLUMBIA*

*Booth #1*

*High Tunnels for Socially Disadvantaged Producers:*

*A Farm Bill Success Story*

*Lorette Picciano & Tracy Lloyd McCurty*

*Rural Coalition, Washington, DC*

Rural Coalition (RC) is excited to share how advocacy efforts have created new opportunities for socially disadvantaged and other farmers while promoting environmentally sound agricultural practices, and how producers are now using these opportunities. High tunnels provide important benefits including extending the growing season, preventing pest infestations without reliance on chemicals, and using less energy than greenhouses.

RC, anticipating that socially disadvantaged and other producers would benefit greatly from high tunnels, built an advocacy campaign to secure USDA support. The Farm and Food Policy Diversity Initiative, coordinated by RC, successfully worked with the House and Senate Agriculture Committees to develop key 2008 Farm Bill language. The final version of the Bill allowed Natural Resources and Conservation Service (NRCS) to pay up to 90% of the cost of conservation practices for socially disadvantaged (and beginning) producers with an advance of up to 30% to allow producers to afford the costs for the improvements they wanted for their land.

Then in 2009, Rural Coalition, along with several partners, submitted comments to NRCS that promoted adding High Tunnels to the list of conservation practices approved for federal funding in the Environmental Quality Incentive Program (EQIP). That year, NRCS approved a pilot program to assess the conservation benefits of high tunnels. As a result, more than 4,500 producers benefit from high tunnels, including many socially disadvantaged producers who have now returned to or accessed USDA services for the first time as a result of the highly popular and beneficial program.

*Booth #2*

*Farm to School:*

*Marketing Opportunities for Small Farms and Processors*

***Matthew E. Russell, USDA - Agricultural Marketing Service, Washington, DC***

Over the past decade, interest in local and regional food has grown considerably throughout the United States. This holds true for K-12 school meal programs, where a growing number of communities are establishing farm to school initiatives to better integrate school food and educational programs with local and regional food systems. In response to this growing demand for farm to school initiatives, the USDA formed, in 2010, a multi-agency Farm to School Team (Team). In 2010, the Team visited 15 school districts in nine areas around the country, which represented various demographics and implementation stages of a school's Farm to School efforts. During the visits, the Team met with school district administrators, local farmers, distributors, local and state authorities, students, teachers, parents, and community partners to analyze and assess variables that support or deter Farm to School activities, both from the school and farmer perspectives, and the effects the activities have had on the school and the community.

The USDA Farm to School Team will provide a success story of small farms accessing the school food market, selling fresh produce and meat products to neighboring school districts.

***Booth #3***

***“Cultivating Opportunities with FSA”***

***James Radintz, USDA-Farm Service Agency, Washington, DC***

With an assortment of technical expertise and a variety of financing programs, the Farm Service Agency's (FSA) Farm Loan Programs is committed to serving family farmers and ranchers to promote, build, and sustain family farms in support of a thriving agricultural economy. FSA's loan programs are designed to help family farmers and ranchers obtain loans and loan guarantees, and conduct business planning. In many cases, those in underserved communities need additional financial and business acumen to qualify for commercial credit. Others have suffered crippling financial setbacks and are in need of additional resources with which to establish and maintain profitable farming operations. FSA has specially targeted loan funds for Beginning Farmers/Ranchers and Socially Disadvantaged Applicants (minorities and women), in addition to 3 loan programs only available to beginning farmers and SDA applicants. Of particular interest to underserved communities, such as immigrant, small, beginning, and urban farmers, is FSA's ability to provide microloans, which is not widely known.

The complexities of applying for, obtaining and maintaining Federal financing can be daunting. This session will address the areas identified as most difficult for loan applicants, such as eligibility and feasibility criteria and what to do if faced with an adverse decision. Attendees will be provided with an Agency and program overview interspersed with example stories of those we've assisted culminating with a round-table discussion based on the questions and interests of the workshop attendees.



## *Booth #4*

### *NRCS Success Stories*

#### *Vivian Dixon*

*USDA-Natural Resources Conservation Service, Washington, DC*

#### Outreach Success Stories

- Macon County, Georgia – John Lowe

John Lowe had been watering his 95 pecan trees by hand. Three times a week he would fill up a 300-gallon water tank and drive out to the field. For five hours he would water his trees with a five-gallon bucket.

- Through the EQIP program, NRCS was able to offer a 90 percent cost-share, and he began working with the local NRCS district conservationist to develop a whole-farm irrigation plan.
- Now instead of 15 hours a week, John spends about five minutes watering his trees. Other farmers in the area are seeing his results and applying for NRCS programs for their lands.

- Warren County, Mississippi – Robert Short

- Robert Short has been using organic practices on his farm for years -- before he even knew what organic meant. It's what his grandfather did 60 years ago. They couldn't afford fertilizer, so they cleaned out the chicken houses and spread it across the fields each year.
- Now with NRCS assistance, Robert uses horse manure and crop rotation to keep his four-acre farm running smoothly.
- He will soon be a USDA certified-organic farmer and is working with two local grocery stores to carry his produce. Now his grandchildren are learning the family business.

- Sevier County, Arkansas – Lee Pauley

- Lee Pauley is an 84-year old farmer living in Sevier County, Arkansas. He plants and harvests produce to sell within local farmers' markets.

- Thanks to an EQIP irrigation project on his property, keeping vegetables watered on his farm has become much easier. Instead of using a bucket to water his crops, Lee was able to install an irrigation well – at a 90 percent cost-share rate.

*FLORIDA*

*Booth #5*

***A National Strategy For Enhancing the U.S. Goat Industry***

***Angela McKenzie-Jakes, Florida A&M University/Cooperative Extension Program***

Today, goat production continues to be one of the fastest growing industry in the U.S.

Persistence among ethnic consumers in maintaining their religious or cultural practices has

increased demand for goat meat. Because of demand, many small and limited resource producers are raising goats as an alternative source of income. However, producers in many cases still lack the necessary skills and knowledge to adequately produce quality meat goat products on a consistent basis to meet demand while sustaining a profit.

To address these issues, Florida A&M University (FAMU) submitted a proposal to Southern SARE in 2008 to provide educators, producers and students with research-based information on goat production, management and marketing. In 2010, FAMU collaborated with thirteen 1890 and three 1862 institutions, as well as community based organizations and state and federal agencies to host the first National Goat Conference of its kind. Survey instruments and questionnaire forms were developed to determine the demographics of the audiences, the new skills and knowledge they gained while attending the conference and to determine which new technologies the producers planned on adopting on their farms once they returned home. After the conference, sixty-eight percent of the producers felt extremely confident about applying their new knowledge and skills to their farms. Ninety-four percent of the conference attendees stated they would attend the conference again. Other results of the conference included the establishment of a National Goat Consortium to address critical issues facing the goat industry through research and extension.

*IOWA*

*Booth #6*

***Sustainable High Intensity Mixed Produce Production On Slopes In Excess of 20 Degrees (about 4 1/2 vertical to 12 horizontal)***

**Carl Glanzman, PE, Manager, Nishnabotna Naturals, Certified USDA Organic Producer of Vegetables and Fruits, Oakland, IA**

This farm consists of 15.5 acres out of a 240 acre Midwest farmstead. The bulk of the property is in conventional corn:soy rotation, rented to conventional farmers. The organic farm now uses 2.5 acres of that 15.5 for high intensity produce production in terraced open field beds. The site is at the top of a major drainage divide on a ridge line, subject to sustained winds in the 10-35 mile/hour range over 4 months annually.

Water is captured, stored from snowmelt and rainfall and made available to the mixed greens, root crops, herbs and gourmet vegetables grown on the site. The key is sod terrace berms as high as the low lip of the upslope edge of the terrace and good elevation control, allowing true farming of the contour. Terraces are wide enough for tractor and tractor width implements. The downslope berm provides a windbreak, protecting soil from wind erosion.

Intensive winter season planting of cover crops has enriched soil organic matter to the point that the clay soils are able to percolate and hold water well. This small acreage supports a CSA, sales to a 500 share CSA, restaurant sales and farmstand/farmer's market sales.

*KENTUCKY*

*Booth #7*

***The Third Thursday Thing and the Small, Limited-Resource, Minority Farmers Conference, Making a Difference***

***Marion Simon, Kentucky State University, Frankfort, KY***

The Kentucky State University "The Third Thursday Thing" and the Small, Limited-Resource, Minority Farmers Conference are signature programs for the University, the College of Agriculture, Food Science and Sustainable Systems, and the Cooperative Extension Program. Putting researchers, Extension professionals and paraprofessionals, USDA and State Agencies, small farmers and non-profits together in a learning environment creates a sense of belonging and community. Farmers and professionals share ideas and work to answer questions and problems. As many of Kentucky's farmers lost their tobacco income during this time, these programs were instrumental in introduced them to alternative enterprises, new production techniques, new marketing opportunities, and helped them to develop support networks. Most of all, it gave them HOPE to survive into the future.

This presentation will cover six (6) success stories that are the direct result of farmers participating in both the Small, Limited-Resource, Minority Farmers Conference and The Third Thursday Thing. Some of the farmers were facing bankruptcy, some needed to replace their dwindling tobacco income, and some were looking to become involved in new production systems. These six farm families have interesting, and varied reasons for seeking Kentucky State University's Cooperative Extension Program for assistance. They include women, minority, small-scale, and refugee farmers, plus youth.

*Booth #8*

***Fresh Start Growers' Supply***

***Steve Paradis, Louisville, KY***

Fresh Start Growers' Supply is a food-focused, organic, and sustainable farm and garden supply located in Louisville, Kentucky. We specialize in assisting urban, backyard growers to become food independent. We are located in downtown Louisville. We host a weekly farmer's market, conduct workshops, and create local food celebration events. We make and distribute compost tea. We grind our own chicken feed. We help our customer become successful growers. The reason we think our story has relevance to this conference: We need to recreate an independent, fair, and locally-based food system, that is partnered with small, family farms. Please visit our website at [www.freshstartgrowers.com](http://www.freshstartgrowers.com) to learn more.

*LOUISIANA*

*Booth #9*

***Small Farmer Agricultural Leadership Institute***

***Dawn Mellion Patin and Zanetta Augustine, Southern University, Baton Rouge, LA***

Formal training and instruction in leadership development was not offered to small farmers in this country, until the Southern University Ag Center established the Small Farmer Agricultural Leadership Institute in 2005.

The Institute promotes small farm sustainability by enhancing the decision-making and leadership development skills. As the participants work through eight leadership principles, they become better leaders while enhancing farm management and production skills. During the course of study, participants attend rigorous, interactive, experiential learning workshops and attend farm and agricultural business tours.

To date, 115 small farmers have participated in the training classes. The graduates, are assuming leadership positions in their communities and the agricultural sector at large and are serving on national, regional and local advisory boards, taskforces, councils and committees. Three graduates have been appointed to national small farm advisory boards by The Honorable Tom Vilsack, Secretary of Agriculture. Several graduates have been asked to be speakers and presenters at national conferences as small farm experts. They are even serving as reviewers on USDA competitive grants programs. Their farms are being used as model demonstration farms and are creating opportunities for growth, expansion and enhanced development and prosperity for other small farmers. The adage that states when you teach a man to fish, you feed him for life has proven true with the participants as demonstrated by their efforts to assist and serve other small farmers. Evidently, these graduates have been fed for life as a result of their hard work in the Institute.

## MARYLAND

### *Booth #10*

## **MARYLAND PARTNERS REACH OUT TO SMALL AND BEGINNING FARMERS**

*Jon Hall, USDA-NRCS, Annapolis, MD*

USDA Natural Resources Conservation Service Maryland fully supported the Agency's efforts to reach out to our small and beginning farmers and ranchers. This was done thru news releases, workshops and public speaking events. Significant new partnership groups targeted in this effort were the National Rural Coalition, National Association of Latino Farmers and Ranchers, and Accokeek Foundation. Support was received from the Office of Advocacy and Outreach 1890 Liaison University of Maryland Eastern Shore, Maryland Cooperative Extension, Maryland Association of Soil Conservation Districts, Maryland Agricultural Statistics. Some significant grants, agreements, presentations and workshops were.

- Conservation Innovation Grant (CIG) with Maryland Association of Soil Conservation Districts to implement Farm Bill program presentation to specific groups communicated in Korean and Vietnamese
- Cooperative agreement with local Soil Conservation District to reach out to Plain Sect communities

## MASSACHUSETTS

### *Booth #11*

## **USDA-OSDFR (2501) Program and NRCS-EQIP Helped Massachusetts Socially Disadvantaged Farmers Extend the Growing Season with HIGH TUNNELS**

**Maria Moreira, University of Massachusetts, Amherst, MA**

As a result of USDA 2501 program, grant awarded to the University of Massachusetts Amherst (UMASS), NRCS Environmental Quality Incentives Program (EQIP) *High Tunnel Pilot Project* and Rural Coalition outreach support, farmers at FMF participated in the, "Know Your Farmer, Know Your Food" initiative, eight farmers constructed and are using their season extension High Tunnels. The 9<sup>th</sup> farmer will complete her High Tunnel by the end of September 2012. This is a monumental achievement for these beginning farmers who work very hard to learn how to grow crops from their native country as well as new crops that are popular at the many farmers markets, and chain stores in Massachusetts," where they sell their crops. A seasonal high tunnel is a greenhouse-like structure, at least six feet in height, which modifies the climate inside to create more favorable growing conditions for vegetable and other specialty crops grown in the natural soil beneath it. The climate inside the high tunnel

is modified by the protection of the structure alone, without the use of heating or ventilating equipment. These structures enable farmers to extend their growing season.

One of the objectives of the support received was to provide access to USDA programs while building farmer capacity on crop production and marketing to operate independent farming enterprises. Thus the outreach focused primarily on the farmers at the Flats Mentor Farm (FMF) located in Lancaster, MA. FMF assists and supports small farmers of diverse ethnic backgrounds with the land, farming infrastructure and marketing assistance needed to promote and sustain successful farming enterprises. This 2012 growing season FMF hosts 72 farmers from Laos, Burundi, Kenya, Kongo, Ghana, Nigeria, Liberia, Tanzania, Brazil as well as from US.

*MISSOURI*

*Booth #12*

***Innovative Small Farmers' Outreach Program (ISFOP): Lincoln University Cooperative Extension (LUCE)***

***Paul B. Kamalendu, Lincoln University Cooperative Extension, Jefferson City, MO***

***The Story of Leroy Booker, a Beginning, Underserved Minority Farmer***

Traditionally underserved populations in Missouri are underrepresented in small farming. Perhaps because of social changes in the recent past many minorities have lost their connections to growing food. Consequently, many are unaware of the USDA programs, Extension programs, where to go for information and who can help them in pursuing dreams of small farming. Encouraging and supporting the involvement of minorities in food production deepens community ties across ethnic lines, reinvigorates our identity as the melting pot of the world, and provides opportunities for healthy food.

For the past three years, the Farm Outreach Workers (FOWs) from the Innovative Small Farmers' Outreach Program (ISFOP) of Lincoln University Cooperative Extension (LUCE) have sought out the individuals from the minority community who are interested in learning more about growing food for home consumption and for profit. The FOWs help their traditionally underserved clients with assessing their available resources, channeling their farming ideas and identifying resources that may benefit them.

Leroy Booker grew up on a typical urban lot in Kansas City. Leroy's journey started in 2011 when he borrowed a tiller and bought some seeds at a local farm store. Jim Pierce, the FOW for the Platte and Clay Counties, happened to be at the farm store to pick up a few supplies. He noticed Leroy asking gardening questions to the store clerk. Jim joined the conversation and soon realized that Leroy needed a lot of help with his new venture. Jim introduced himself to Leroy and offered his assistance to get him started. At Jim's encouragement, Leroy signed up for the "Organic Production Systems Workshop for the Beginning Farmers" offered by the University of Missouri Extension. Thus began Leroy's journey into a new world of "farming".

Jim explained to Leroy the availability of various USDA programs, and encouraged him to contact the local Natural Resources Conservation Service (NRCS) field representative to make an assessment of his farm land and to learn about the other NRCS programs and how he could benefit from them.

In the fall of 2011, Jim assisted Leroy in developing and submitting a Sustainable Agriculture Research and Education (SARE) Farmer/Rancher grant proposal. Although his proposal was not funded, the exercise helped motivate him to pursue the project on his own. He now has a small plot of table grapes that he has developed using sustainable practices.

### *Booth #13*

#### ***Innovative Small Farmers' Outreach Program (ISFOP): Lincoln University Cooperative Extension (LUCE)***

***Paul B. Kamalendu, Lincoln University Cooperative Extension, Jefferson City, MO***

#### ***Cutting out the Hay***

Sam Harris of Wentzville, Missouri needed a hay barn, or so he thought. He had longed for a dry place to store his purchased and home-grown hay. Sam maintained enough of it annually to sustain his cow herd through the extremes of summer and winter when the pastures had typically stopped producing. He wondered if there were any cost-saving resources and/or funding opportunities that would aid him in the construction of a hay barn! So, he contacted David Price, the Farm Outreach Worker (FOW) for St. Charles and Lincoln Counties with the

Innovative Small Farmers' Outreach Program (ISFOP) of Lincoln University Cooperative Extension (LUCE).

Per Sam's request, David made a thorough search for information related to loan and/or funding options for the construction of an on-farm hay storage facility. Sam was not particularly enthused by any of the options. So, Sam asked David if there were any other ways that a man could sustain a cow herd during periods of pasture dormancy. David recommended that Sam could consider installing a managed grazing system, and that he could qualify for the cost-share funding available through the United States Department of Agriculture/Natural Resources Conservation Service's (USDA/NRCS's) Environmental Quality Incentives Program (EQIP) program.

David Price assured Sam that by implementing a managed grazing strategy he could extend the grazing season well into the winter months, and thus make a sizable reduction in the amount of hay he would need to feed his animals. Sam learned that managed grazing systems have many other advantages too, such as increasing forage yield and diversity, promoting the build-up of soil organic matter and increasing water retention, controlling soil erosion, managing parasites in animals, and enhancing wildlife habitat.

After taking a tour of David Price's personal farm, Sam was able to observe first-hand the benefits of a fully implemented managed grazing system. He was totally sold on the idea and hurried to his county's USDA Service Center to apply for assistance. Several weeks later a Resource Conservationist from the NRCS met with Sam and David on the Harris farm. The three collaboratively drew up a prospective grazing system for Sam's 102-acre grass farm. After a few more meetings, Sam eventually signed a

contract with the NRCS for the construction and implementation of a managed grazing system on the Harris' farm.

The construction of Sam's grazing system was completed in July of 2011. Because of the collaboration between ISFOP and the NRCS, Sam Harris fed 75 percent less hay during the 2011/2012 winter than he had just one year prior. Also, with the cost-share assistance provided by the NRCS, Sam saved approximately \$19,000 that he would have had to invest otherwise in a hay barn. Early in the summer of 2012 Sam thanked both ISFOP and the NRCS saying "My pastures now look great nearly year round, my herd has become easier to manage, my workload has been lightened, and I have more money in the bank".

*NEW YORK*

### *Booth #14*

## *The Northeast Beginning Farmer Learning Network*

*Anusuya Rangarajan, Erica Frenay and Michelle Striney*

*Cornell University, Ithaca, NY*

There are numerous on-the-ground efforts to support beginning farmer (BF) development around the Northeast. Many of these operate in isolation, with little chance to formally share their own experiences in supporting BFs, and to learn together what works, what does not, and brainstorm strategies to create long term sustainability for these efforts. In response, we created the Northeast Beginning Farmer Learning Network, to foster just such a learning environment among BF programs active in the region. Using on-line surveys, we identified specific educational and training needs of BF-serving organizations in the Northeast. Based upon their priorities, we organized annual face-to-face training designed to foster an open networking space to learn, improve approaches and address critical issues affecting these organizations and the success of BFs in the Northeast. Example topics have included effective evaluation strategies, farm financial management tools, using social networking and media effectively, incubator farm design, assessing economic impact of BFs on their communities, farmer-to-farmer learning groups, US farm policy and BFs. Between the annual face-to-face meetings, we have hosted a series of webinars called 'Lunch Time Learning.' These 1.5 hr sessions have allowed us to reach out to other BF organizations around the country to focus on topics such as BF competencies, USDA BF services, designing delivery of full BF services (one-stop-shopping), land linking services, and cultural competencies for working with minority and underserved BFs. 100% of our participants have reported improving their skills to serve BFs and expanding their awareness of other Northeast organizations also serving BFs. Our Network resources and webinars can be found at <http://nebeginningfarmers.org/trainers/>.



*OKLAHOMA*

*Booth #15*

***Understanding National Women In Ag Association's Service to Socially Disadvantaged Farmers***

***Cathy Johnson and Tammy Steele , National Women in Agriculture, Oklahoma City, OK***

National Women In Agriculture Association (NWIAA) was founded and established February 2008, by Ms. Tammy Gray-Steele, who is the Executive Director. The organization is headquartered in Oklahoma City, OK. NWIAA is an agriculture outreach, fueled by sisterhood and diversity. NWIAA believes rural minority women have been often neglected; the lack of resources has stagnated rural development. NWIAA is the first minority woman owned and operated organization that provides innovative outreach education that attracts and sustains current and future generations with its innovative, spiritual and USDA certified education techniques. Our mission is to empower socially disadvantaged women in rural and urban America to gain available, local, and federal resources administered by the United States Department of Agriculture. For this purpose, through education, development and networking, as bonds of sisterhood are created among all women. Our vision is to provide vital opportunities for rural and urban communities to equip for tomorrow while engaging in today, and make investments in society (state, region and beyond), which will move the United States of America toward an authentic, sustainable future.

The following are NWIAA's main objectives:

1. To develop locally grown food security systems in underserved communities (food deserts).
2. Ensure that future generations will have opportunities and are respected as experts and professionals in the industries of agriculture/farming through USDA programs.
3. Help to increase the number of minority participants in the agriculture/farming industry.
4. To promote character, health and income from the ground up!

*TENNESSEE*

*Booth #16*

***Technology: A Catalyst for Small Farmers' Extension Education in Virtual CoffeeShop***

***Solomon Haile, Tennessee State University, Nashville, TN***

The internet is becoming an increasingly vital tool in the current information society. Providing practical and useful research-based extension education for small farmers in the information age requires a paradigm shift in delivery method with new

efforts by cooperative extension programs. Tennessee State University (TSU) is offering a new innovative way to keep small farmers up with cutting-edge and timely topics in extension educational program areas by presenting the “TSU Extension Virtual Coffee Shop”– monthly public outreach educational webinars. The program uses Wimba classroom to deliver an extension education that covers various topics in the areas of Agriculture and Natural Resources, Family, Community and Nutrition and 4-H Youth Development. Wimba classroom is a live, virtual classroom environment with robust features that include audio, video, application sharing and content display, and MP4 capabilities. Future uses of Wimba in this program will include small meetings and trainings, for statewide, multi-state and international collaborations. Through “TSU Extension Virtual Coffee Shop”, the program will help Extension personnel accomplish their work in creative and diverse ways and to see growth in extension educational program. The technology is advantageous because it can be accessed from most personal computers, and it’s easy to use. The program anticipates reducing cost of travel by extension specialist and agents as well as limiting Extension personnel carbon foot print by keeping tons of carbon dioxide from being emitted. This undertaking is novel not only for 1890 institutions but the land grant system overall.

## Booth #17

### ***The New Century Farmer Program: Nurturing the Entrepreneurial Spirit and Personal and Professional Growth of Young People Who have Committed to the Career of Farming***

***John C. Ricketts , Tennessee State University, Nashville, TN***

According to Mishra, Wilson, and Williams (2009), more than half of present-day farmers are likely to retire in the next five years, so the need for youth to enter farming is dire. The purpose of this presentation is to make participants aware of the impacts of a program, managed by the National FFA Organization for the following purposes: (1) develop a continual program of activity and information focusing on farming as a career; and (2) nurture the entrepreneurial spirit and personal and professional growth of young people who have committed to the career of farming. The New Century Farmer (NCF) conference originated at DuPont in 1997 and Pioneer became a partner in 1999. The role of FFA had been limited to technical assistance and support until 2000. Due to staffing reductions at DuPont, the organization asked FFA to assume leadership for NCF. NCF helps FFA further realize its mission statement by providing 50 students pursuing careers in farming cutting edge information about the industry. By networking with industry experts, presenters and each other, NCF participants discuss topics ranging from the global marketplace to farm financing, consumer trends to managing risk. Participants are exposed to the latest developments in agricultural technology and attend field tours and workshops regarding personal and professional development and team building. The program just finished a survey of 13 years of alumni perceptions, documenting the impacts of the program, which will also be shared as part of the success story.

## Booth #18

### ***Voices from Our Community Garden***

## Mary Mafuyai-Ekanem<sup>3</sup>, Enefiok Ekanem<sup>4</sup> and Arvazena Clady<sup>5</sup>

Tennessee State University community garden is a research-based extension education that celebrates its second year in 2012. It began as a lunch dream of a few extension specialists and scientists desiring to involve the community in learning, growing and sharing fresh seasonal produce. Poster documents the impacts of the community garden on participants, university and the community. Two-year data from one-on-one conversations, interviews, project evaluations and non-intrusive observations of gardener-to-gardener, **gardener**-to plant, as well as gardener- to-visitor interactions are presented.

<sup>1</sup> Consulting Economist, LaRun & Associates

<sup>2</sup> Research Professor, Department of Agricultural & Environmental Sciences, Tennessee State University

<sup>3</sup>Extension Specialist, Department of Agricultural & Environmental Sciences, Tennessee State University

TEXAS

### *Booth #19*

#### *“Weeds Can Be Valuable*

#### *Amelia Soto-Sanchez, University of Texas Pan-American*

The Direct Marketing Initiative for Beginning Farmers and Ranchers in South Texas has been assisting their target audience of socially-disadvantaged, immigrant and limited-resource beginning farmers by helping them to successfully direct market their agricultural produce and products. The majority of the program participants are women (82%), growing vegetables in their home plots and selling the produce their families don't consume.

One-on-one farm visits are being conducted to review the methods and techniques learned at workshops. This has proven very helpful to participants. As an example, one Hispanic woman who is becoming a very successful grower of gourmet vegetables and exotic fruits was concerned about 'weeds' in and along her small farm plot. These 'weeds' were wild-growing purslane (*portulaca oleracea*) or "verdolaga" and prickly

pear (*Opuntia ficus-indica*) or "nopales". During a one-on-one farm visit, this beginning farmer was advised that these 'weeds' could be successfully sold at their local farmers market.

At the Farmer's Market "verdolaga" and "nopales" were sold in bags of ½ lb. and 1lb. at \$2 and \$4, respectively. Recipes and nutritional facts handouts were given to the customers along with tasting samples of cooked products, creating a great customer response. Customers that purchased these products said that it reminded them of their childhood when their grandmothers prepared meals from

scratch with fresh vegetables. The grower increased her knowledge about these plants and marketing tactics, and improved her produce sales by 40%. With the right training and assistance, ‘weeds’ can become a valuable resource.

WASHINGTON

*Booth #20*

***Changing the Landscape of the Rural Agriculture; How County Government and the Farm Community Came Together to Change the Future of Agriculture***

***Linda Neunzig, Snohomish County Agriculture Coordinator, Everett, WA***

In 2002, when Snohomish County Executive Aaron Reardon came into office, the business of farming was vanishing in our county. Farmers were selling their land to developers for subdivisions; young farmers were nowhere to be found. Trust in county government was weak and regulations did not support farming. Executive Reardon knew the strong history of farming in our community and the importance of a secure food source. Shortly after taking office he invited area farmers together and asked: “What can we do as county government to help you be economically viable?” and, “What are the regulations that stand in your way?” This gathering was our first annual Focus on Farming Conference in 2003. The information gathered from the farmers was compiled in the Ag Action Plan. From this plan, a committee was formed that included over 50 community members who met over an 18-month period to distill the items identified from the conference into workable action items. These action items, documented in the *Snohomish County Agriculture Economic Development Action Team Report*, provided the blueprint for our county’s success. By following the recommendations of our farming community, we successfully changed the farming economy and the outlook for farming. Snohomish County now has more farmers and more land in production, and agriculture in our county is strong and growing financially. In addition, Snohomish County government has earned the trust of the farming community. We would be proud to highlight our accomplishments at this year’s National Small Farm Conference

## **Agricultural Alternatives: The Small-Scale and Part-Time Farming Project at Penn State**

**Jayson K. Harper and Lynn F. Kime**

**Dept. of Agricultural Economics, Sociology, and Education**

**The Pennsylvania State University**

**University Park, PA 16801**

Since its inception in 1992, the Small-Scale and Part-Time Farming Project has focused on providing educational materials to assist producers through the complexities of enterprise selection. The Agricultural Alternatives publication series, which now contains 59 publications, has strived to help producers analyze production alternatives by providing a balanced assessment of crop and livestock enterprises that might be suitable for small-scale and part-time farming operations. Most of the leaflets offer an introduction to a specific enterprise and cover important issues including marketing, production, regulations, risk management, and enterprise budgeting. To support the enterprise oriented publications, a set of publications covering agricultural business management topics including planning, financing, fruit and vegetable marketing, cooperatives, diversification, insurance, enterprise budgeting, and managing a roadside stand have also been developed. There are also two publications on irrigation and another on organic vegetable production.

County Extension offices regularly receive inquiries from clientele for information about how to produce specific crops or livestock. The Agricultural Alternatives series is frequently used by county educators as a first step to assist their clients with this process. With the number of small farms expanding each year (Table 1), these clients need complete and balanced information about the enterprise they are considering. Existing producers who are considering diversifying their operations or have underutilized land use the publications when researching their options. Although the publications have been developed with Pennsylvania's small-scale and part-time farmers in mind, these publications are widely used with all types of farm audiences and are also of interest to the general public. These publications are also extensively used in the extension programs conducted in neighboring states and are accessed both nationally and internationally through the Internet. Several of these publications have been used as part of the curriculum in Extension 4-H and high school vocational agriculture programs in Pennsylvania.

These publications strive to provide the reader with balanced information concerning a particular enterprise. One possible outcome will be to dissuade the reader from pursuing an enterprise that not suited to their abilities or resource base. Because the publications are not meant to be "production guides", each publication contains a "For More Information" section. This section contains additional sources of information, including web sites that the reader can access for more in-depth information. Publications covering production of a crop or livestock contain detailed budget information. These budgets are developed to assist the reader with identifying the expenses they will incur if they choose to pursue the enterprise. A column for their estimated figures is included so they may adapt the budget to their operation.

The authors of the publications in the Agricultural Alternatives series include Extension and research faculty from Penn State University and land-grant institutions from neighboring states, county Extension educators, and farmers. By sharing their expertise, they make the Agricultural Alternatives series possible.

**Table 1. Increase in number of small farms from 2002 to 2007 and their importance as an extension clientele group (selected states).**

	Change	Number	Change			Farms	
Avg.	Farm	from	of	from	Farms	Part-time	with sales
<u>Size</u>	<u>size</u>	<u>2002</u>	<u>Farms</u>	<u>2002</u>	<u>&lt;50 acres</u>	<u>Farms</u>	<u>&lt;\$10,000</u>
(acres)	(%)	(%)	(%)	(%)	(%)		
CA	313.0 -9.7%	81,033	1.8%	64.9%	49.5%	46.6%	
DE	200.4 -11.3%	2,546	6.5%	41.9%	40.9%	41.0%	
IL	348.4 -6.9%	76,860	5.2%	25.8%	51.6%	46.9%	
NJ	71.0 -12.5%	10,327	4.1%	69.0%	55.2%	67.3%	
NY	197.4 -4.0%	36,352	-2.4%	23.4%	46.0%	54.6%	
PA	123.6 -7.2%	63,163	8.7%	32.4%	54.5%	61.5%	

(Source: 2007 *Census of Agriculture*)

# Soil Sampling to Direct Farm Management on Diverse Organic Farms

**Doug Collins, Craig Cogger, Andy Bary**

**Washington State University**

**Puyallup, WA 98371**

## **Objective**

Small farmers in Washington State indicate that soil fertility management is one of their highest priority information needs. Our objective is to provide farmers with tools and instructions to track changes in fertility and implement effective nutrient management plans through accurate and efficient soil sampling.

## **Introduction**

Soil samples provide useful information to farmers about the nutrient status, pH, cation exchange capacity, and organic matter content of their soils. To effectively direct application of soil amendments and fertilizers based on these data, soil samples should be taken from distinct management units. Management units are contiguous areas that are planted to the same crop at about the same time and have the same amendments applied to them. A management unit can be as narrow as the equipment used to apply amendments, such as a tractor width.

Because of the high spatial variation in plantings on typical small organic vegetable farms, it quickly becomes apparent that sampling each management unit each year is not economically realistic. We tested a method of sampling representative units from each field with the goal of describing on-farm variation in soil parameters and linking soil management practices to soil nutrient values.

## **Methods**

Soil samples were taken from 29 distinct management units at four different farm sites in King County, WA. All of the sites were sampled between September 20 and 24, 2010. Management units ranged in size from .035 to 1.16 acres and were sampled by compositing 15 subsamples (0-12 inches). Samples were air dried and shipped to a soil testing lab for a complete soil nutrient analysis. Farmer records were queried to record rate and timing of fertilizer and amendment applications in each of the sampled management units.

## **Results and Discussion**

The mix of plantings on diverse vegetable farms poses a challenge for linking farm management to soil sample results. To combat pests and meet market requirements, farmers may plant a single field to a dozen or more different crops which have a range of nutrient needs. Sampling on a field scale across different crops will generalize management practices and crop effects on soil properties.

If samples are taken on a management unit basis, then growers can link soil test results to their management and make appropriate changes to improve profitability and environmental stewardship. Soil test data indicated high or excessive nitrate in 41 percent of the management units tested a water quality hazard and economic loss. Western Washington soils typically have low pH and the median lime requirement was over 3 tons/acre (Figure 1).

Excess soil nitrate can be washed from the soil profile and contaminate ground and surface water. Nitrogen uptake (plant choice), fertilizer amount, fertilizer timing, and fertilizer type are all important in determining N use efficiency. N timing best explained the trend in fall nitrate in these soils. Where late-season fertilizer applications were made, average soil nitrate levels were the highest (Figure 2). A mid-season nitrate test can also be an effective tool to guide mid- and late-season fertilizer applications.

An Extension manual detailing the management zone approach for diverse vegetable farms is available (Collins, 2012).

### **Literature Cited**

Marx, E.S., J. Hart, and R.G. Stevens. 1999. Soil Test Interpretation Guide. Oregon State University, EC 1478.

Collins, D.P. 2012. Soil testing: A guide for farms with diverse vegetable crops. Washington State University Extension. EM050E.



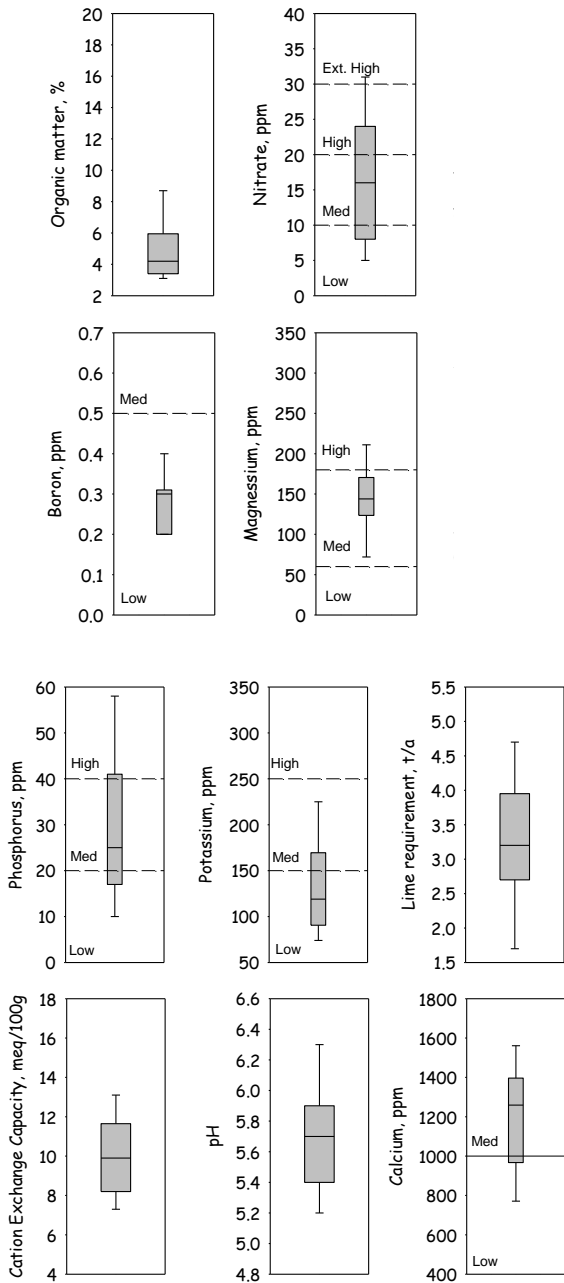

Figure 1. Box plot distributions of selected soil parameters across four farm sites. n=29. Plots show median (middle line), 25th and 75th percentiles (boxes) and 10th and 90th percentiles (whiskers). Interpretation guidelines (e.g. low, medium, high) and lime requirement are based on Marx, Hart, & Stevens, 1998 (OSU EC1478).

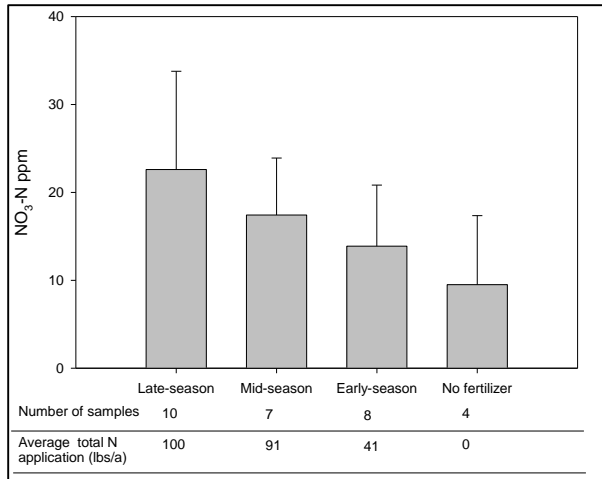

Figure 2. Fall soil nitrate levels by timing of fertilizer application. Mid-season = May-June; Early-season = March-April. Bars are standard deviation.

## Making All Farms is the First Count: Finding Them Step to Serving Them\*

**Barbara Rater, *State Statistician, USDA's National Agricultural Statistics Service (NASS) - Maryland***

USDA helps maintain economic stability in the agricultural sector. To help make rural America profitable, competitive and sustainable, NASS must deliver high-quality, objective, relevant, timely and accurate statistics that enable producers and other data users to make sound, informed production and marketing decisions. NASS conducts the Census of Agriculture every 5 years. The statistics give a snapshot of the agriculture economy by providing comprehensive information at the national, state, and county levels. Detailed county-level information is critical for developing local level strategies and plans. Most importantly, official statistics on agriculture promote a level playing field in production agriculture, with impartial information available to all at a pre-determined time.

To ensure our programs are representative and inclusive, NASS reaches out to traditionally underserved populations -- including minorities, women, socially disadvantaged, tribal and beginning farm operators – to improve coverage on our agricultural census. This would not be possible without our land-grant colleges and university partners, our federal partners, our state department of agriculture partners, our local program supporters and community-based organizational partners like the Rural Coalition.

In preparing for any census, one challenge we face is to developing strategies that will reach underrepresented farmers so programs adequately represent this segment of the agriculture community. My active involvement in this research project allowed me to implement a more effective outreach strategy in preparation for the 2012 Census of Agriculture. I developed new partnerships and gained a better understanding of the challenges faced by traditionally underserved communities. Now, I am better positioned to ensure racially and ethnically diverse populations are counted in the census and that published demographic data meet their needs.

When exploring solutions, the following outcomes resulted: the federal and state agencies gained a better understanding of the barriers and challenges facing Maryland farmers; stakeholders learned about *individual* outreach efforts and were able to better coordinate their efforts, in turn strengthening the effectiveness and benefits; the farmers at the table gained a better understanding of the federal agencies

---

\* Presented as part of a session on "Innovative Solutions to USDA Exclusions" at the 6<sup>th</sup> National Small Farm Conference, September 20, 2012, Memphis, TN. Direct correspondence to: Barbara Rater, Director/State Statistician, Maryland Field Office of the National Agricultural Statistics Service, Annapolis, MD 21401; 410-841-5740; Barbara.Rater@nass.usda.gov

trying to serve them; and the experience reinforced the importance of establishing and nourishing relationships and trust with the community we serve, and with each other.

The job of a state statistician for NASS is to serve the needs of the state's agricultural community by collecting and generating the complete, reliable statistics. USDA has a rich history of collecting and distributing agricultural statistics, dating back over 140 years. Our success depends on the partnerships we develop and cultivate and the voluntary cooperation of the farmer that takes valuable time to respond to our surveys.

## **USDA Natural Resources Conservation Service (NRCS) – Maryland: Outreach to Small and Beginning Farmers and Ranchers\***

Jon Hall, *State Conservationist, Maryland, USDA-NRCS*

NRCS – Maryland has demonstrated the agency's commitment to reach out to small and beginning farmers and ranchers. This has been done through news releases, workshops, and public speaking events. Significant new partnership groups collaborating in this effort have been the Rural Coalition, National Association of Latino Farmers and Ranchers, and Accokeek Foundation. Collaborative support has been received through partnerships with the Office of Advocacy and Outreach 1890 Liaison University of Maryland Eastern Shore, Maryland Cooperative Extension, Maryland Association of Soil Conservation Districts, Maryland Agricultural Statistics. Some significant grants, agreements, presentations and workshops include:

- Conservation Innovation Grant with Maryland Association of Soil Conservation Districts to implement Farm Bill program presentations to specific groups communicated in Korean and Vietnamese;
- Cooperative agreement with local Soil Conservation District to reach out to Plain Sect communities;
- Cooperative agreement with local University of Maryland Eastern Shore to reach out to urban agricultural producers;
- University of Maryland Eastern Shore -- Small Farm Conference;
- Presentations and exhibits at various community fairs and special rural community events; and,
- Maryland Department of Natural Resources, Division of Forestry.

A resulting outcome of the effort has effectively reached historically underserved groups. More than \$4.2 million of financial assistance was obligated to historically underserved producers, which is almost 20 percent of Maryland Financial Assistance Program obligations.

---

\* Presented as part of a session on "Innovative Solutions to USDA Exclusions" at the 6<sup>th</sup> National Small Farm Conference, September 20, 2012, Memphis, TN. Direct correspondence to: Jon Hall, State Conservationist, Maryland State Office of USDA/NRCS, Annapolis, MD 21409; 410-757-0816; Jon.Hall@md.usda.gov

**For more information about the Innovative Solutions project, please contact:**

Lorette Picciano, Executive Director  
Rural Coalition/Rural Coalición  
1029 Vermont Avenue, NW, Suite 601  
Washington, D.C. 20005  
202-628-7160; [www.ruralco.org](http://www.ruralco.org)  
[lpicciano@ruralco.org](mailto:lpicciano@ruralco.org)